

Apache HTTP Server Documentation Version 2.0

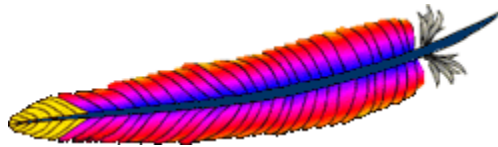

Apache Software Foundation

October 2, 2009

About The PDF Documentation

Copyright ©2005 The Apache Software Foundation

Licensed under the Apache License, Version 2.0 (the "License"); you may not use this file except in compliance with the License. You may obtain a copy of the License at <http://www.apache.org/licenses/LICENSE-2.0>

This version of the Apache HTTP Server Documentation is converted from XML source files to \LaTeX using XSLT with the help of Apache Ant, Apache XML Xalan, and Apache XML Xerces.

Since the HTML version of the documentation is more commonly checked during development, the PDF version may contain some errors and inconsistencies, especially in formatting. If you have difficulty reading a part of this file, please consult the HTML version of the documentation on the Apache HTTP Server website at <http://httpd.apache.org/docs/2.0/>

The Apache HTTP Server Documentation is maintained by the Apache HTTP Server Documentation Project. More information is available at <http://httpd.apache.org/docs-project/>

Contents

1	Release Notes	1
1.1	Upgrading to 2.0 from 1.3	2
1.2	Overview of new features in Apache 2.0	4
1.3	The Apache License, Version 2.0	6
2	Using the Apache HTTP Server	9
2.1	Compiling and Installing	10
2.2	Starting Apache	14
2.3	Stopping and Restarting	16
2.4	Configuration Files	19
2.5	Configuration Sections	21
2.6	Server-Wide Configuration	27
2.7	Log Files	29
2.8	Mapping URLs to Filesystem Locations	36
2.9	Security Tips	40
2.10	Dynamic Shared Object (DSO) Support	44
2.11	Content Negotiation	47
2.12	Custom Error Responses	54
2.13	Binding	57
2.14	Multi-Processing Modules (MPMs)	59
2.15	Environment Variables in Apache	60
2.16	Apache’s Handler Use	65
2.17	Filters	67
2.18	suEXEC Support	68
2.19	Apache Performance Tuning	73
2.20	URL Rewriting Guide	85
3	Apache Virtual Host documentation	109
3.1	Apache Virtual Host documentation	110

3.2	Name-based Virtual Host Support	111
3.3	Apache IP-based Virtual Host Support	114
3.4	Dynamically Configured Mass Virtual Hosting	116
3.5	VirtualHost Examples	121
3.6	An In-Depth Discussion of Virtual Host Matching	129
3.7	File Descriptor Limits	134
3.8	Issues Regarding DNS and Apache	136
4	Apache Server Frequently Asked Questions	139
4.1	Frequently Asked Questions	140
4.2	Support - Frequently Asked Questions	141
4.3	Error Messages - Frequently Asked Questions	143
5	Apache SSL/TLS Encryption	145
5.1	Apache SSL/TLS Encryption	146
5.2	SSL/TLS Strong Encryption: An Introduction	147
5.3	SSL/TLS Strong Encryption: Compatibility	156
5.4	SSL/TLS Strong Encryption: How-To	160
5.5	SSL/TLS Strong Encryption: FAQ	165
6	Guides, Tutorials, and HowTos	179
6.1	How-To / Tutorials	180
6.2	Authentication, Authorization and Access Control	181
6.3	Apache Tutorial: Dynamic Content with CGI	185
6.4	Apache Tutorial: Introduction to Server Side Includes	191
6.5	Apache Tutorial: .htaccess files	197
6.6	Per-user web directories	202
6.7	Apache Tutorials	204
7	Platform-specific Notes	207
7.1	Platform Specific Notes	208
7.2	Using Apache with Microsoft Windows	209
7.3	Compiling Apache for Microsoft Windows	218
7.4	Using Apache With Novell NetWare	223
7.5	Running a High-Performance Web Server on HPUX	229
7.6	The Apache EBCDIC Port	230
8	Apache HTTP Server and Supporting Programs	235
8.1	Server and Supporting Programs	236

8.2	httpd - Apache Hypertext Transfer Protocol Server	237
8.3	ab - Apache HTTP server benchmarking tool	239
8.4	apachectl - Apache HTTP Server Control Interface	241
8.5	apxs - APache eXtenSion tool	243
8.6	configure - Configure the source tree	247
8.7	dbmmanage - Manage user authentication files in DBM format	257
8.8	htdbm - Manipulate DBM password databases	259
8.9	htdigest - manage user files for digest authentication	262
8.10	htpasswd - Manage user files for basic authentication	263
8.11	logresolve - Resolve IP-addresses to hostnames in Apache log files	265
8.12	rotatelog - Piped logging program to rotate Apache logs	266
8.13	suexec - Switch user before executing external programs	268
8.14	Other Programs	269
9	Apache Miscellaneous Documentation	271
9.1	Apache Miscellaneous Documentation	272
9.2	International Customized Server Error Messages	273
9.3	Connections in the FIN_WAIT_2 state and Apache	281
9.4	Known Problems in Clients	286
9.5	Descriptors and Apache	291
9.6	Relevant Standards	294
10	Apache modules	297
10.1	Terms Used to Describe Modules	298
10.2	Terms Used to Describe Directives	299
10.3	Apache Module core	302
10.4	Apache Module mod_access	342
10.5	Apache Module mod_actions	346
10.6	Apache Module mod_alias	348
10.7	Apache Module mod_asis	353
10.8	Apache Module mod_auth	355
10.9	Apache Module mod_auth_anon	358
10.10	Apache Module mod_auth_dbm	361
10.11	Apache Module mod_auth_digest	364
10.12	Apache Module mod_auth_ldap	369
10.13	Apache Module mod_autoindex	380
10.14	Apache Module mod_cache	391
10.15	Apache Module mod_cern_meta	397

10.16	Apache Module mod_cgi	399
10.17	Apache Module mod_cgid	402
10.18	Apache Module mod_charset_lite	403
10.19	Apache Module mod_dav	406
10.20	Apache Module mod_dav_fs	410
10.21	Apache Module mod_deflate	411
10.22	Apache Module mod_dir	416
10.23	Apache Module mod_disk_cache	418
10.24	Apache Module mod_dumpio	423
10.25	Apache Module mod_echo	425
10.26	Apache Module mod_env	426
10.27	Apache Module mod_example	428
10.28	Apache Module mod_expires	430
10.29	Apache Module mod_ext_filter	433
10.30	Apache Module mod_file_cache	439
10.31	Apache Module mod_headers	442
10.32	Apache Module mod_imap	446
10.33	Apache Module mod_include	450
10.34	Apache Module mod_info	459
10.35	Apache Module mod_isapi	461
10.36	Apache Module mod_ldap	465
10.37	Apache Module mod_log_config	471
10.38	Apache Module mod_log_forensic	476
10.39	Apache Module mod_logio	478
10.40	Apache Module mod_mem_cache	479
10.41	Apache Module mod_mime	483
10.42	Apache Module mod_mime_magic	495
10.43	Apache Module mod_negotiation	499
10.44	Apache Module mod_nw_ssl	503
10.45	Apache Module mod_proxy	504
10.46	Apache Module mod_proxy_connect	518
10.47	Apache Module mod_proxy_ftp	519
10.48	Apache Module mod_proxy_http	520
10.49	Apache Module mod_rewrite	521
10.50	Apache Module mod_setenvif	541
10.51	Apache Module mod_so	545
10.52	Apache Module mod_speling	547

10.53	Apache Module mod_ssl	549
10.54	Apache Module mod_status	572
10.55	Apache Module mod_suexec	574
10.56	Apache Module mod_unique_id	575
10.57	Apache Module mod_userdir	577
10.58	Apache Module mod_usertrack	579
10.59	Apache Module mod_version	583
10.60	Apache Module mod_vhost_alias	585
10.61	Apache Module beos	589
10.62	Apache Module mpm_common	591
10.63	Apache Module leader	603
10.64	Apache Module mpm_netware	604
10.65	Apache Module mpmt_os2	606
10.66	Apache Module perchild	607
10.67	Apache Module prefork	611
10.68	Apache Module threadpool	614
10.69	Apache Module mpm_winnt	615
10.70	Apache Module worker	616
11	Developer Documentation	619
11.1	Developer Documentation for Apache 2.0	620
11.2	Apache 1.3 API notes	621
11.3	Debugging Memory Allocation in APR	637
11.4	Documenting Apache 2.0	640
11.5	Apache 2.0 Hook Functions	641
11.6	Converting Modules from Apache 1.3 to Apache 2.0	644
11.7	Request Processing in Apache 2.0	648
11.8	How filters work in Apache 2.0	652
12	Glossary and Index	655
12.1	Glossary	656
12.2	Module Index	660
12.3	Directive Index	663
12.4	Directive Quick Reference	672

Chapter 1

Release Notes

1.1 Upgrading to 2.0 from 1.3

In order to assist folks upgrading, we maintain a document describing information critical to existing Apache users. These are intended to be brief notes, and you should be able to find more information in either the New Features (p. 4) document, or in the `src/CHANGES` file.

See also

- Overview of new features in Apache 2.0 (p. 4)

Compile-Time Configuration Changes

- Apache now uses an `autoconf` and `libtool` system for configuring the build processes (p. 10). Using this system is similar to, but not the same as, using the APACI system in Apache 1.3.
- In addition to the usual selection of modules which you can choose to compile, Apache 2.0 has moved the main part of request processing into Multi-Processing Modules (p. 59) (MPMs).

Run-Time Configuration Changes

- Many directives that were in the core server in Apache 1.3 are now in the MPMs. If you wish the behavior of the server to be as similar as possible to the behavior of Apache 1.3, you should select the `PREFORK` MPM. Other MPMs will have different directives to control process creation and request processing.
- The proxy module (p. 504) has been revamped to bring it up to HTTP/1.1. Among the important changes, proxy access control is now placed inside a `<PROXY>` block rather than a `<Directory proxy:>` block.
- The handling of `PATH_INFO` (trailing path information after the true filename) has changed for some modules. Modules that were previously implemented as a handler but are now implemented as a filter may no longer accept requests with `PATH_INFO`. Filters such as `INCLUDES` (p. 450) or `PHP`¹ are implemented on top of the core handler, and therefore reject requests with `PATH_INFO`. You can use the `ACCEPTPATHINFO` directive to force the core handler to accept requests with `PATH_INFO` and thereby restore the ability to use `PATH_INFO` in server-side includes.
- The `CACHENEGOTIATEDDOCS` directive now takes the argument `on` or `off`. Existing instances of `CACHENEGOTIATEDDOCS` should be replaced with `CacheNegotiatedDocs on`.
- The `ERRORDOCUMENT` directive no longer uses a quote at the beginning of the argument to indicate a text message. Instead, you should enclose the message in double quotes. For example, existing instances of

```
ErrorDocument 403 "Some Message"
```

should be replaced with

```
ErrorDocument 403 "Some Message"
```

As long as the second argument is not a valid URL or pathname, it will be treated as a text message.

- The `AccessConfig` and `ResourceConfig` directives no longer exist. Existing instances of these directives can be replaced with the `INCLUDE` directive which has equivalent functionality. If you were making use of the default values of these directives without including them in the configuration files, you may need to add `Include conf/access.conf` and `Include conf/srm.conf` to your `httpd.conf`. In order to assure that Apache reads the configuration files in the same order as was implied by the older directives, the `INCLUDE` directives should be placed at the end of `httpd.conf`, with the one for `srm.conf` preceding the one for `access.conf`.

¹<http://www.php.net/>

- The `BindAddress` and `Port` directives no longer exist. Equivalent functionality is provided with the more flexible `LISTEN` directive.
- Another use of the `Port` directive in Apache-1.3 was setting the port number to be used in self-referential URL's. The Apache-2.0 equivalent is the new `SERVERNAME` syntax: it has been changed to allow specifying both the hostname *and* the port number for self-referential URL's in one directive.
- The `ServerType` directive no longer exists. The method used to serve requests is now determined by the selection of MPM. There is currently no MPM designed to be launched by `inetd`.
- The `mod_log_agent` and `mod_log_referer` modules which provided the `AgentLog`, `RefererLog` and `RefererIgnore` directives have been removed. Agent and referer logs are still available using the `CUSTOM-LOG` directive of `MOD_LOG_CONFIG`.
- The `AddModule` and `ClearModuleList` directives no longer exist. These directives were used to ensure that modules could be enabled in the correct order. The new Apache 2.0 API allows modules to explicitly specify their ordering, eliminating the need for these directives.
- The `FancyIndexing` directive has been removed. The same functionality is available through the `FancyIndexing` option to the `INDEXOPTIONS` directive.
- The MultiViews content-negotiation technique provided by `MOD_NEGOTIATION` has become more strict in its default file matching. It will select only from *negotiable* files. The old behavior can be restored using the `MULTIVIEWSMATCH` directive.
- (since version 2.0.51) The functionality of the `ErrorHeader` directive was put together with the `HEADER` directive, since it was a misnomer. Use

```
Header always set foo bar
```

instead to get the desired behaviour.

Misc Changes

- The module `MOD_AUTH_DIGEST`, which was experimental in Apache 1.3, is now a standard module.
- The `mod_mmap_static` module, which was experimental in Apache 1.3, has been replaced with `MOD_FILE_CACHE`.
- The distribution has been completely reorganized so that it no longer contains an independent `src` directory. Instead, the sources are logically organized under the main distribution directory, and installations of the compiled server should be directed to a separate directory.

Third Party Modules

Extensive changes were made to the server API in Apache 2.0. Existing modules designed for the Apache 1.3 API will **not** work in Apache 2.0 without modification. Details are provided in the developer documentation (p. 620).

1.2 Overview of new features in Apache 2.0

This document describes some of the major changes between the 1.3 and 2.0 versions of the Apache HTTP Server.

See also

- [Upgrading to 2.0 from 1.3 \(p. 2\)](#)

Core Enhancements

Unix Threading On Unix systems with POSIX threads support, Apache can now run in a hybrid multiprocess, multithreaded mode. This improves scalability for many, but not all configurations.

New Build System The build system has been rewritten from scratch to be based on `autoconf` and `libtool`. This makes Apache's configuration system more similar to that of other packages.

Multiprotocol Support Apache now has some of the infrastructure in place to support serving multiple protocols. `MOD_ECHO` has been written as an example.

Better support for non-Unix platforms Apache 2.0 is faster and more stable on non-Unix platforms such as BeOS, OS/2, and Windows. With the introduction of platform-specific multi-processing modules (p. 59) (MPMs) and the Apache Portable Runtime (APR), these platforms are now implemented in their native API, avoiding the often buggy and poorly performing POSIX-emulation layers.

New Apache API The API for modules has changed significantly for 2.0. Many of the module-ordering/-priority problems from 1.3 should be gone. 2.0 does much of this automatically, and module ordering is now done per-hook to allow more flexibility. Also, new calls have been added that provide additional module capabilities without patching the core Apache server.

IPv6 Support On systems where IPv6 is supported by the underlying Apache Portable Runtime library, Apache gets IPv6 listening sockets by default. Additionally, the `LISTEN`, `NAMEVIRTUALHOST`, and `VIRTUALHOST` directives support IPv6 numeric address strings (e.g., "Listen [2001:db8::1]:8080").

Filtering Apache modules may now be written as filters which act on the stream of content as it is delivered to or from the server. This allows, for example, the output of CGI scripts to be parsed for Server Side Include directives using the `INCLUDES` filter in `MOD_INCLUDE`. The module `MOD_EXT_FILTER` allows external programs to act as filters in much the same way that CGI programs can act as handlers.

Multilanguage Error Responses Error response messages to the browser are now provided in several languages, using SSI documents. They may be customized by the administrator to achieve a consistent look and feel.

Simplified configuration Many confusing directives have been simplified. The often confusing `Port` and `BindAddress` directives are gone; only the `LISTEN` directive is used for IP address binding; the `SERVER-NAME` directive specifies the server name and port number only for redirection and vhost recognition.

Native Windows NT Unicode Support Apache 2.0 on Windows NT now uses utf-8 for all filename encodings. These directly translate to the underlying Unicode file system, providing multilanguage support for all Windows NT-based installations, including Windows 2000 and Windows XP. *This support does not extend to Windows 95, 98 or ME, which continue to use the machine's local codepage for filesystem access.*

Regular Expression Library Updated Apache 2.0 includes the Perl Compatible Regular Expression Library² (PCRE). All regular expression evaluation now uses the more powerful Perl 5 syntax.

²<http://www.pcre.org/>

Module Enhancements

MOD_SSL New module in Apache 2.0. This module is an interface to the SSL/TLS encryption protocols provided by OpenSSL.

MOD_DAV New module in Apache 2.0. This module implements the HTTP Distributed Authoring and Versioning (DAV) specification for posting and maintaining web content.

MOD_DEFLATE New module in Apache 2.0. This module allows supporting browsers to request that content be compressed before delivery, saving network bandwidth.

MOD_AUTH_LDAP New module in Apache 2.0.41. This module allows an LDAP database to be used to store credentials for HTTP Basic Authentication. A companion module, **MOD_LDAP** provides connection pooling and results caching.

MOD_AUTH_DIGEST Includes additional support for session caching across processes using shared memory.

MOD_CHARSET_LITE New module in Apache 2.0. This experimental module allows for character set translation or recoding.

MOD_FILE_CACHE New module in Apache 2.0. This module includes the functionality of `mod_mmap_static` in Apache 1.3, plus adds further caching abilities.

MOD_HEADERS This module is much more flexible in Apache 2.0. It can now modify request headers used by **MOD_PROXY**, and it can conditionally set response headers.

MOD_PROXY The proxy module has been completely rewritten to take advantage of the new filter infrastructure and to implement a more reliable, HTTP/1.1 compliant proxy. In addition, new `<PROXY>` configuration sections provide more readable (and internally faster) control of proxied sites; overloaded `<Directory "proxy:...">` configuration are not supported. The module is now divided into specific protocol support modules including `proxy_connect`, `proxy_ftp` and `proxy_http`.

MOD_NEGOTIATION A new `FORCELANGUAGEPRIORITY` directive can be used to assure that the client receives a single document in all cases, rather than NOT ACCEPTABLE or MULTIPLE CHOICES responses. In addition, the negotiation and MultiViews algorithms have been cleaned up to provide more consistent results and a new form of type map that can include document content is provided.

MOD_AUTOINDEX Autoindex'ed directory listings can now be configured to use HTML tables for cleaner formatting, and allow finer-grained control of sorting, including version-sorting, and wildcard filtering of the directory listing.

MOD_INCLUDE New directives allow the default start and end tags for SSI elements to be changed and allow for error and time format configuration to take place in the main configuration file rather than in the SSI document. Results from regular expression parsing and grouping (now based on Perl's regular expression syntax) can be retrieved using **MOD_INCLUDE**'s variables `$_0 .. $_9`.

MOD_AUTH_DBM Now supports multiple types of DBM-like databases using the `AUTHDBMTYPE` directive.

1.3 The Apache License, Version 2.0

Apache License
Version 2.0, January 2004
<http://www.apache.org/licenses/>

TERMS AND CONDITIONS FOR USE, REPRODUCTION, AND DISTRIBUTION

1. Definitions

"License" shall mean the terms and conditions for use, reproduction, and distribution as defined by Sections 1 through 9 of this document.

"Licensor" shall mean the copyright owner or entity authorized by the copyright owner that is granting the License.

"Legal Entity" shall mean the union of the acting entity and all other entities that control, are controlled by, or are under common control with that entity. For the purposes of this definition, "control" means (i) the power, direct or indirect, to cause the direction or management of such entity, whether by contract or otherwise, or (ii) ownership of fifty percent (50%) or more of the outstanding shares, or (iii) beneficial ownership of such entity.

"You" (or "Your") shall mean an individual or Legal Entity exercising permissions granted by this License.

"Source" form shall mean the preferred form for making modifications, including but not limited to software source code, documentation source, and configuration files.

"Object" form shall mean any form resulting from mechanical transformation or translation of a Source form, including but not limited to compiled object code, generated documentation, and conversions to other media types.

"Work" shall mean the work of authorship, whether in Source or Object form, made available under the License, as indicated by a copyright notice that is included in or attached to the work (an example is provided in the Appendix below).

"Derivative Works" shall mean any work, whether in Source or Object form, that is based on (or derived from) the Work and for which the editorial revisions, annotations, elaborations, or other modifications represent, as a whole, an original work of authorship. For the purposes of this License, Derivative Works shall not include works that remain separable from, or merely link (or bind by name) to the interfaces of, the Work and Derivative Works thereof.

"Contribution" shall mean any work of authorship, including the original version of the Work and any modifications or additions to that Work or Derivative Works thereof, that is intentionally submitted to Licensor for inclusion in the Work by the copyright owner or by an individual or Legal Entity authorized to submit on behalf of the copyright owner. For the purposes of this definition, "submitted" means any form of electronic, verbal, or written communication sent to the Licensor or its representatives, including but not limited to communication on electronic mailing lists, source code control systems, and issue tracking systems that are managed by, or on behalf of, the Licensor for the purpose of discussing and improving the Work, but excluding communication that is conspicuously marked or otherwise designated in writing by the copyright owner as "Not a Contribution."

"Contributor" shall mean Licensor and any individual or Legal Entity on behalf of whom a Contribution has been received by Licensor and subsequently incorporated within the Work.

- 2. Grant of Copyright License.** Subject to the terms and conditions of this License, each Contributor hereby grants to You a perpetual, worldwide, non-exclusive, no-charge, royalty-free, irrevocable copyright license to reproduce, prepare Derivative Works of, publicly display, publicly perform, sublicense, and distribute the Work and such Derivative Works in Source or Object form.
- 3. Grant of Patent License.** Subject to the terms and conditions of this License, each Contributor hereby grants to You a perpetual, worldwide, non-exclusive, no-charge, royalty-free, irrevocable (except as stated in this section)

patent license to make, have made, use, offer to sell, sell, import, and otherwise transfer the Work, where such license applies only to those patent claims licensable by such Contributor that are necessarily infringed by their Contribution(s) alone or by combination of their Contribution(s) with the Work to which such Contribution(s) was submitted. If You institute patent litigation against any entity (including a cross-claim or counterclaim in a lawsuit) alleging that the Work or a Contribution incorporated within the Work constitutes direct or contributory patent infringement, then any patent licenses granted to You under this License for that Work shall terminate as of the date such litigation is filed.

4. **Redistribution.** You may reproduce and distribute copies of the Work or Derivative Works thereof in any medium, with or without modifications, and in Source or Object form, provided that You meet the following conditions:
 - (a) You must give any other recipients of the Work or Derivative Works a copy of this License; and
 - (b) You must cause any modified files to carry prominent notices stating that You changed the files; and
 - (c) You must retain, in the Source form of any Derivative Works that You distribute, all copyright, patent, trademark, and attribution notices from the Source form of the Work, excluding those notices that do not pertain to any part of the Derivative Works; and
 - (d) If the Work includes a "NOTICE" text file as part of its distribution, then any Derivative Works that You distribute must include a readable copy of the attribution notices contained within such NOTICE file, excluding those notices that do not pertain to any part of the Derivative Works, in at least one of the following places: within a NOTICE text file distributed as part of the Derivative Works; within the Source form or documentation, if provided along with the Derivative Works; or, within a display generated by the Derivative Works, if and wherever such third-party notices normally appear. The contents of the NOTICE file are for informational purposes only and do not modify the License. You may add Your own attribution notices within Derivative Works that You distribute, alongside or as an addendum to the NOTICE text from the Work, provided that such additional attribution notices cannot be construed as modifying the License.

You may add Your own copyright statement to Your modifications and may provide additional or different license terms and conditions for use, reproduction, or distribution of Your modifications, or for any such Derivative Works as a whole, provided Your use, reproduction, and distribution of the Work otherwise complies with the conditions stated in this License.

5. **Submission of Contributions.** Unless You explicitly state otherwise, any Contribution intentionally submitted for inclusion in the Work by You to the Licensor shall be under the terms and conditions of this License, without any additional terms or conditions. Notwithstanding the above, nothing herein shall supersede or modify the terms of any separate license agreement you may have executed with Licensor regarding such Contributions.
6. **Trademarks.** This License does not grant permission to use the trade names, trademarks, service marks, or product names of the Licensor, except as required for reasonable and customary use in describing the origin of the Work and reproducing the content of the NOTICE file.
7. **Disclaimer of Warranty.** Unless required by applicable law or agreed to in writing, Licensor provides the Work (and each Contributor provides its Contributions) on an "AS IS" BASIS, WITHOUT WARRANTIES OR CONDITIONS OF ANY KIND, either express or implied, including, without limitation, any warranties or conditions of TITLE, NON-INFRINGEMENT, MERCHANTABILITY, or FITNESS FOR A PARTICULAR PURPOSE. You are solely responsible for determining the appropriateness of using or redistributing the Work and assume any risks associated with Your exercise of permissions under this License.
8. **Limitation of Liability.** In no event and under no legal theory, whether in tort (including negligence), contract, or otherwise, unless required by applicable law (such as deliberate and grossly negligent acts) or agreed to in writing, shall any Contributor be liable to You for damages, including any direct, indirect, special, incidental, or consequential damages of any character arising as a result of this License or out of the use or inability to use the Work (including but not limited to damages for loss of goodwill, work stoppage, computer failure or malfunction, or any and all other commercial damages or losses), even if such Contributor has been advised of the possibility of such damages.

- 9. Accepting Warranty or Additional Liability.** While redistributing the Work or Derivative Works thereof, You may choose to offer, and charge a fee for, acceptance of support, warranty, indemnity, or other liability obligations and/or rights consistent with this License. However, in accepting such obligations, You may act only on Your own behalf and on Your sole responsibility, not on behalf of any other Contributor, and only if You agree to indemnify, defend, and hold each Contributor harmless for any liability incurred by, or claims asserted against, such Contributor by reason of your accepting any such warranty or additional liability.

END OF TERMS AND CONDITIONS

APPENDIX: How to apply the Apache License to your work.

To apply the Apache License to your work, attach the following boilerplate notice, with the fields enclosed by brackets "[]" replaced with your own identifying information. (Don't include the brackets!) The text should be enclosed in the appropriate comment syntax for the file format. We also recommend that a file or class name and description of purpose be included on the same "printed page" as the copyright notice for easier identification within third-party archives.

```
Copyright [yyyy] [name of copyright owner]
```

```
Licensed under the Apache License, Version 2.0 (the "License");  
you may not use this file except in compliance with the License.  
You may obtain a copy of the License at
```

```
http://www.apache.org/licenses/LICENSE-2.0
```

```
Unless required by applicable law or agreed to in writing, software  
distributed under the License is distributed on an "AS IS" BASIS,  
WITHOUT WARRANTIES OR CONDITIONS OF ANY KIND, either express or implied.  
See the License for the specific language governing permissions and  
limitations under the License.
```

Chapter 2

Using the Apache HTTP Server

2.1 Compiling and Installing

This document covers compilation and installation of Apache on Unix and Unix-like systems only. For compiling and installation on Windows, see Using Apache with Microsoft Windows (p. 209) . For other platforms, see the platform (p. 208) documentation.

Apache 2.0's configuration and installation environment has changed completely from Apache 1.3. Apache 1.3 used a custom set of scripts to achieve easy installation. Apache 2.0 now uses `libtool` and `autoconf` to create an environment that looks like many other Open Source projects.

If you are upgrading from one minor version to the next (for example, 2.0.50 to 2.0.51), please skip down to the upgrading section.

See also

- Configure the source tree (p. 247)
- Starting Apache (p. 14)
- Stopping and Restarting (p. 16)

Overview for the impatient

Download	\$ <code>lynx http://httpd.apache.org/download.cgi</code>
Extract	\$ <code>gzip -d httpd-2.0_XX.tar.gz</code> \$ <code>tar xvf httpd-2.0_XX.tar</code>
Configure	\$ <code>./configure --prefix=PREFIX</code>
Compile	\$ <code>make</code>
Install	\$ <code>make install</code>
Customize	\$ <code>vi PREFIX/conf/httpd.conf</code>
Test	\$ <code>PREFIX/bin/apachectl start</code>

XX must be replaced with the current minor version number, and *PREFIX* must be replaced with the filesystem path under which the server should be installed. If *PREFIX* is not specified, it defaults to `/usr/local/apache2`.

Each section of the compilation and installation process is described in more detail below, beginning with the requirements for compiling and installing Apache HTTPD.

Requirements

The following requirements exist for building Apache:

Disk Space Make sure you have at least 50 MB of temporary free disk space available. After installation Apache occupies approximately 10 MB of disk space. The actual disk space requirements will vary considerably based on your chosen configuration options and any third-party modules.

ANSI-C Compiler and Build System Make sure you have an ANSI-C compiler installed. The GNU C compiler (GCC)¹ from the Free Software Foundation (FSF)² is recommended (version 2.7.2 is fine). If you don't have GCC then at least make sure your vendor's compiler is ANSI compliant. In addition, your `PATH` must contain basic build tools such as `make`.

Accurate time keeping Elements of the HTTP protocol are expressed as the time of day. So, it's time to investigate setting some time synchronization facility on your system. Usually the `ntpd` or `xntpd` programs

¹<http://www.gnu.org/software/gcc/gcc.html>

²<http://www.gnu.org/>

are used for this purpose which are based on the Network Time Protocol (NTP). See the Usenet newsgroup comp.protocols.time.ntp³ and the NTP homepage⁴ for more details about NTP software and public time servers.

Perl 5⁵ [OPTIONAL] For some of the support scripts like `apxs` or `dbmmanage` (which are written in Perl) the Perl 5 interpreter is required (versions 5.003 or newer are sufficient). If you have multiple Perl interpreters (for example, a systemwide install of Perl 4, and your own install of Perl 5), you are advised to use the `--with-perl` option (see below) to make sure the correct one is used by `configure`. If no Perl 5 interpreter is found by the `configure` script, you will not be able to use the affected support scripts. Of course, you will still be able to build and use Apache 2.0.

Download

Apache can be downloaded from the Apache HTTP Server download site⁶ which lists several mirrors. Most users of Apache on unix-like systems will be better off downloading and compiling a source version. The build process (described below) is easy, and it allows you to customize your server to suit your needs. In addition, binary releases are often not up to date with the latest source releases. If you do download a binary, follow the instructions in the `INSTALL.bindist` file inside the distribution.

After downloading, it is important to verify that you have a complete and unmodified version of the Apache HTTP Server. This can be accomplished by testing the downloaded tarball against the PGP signature. Details on how to do this are available on the download page⁷ and an extended example is available describing the use of PGP⁸.

Extract

Extracting the source from the Apache HTTPD tarball is a simple matter of uncompressing, and then untarring:

```
$ gzip -d httpd-2.0_NN.tar.gz
$ tar xvf httpd-2.0_NN.tar
```

This will create a new directory under the current directory containing the source code for the distribution. You should `cd` into that directory before proceeding with compiling the server.

Configuring the source tree

The next step is to configure the Apache source tree for your particular platform and personal requirements. This is done using the script `configure` included in the root directory of the distribution. (Developers downloading the CVS version of the Apache source tree will need to have `autoconf` and `libtool` installed and will need to run `buildconf` before proceeding with the next steps. This is not necessary for official releases.)

To configure the source tree using all the default options, simply type `./configure`. To change the default options, `configure` accepts a variety of variables and command line options.

The most important option is the location `--prefix` where Apache is to be installed later, because Apache has to be configured for this location to work correctly. More fine-tuned control of the location of files is possible with additional `configure` options (p. 247).

Also at this point, you can specify which features (p. 247) you want included in Apache by enabling and disabling modules (p. 660). Apache comes with a Base (p. 298) set of modules included by default. Other modules are enabled

³news:comp.protocols.time.ntp

⁴<http://www.ntp.org>

⁶<http://httpd.apache.org/download.cgi>

⁷<http://httpd.apache.org/download.cgi#verify>

⁸<http://httpd.apache.org/dev/verification.html>

using the `--enable-module` option, where `module` is the name of the module with the `mod_` string removed and with any underscore converted to a dash. You can also choose to compile modules as shared objects (DSOs) (p. 44) – which can be loaded or unloaded at runtime – by using the option `--enable-module=shared`. Similarly, you can disable Base modules with the `--disable-module` option. Be careful when using these options, since `configure` cannot warn you if the module you specify does not exist; it will simply ignore the option.

In addition, it is sometimes necessary to provide the `configure` script with extra information about the location of your compiler, libraries, or header files. This is done by passing either environment variables or command line options to `configure`. For more information, see the `configure` manual page.

For a short impression of what possibilities you have, here is a typical example which compiles Apache for the installation tree `/sw/pkg/apache` with a particular compiler and flags plus the two additional modules `MOD_REWRITE` and `MOD_SPELLING` for later loading through the DSO mechanism:

```
$ CC="pgcc" CFLAGS="-O2" \  
./configure --prefix=/sw/pkg/apache \  
--enable-rewrite=shared \  
--enable-spelling=shared
```

When `configure` is run it will take several minutes to test for the availability of features on your system and build Makefiles which will later be used to compile the server.

Details on all the different `configure` options are available on the `configure` manual page.

Build

Now you can build the various parts which form the Apache package by simply running the command:

```
$ make
```

Please be patient here, since a base configuration takes approximately 3 minutes to compile under a Pentium III/Linux 2.2 system, but this will vary widely depending on your hardware and the number of modules which you have enabled.

Install

Now it's time to install the package under the configured installation *PREFIX* (see `--prefix` option above) by running:

```
$ make install
```

If you are upgrading, the installation will not overwrite your configuration files or documents.

Customize

Next, you can customize your Apache HTTP server by editing the configuration files (p. 19) under `PREFIX/conf/`.

```
$ vi PREFIX/conf/httpd.conf
```

Have a look at the Apache manual under `docs/manual/` (p. ??) or consult <http://httpd.apache.org/docs/2.0/> for the most recent version of this manual and a complete reference of available configuration directives (p. 663) .

Test

Now you can start (p. 14) your Apache HTTP server by immediately running:

```
$ PREFIX/bin/apachectl start
```

and then you should be able to request your first document via URL `http://localhost/`. The web page you see is located under the `DOCUMENTROOT` which will usually be `PREFIX/htdocs/`. Then stop (p. 16) the server again by running:

```
$ PREFIX/bin/apachectl stop
```

Upgrading

The first step in upgrading is to read the release announcement and the file `CHANGES` in the source distribution to find any changes that may affect your site. When changing between major releases (for example, from 1.3 to 2.0 or from 2.0 to 2.2), there will likely be major differences in the compile-time and run-time configuration that will require manual adjustments. All modules will also need to be upgraded to accommodate changes in the module API.

Upgrading from one minor version to the next (for example, from 2.0.55 to 2.0.57) is easier. The `make install` process will not overwrite any of your existing documents, log files, or configuration files. In addition, the developers make every effort to avoid incompatible changes in the configure options, run-time configuration, or the module API between minor versions. In most cases you should be able to use an identical configure command line, an identical configuration file, and all of your modules should continue to work. (This is only valid for versions after 2.0.41; earlier versions have incompatible changes.)

To upgrade across minor versions, start by finding the file `config.nice` in the `build` directory of your installed server or at the root of the source tree for your old install. This will contain the exact configure command line that you used to configure the source tree. Then to upgrade from one version to the next, you need only copy the `config.nice` file to the source tree of the new version, edit it to make any desired changes, and then run:

```
$ ./config.nice
$ make
$ make install
$ PREFIX/bin/apachectl stop
$ PREFIX/bin/apachectl start
```



You should always test any new version in your environment before putting it into production. For example, you can install and run the new version along side the old one by using a different `--prefix` and a different port (by adjusting the `LISTEN` directive) to test for any incompatibilities before doing the final upgrade.

2.2 Starting Apache

On Windows, Apache is normally run as a service on Windows NT, 2000 and XP, or as a console application on Windows 9x and ME. For details, see [Running Apache as a Service \(p. 209\)](#) and [Running Apache as a Console Application \(p. 209\)](#).

On Unix, the `httpd` program is run as a daemon that executes continuously in the background to handle requests. This document describes how to invoke `httpd`.

See also

- [Stopping and Restarting \(p. 16\)](#)
- `httpd`
- `apachectl`

How Apache Starts

If the `LISTEN` specified in the configuration file is default of 80 (or any other port below 1024), then it is necessary to have root privileges in order to start apache, so that it can bind to this privileged port. Once the server has started and performed a few preliminary activities such as opening its log files, it will launch several *child* processes which do the work of listening for and answering requests from clients. The main `httpd` process continues to run as the root user, but the child processes run as a less privileged user. This is controlled by the selected Multi-Processing Module (p. 59).

The recommended method of invoking the `httpd` executable is to use the `apachectl` control script. This script sets certain environment variables that are necessary for `httpd` to function correctly under some operating systems, and then invokes the `httpd` binary. `apachectl` will pass through any command line arguments, so any `httpd` options may also be used with `apachectl`. You may also directly edit the `apachectl` script by changing the `HTTPD` variable near the top to specify the correct location of the `httpd` binary and any command-line arguments that you wish to be *always* present.

The first thing that `httpd` does when it is invoked is to locate and read the configuration file (p. 19) `httpd.conf`. The location of this file is set at compile-time, but it is possible to specify its location at run time using the `-f` command-line option as in

```
/usr/local/apache2/bin/apachectl -f  
/usr/local/apache2/conf/httpd.conf
```

If all goes well during startup, the server will detach from the terminal and the command prompt will return almost immediately. This indicates that the server is up and running. You can then use your browser to connect to the server and view the test page in the `DOCUMENTROOT` directory and the local copy of the documentation linked from that page.

Errors During Start-up

If Apache suffers a fatal problem during startup, it will write a message describing the problem either to the console or to the `ERRORLOG` before exiting. One of the most common error messages is "Unable to bind to Port . . .". This message is usually caused by either:

- Trying to start the server on a privileged port when not logged in as the root user; or
- Trying to start the server when there is another instance of Apache or some other web server already bound to the same Port.

For further trouble-shooting instructions, consult the Apache FAQ (p. 140).

Starting at Boot-Time

If you want your server to continue running after a system reboot, you should add a call to `apachectl` to your system startup files (typically `rc.local` or a file in an `rc.N` directory). This will start Apache as root. Before doing this ensure that your server is properly configured for security and access restrictions.

The `apachectl` script is designed to act like a standard SysV init script; it can take the arguments `start`, `restart`, and `stop` and translate them into the appropriate signals to `httpd`. So you can often simply link `apachectl` into the appropriate init directory. But be sure to check the exact requirements of your system.

Additional Information

Additional information about the command-line options of `httpd` and `apachectl` as well as other support programs included with the server is available on the Server and Supporting Programs (p. 236) page. There is also documentation on all the modules (p. 660) included with the Apache distribution and the directives (p. 663) that they provide.

2.3 Stopping and Restarting

This document covers stopping and restarting Apache on Unix-like systems. Windows NT, 2000 and XP users should see Running Apache as a Service (p. 209) and Windows 9x and ME users should see Running Apache as a Console Application (p. 209) for information on how to control Apache on those platforms.

See also

- `httpd`
- `apachectl`
- Starting (p. 14)

Introduction

In order to stop or restart Apache, you must send a signal to the running `httpd` processes. There are two ways to send the signals. First, you can use the unix `kill` command to directly send signals to the processes. You will notice many `httpd` executables running on your system, but you should not send signals to any of them except the parent, whose pid is in the `PIDFILE`. That is to say you shouldn't ever need to send signals to any process except the parent. There are three signals that you can send the parent: `TERM`, `HUP`, and `USR1`, which will be described in a moment.

To send a signal to the parent you should issue a command such as:

```
kill -TERM `cat /usr/local/apache2/logs/httpd.pid`
```

The second method of signaling the `httpd` processes is to use the `-k` command line options: `stop`, `restart`, and `graceful`, as described below. These are arguments to the `httpd` binary, but we recommend that you send them using the `apachectl` control script, which will pass them through to `httpd`.

After you have signaled `httpd`, you can read about its progress by issuing:

```
tail -f /usr/local/apache2/logs/error.log
```

Modify those examples to match your `SERVERROOT` and `PIDFILE` settings.

Stop Now

Signal: `TERM` `apachectl -k stop`

Sending the `TERM` or `stop` signal to the parent causes it to immediately attempt to kill off all of its children. It may take it several seconds to complete killing off its children. Then the parent itself exits. Any requests in progress are terminated, and no further requests are served.

Graceful Restart

Signal: `USR1` `apachectl -k graceful`

The `USR1` or `graceful` signal causes the parent process to *advise* the children to exit after their current request (or to exit immediately if they're not serving anything). The parent re-reads its configuration files and re-opens its log files. As each child dies off the parent replaces it with a child from the new *generation* of the configuration, which begins serving new requests immediately.

⇒ On certain platforms that do not allow `USR1` to be used for a graceful restart, an alternative signal may be used (such as `WINCH`). The command `apachectl graceful` will send the right signal for your platform.

This code is designed to always respect the process control directive of the MPMs, so the number of processes and threads available to serve clients will be maintained at the appropriate values throughout the restart process. Furthermore, it respects `STARTSERVERS` in the following manner: if after one second at least `STARTSERVERS` new children have not been created, then create enough to pick up the slack. Hence the code tries to maintain both the number of children appropriate for the current load on the server, and respect your wishes with the `STARTSERVERS` parameter.

Users of `MOD_STATUS` will notice that the server statistics are **not** set to zero when a `USR1` is sent. The code was written to both minimize the time in which the server is unable to serve new requests (they will be queued up by the operating system, so they're not lost in any event) and to respect your tuning parameters. In order to do this it has to keep the `scoreboard` used to keep track of all children across generations.

The status module will also use a `G` to indicate those children which are still serving requests started before the graceful restart was given.

At present there is no way for a log rotation script using `USR1` to know for certain that all children writing the pre-restart log have finished. We suggest that you use a suitable delay after sending the `USR1` signal before you do anything with the old log. For example if most of your hits take less than 10 minutes to complete for users on low bandwidth links then you could wait 15 minutes before doing anything with the old log.

⇒ If your configuration file has errors in it when you issue a restart then your parent will not restart, it will exit with an error. In the case of graceful restarts it will also leave children running when it exits. (These are the children which are "gracefully exiting" by handling their last request.) This will cause problems if you attempt to restart the server – it will not be able to bind to its listening ports. Before doing a restart, you can check the syntax of the configuration files with the `-t` command line argument (see `httpd`). This still will not guarantee that the server will restart correctly. To check the semantics of the configuration files as well as the syntax, you can try starting `httpd` as a non-root user. If there are no errors it will attempt to open its sockets and logs and fail because it's not root (or because the currently running `httpd` already has those ports bound). If it fails for any other reason then it's probably a config file error and the error should be fixed before issuing the graceful restart.

Restart Now

Signal: `HUP` `apachectl -k restart`

Sending the `HUP` or `restart` signal to the parent causes it to kill off its children like in `TERM`, but the parent doesn't exit. It re-reads its configuration files, and re-opens any log files. Then it spawns a new set of children and continues serving hits.

Users of `MOD_STATUS` will notice that the server statistics are set to zero when a `HUP` is sent.

⇒ If your configuration file has errors in it when you issue a restart then your parent will not restart, it will exit with an error. See above for a method of avoiding this.

Appendix: signals and race conditions

Prior to Apache 1.2b9 there were several *race conditions* involving the restart and die signals (a simply put, a race condition is a time-sensitive problem - if something happens at just the wrong time or things happen in the wrong order, undesired behaviour will result. If the same thing happens at the right time, all will be well). For those architectures that have the "right" feature set we have eliminated as many as we can. But it should be noted that race conditions do still exist on certain architectures.

Architectures that use an on-disk [SCOREBOARDFILE](#) can potentially have their scoreboards corrupted. This can result in the "bind: Address already in use" (after HUP) or "long lost child came home!" (after USR1). The former is a fatal error, while the latter just causes the server to lose a scoreboard slot. So it may be advisable to use graceful restarts, with an occasional hard restart. These problems are very difficult to work around, but fortunately most architectures do not require a scoreboard file. See the [SCOREBOARDFILE](#) documentation for architecture which uses it.

All architectures have a small race condition in each child involving the second and subsequent requests on a persistent HTTP connection (KeepAlive). It may exit after reading the request line but before reading any of the request headers. There is a fix that was discovered too late to make 1.2. In theory this isn't an issue because the KeepAlive client has to expect these events because of network latencies and server timeouts. In practice it doesn't seem to affect anything either – in a test case the server was restarted twenty times per second and clients successfully browsed the site without getting broken images or empty documents.

2.4 Configuration Files

This document describes the files used to configure the Apache HTTP server.

Main Configuration Files

Related Modules	Related Directives
MOD_MIME	<IFDEF> INCLUDE TYPESCONFIG

Apache is configured by placing directives (p. 663) in plain text configuration files. The main configuration file is usually called `httpd.conf`. The location of this file is set at compile-time, but may be overridden with the `-f` command line flag. In addition, other configuration files may be added using the [INCLUDE](#) directive, and wildcards can be used to include many configuration files. Any directive may be placed in any of these configuration files. Changes to the main configuration files are only recognized by Apache when it is started or restarted.

The server also reads a file containing mime document types; the filename is set by the [TYPESCONFIG](#) directive, and is `mime.types` by default.

Syntax of the Configuration Files

Apache configuration files contain one directive per line. The back-slash `"\"` may be used as the last character on a line to indicate that the directive continues onto the next line. There must be no other characters or white space between the back-slash and the end of the line.

Directives in the configuration files are case-insensitive, but arguments to directives are often case sensitive. Lines that begin with the hash character `"#"` are considered comments, and are ignored. Comments may **not** be included on a line after a configuration directive. Blank lines and white space occurring before a directive are ignored, so you may indent directives for clarity.

You can check your configuration files for syntax errors without starting the server by using `apachectl configtest` or the `-t` command line option.

Modules

Related Modules	Related Directives
MOD_SO	<IFMODULE> LOADMODULE

Apache is a modular server. This implies that only the most basic functionality is included in the core server. Extended features are available through modules (p. 660) which can be loaded into Apache. By default, a base (p. 298) set of modules is included in the server at compile-time. If the server is compiled to use dynamically loaded (p. 44) modules, then modules can be compiled separately and added at any time using the [LOADMODULE](#) directive. Otherwise, Apache must be recompiled to add or remove modules. Configuration directives may be included conditional on a presence of a particular module by enclosing them in an [<IFMODULE>](#) block.

To see which modules are currently compiled into the server, you can use the `-l` command line option.

Scope of Directives

Related Modules	Related Directives
	<DIRECTORY> <DIRECTORYMATCH> <FILES> <FILESMATCH> <LOCATION> <LOCATIONMATCH> <VIRTUALHOST>

Directives placed in the main configuration files apply to the entire server. If you wish to change the configuration for only a part of the server, you can scope your directives by placing them in [<DIRECTORY>](#), [<DIRECTORYMATCH>](#), [<FILES>](#), [<FILESMATCH>](#), [<LOCATION>](#), and [<LOCATIONMATCH>](#) sections. These sections limit the application of the directives which they enclose to particular filesystem locations or URLs. They can also be nested, allowing for very fine grained configuration.

Apache has the capability to serve many different websites simultaneously. This is called Virtual Hosting (p. 110). Directives can also be scoped by placing them inside [<VIRTUALHOST>](#) sections, so that they will only apply to requests for a particular website.

Although most directives can be placed in any of these sections, some directives do not make sense in some contexts. For example, directives controlling process creation can only be placed in the main server context. To find which directives can be placed in which sections, check the Context (p. 299) of the directive. For further information, we provide details on How Directory, Location and Files sections work (p. 21).

.htaccess Files

Related Modules	Related Directives
	ACCESSFILENAME ALLOWOVERRIDE

Apache allows for decentralized management of configuration via special files placed inside the web tree. The special files are usually called `.htaccess`, but any name can be specified in the [ACCESSFILENAME](#) directive. Directives placed in `.htaccess` files apply to the directory where you place the file, and all sub-directories. The `.htaccess` files follow the same syntax as the main configuration files. Since `.htaccess` files are read on every request, changes made in these files take immediate effect.

To find which directives can be placed in `.htaccess` files, check the Context (p. 299) of the directive. The server administrator further controls what directives may be placed in `.htaccess` files by configuring the [ALLOWOVERRIDE](#) directive in the main configuration files.

For more information on `.htaccess` files, see the `.htaccess` tutorial (p. 197).

2.5 Configuration Sections

Directives in the configuration files (p. 19) may apply to the entire server, or they may be restricted to apply only to particular directories, files, hosts, or URLs. This document describes how to use configuration section containers or `.htaccess` files to change the scope of other configuration directives.

Types of Configuration Section Containers

Related Modules	Related Directives
CORE	<DIRECTORY>
MOD_PROXY	<DIRECTORYMATCH>
	<FILES>
	<FILESMATCH>
	<IFDEFINE>
	<IFMODULE>
	<LOCATION>
	<LOCATIONMATCH>
	<PROXY>
	<PROXYMATCH>
	<VIRTUALHOST>

There are two basic types of containers. Most containers are evaluated for each request. The enclosed directives are applied only for those requests that match the containers. The [<IFDEFINE>](#) and [<IFMODULE>](#) containers, on the other hand, are evaluated only at server startup and restart. If their conditions are true at startup, then the enclosed directives will apply to all requests. If the conditions are not true, the enclosed directives will be ignored.

The [<IFDEFINE>](#) directive encloses directives that will only be applied if an appropriate parameter is defined on the `httpd` command line. For example, with the following configuration, all requests will be redirected to another site only if the server is started using `httpd -DClosedForNow`:

```
<IfDefine ClosedForNow>
Redirect / http://otherserver.example.com/
</IfDefine>
```

The [<IFMODULE>](#) directive is very similar, except it encloses directives that will only be applied if a particular module is available in the server. The module must either be statically compiled in the server, or it must be dynamically compiled and its [LOADMODULE](#) line must be earlier in the configuration file. This directive should only be used if you need your configuration file to work whether or not certain modules are installed. It should not be used to enclose directives that you want to work all the time, because it can suppress useful error messages about missing modules.

In the following example, the [MIMEMAGICFILES](#) directive will be applied only if [MOD_MIME_MAGIC](#) is available.

```
<IfModule mod_mime_magic.c>
MimeMagicFile conf/magic
</IfModule>
```

Both [<IFDEFINE>](#) and [<IFMODULE>](#) can apply negative conditions by preceding their test with `!`. Also, these sections can be nested to achieve more complex restrictions.

Filesystem and Webpace

The most commonly used configuration section containers are the ones that change the configuration of particular places in the filesystem or webpace. First, it is important to understand the difference between the two. The filesystem is the view of your disks as seen by your operating system. For example, in a default install, Apache resides at `/usr/local/apache2` in the Unix filesystem or `"c:/Program Files/Apache Group/Apache2"` in the Windows filesystem. (Note that forward slashes should always be used as the path separator in Apache, even for Windows.) In contrast, the webpace is the view of your site as delivered by the web server and seen by the client. So the path `/dir/` in the webpace corresponds to the path `/usr/local/apache2/htdocs/dir/` in the filesystem of a default Apache install on Unix. The webpace need not map directly to the filesystem, since webpages may be generated dynamically from databases or other locations.

Filesystem Containers

The `<DIRECTORY>` and `<FILES>` directives, along with their regex counterparts, apply directives to parts of the filesystem. Directives enclosed in a `<DIRECTORY>` section apply to the named filesystem directory and all subdirectories of that directory. The same effect can be obtained using `.htaccess` files (p. 197). For example, in the following configuration, directory indexes will be enabled for the `/var/web/dir1` directory and all subdirectories.

```
<Directory /var/web/dir1>
Options +Indexes
</Directory>
```

Directives enclosed in a `<FILES>` section apply to any file with the specified name, regardless of what directory it lies in. So for example, the following configuration directives will, when placed in the main section of the configuration file, deny access to any file named `private.html` regardless of where it is found.

```
<Files private.html>
Order allow,deny
Deny from all
</Files>
```

To address files found in a particular part of the filesystem, the `<FILES>` and `<DIRECTORY>` sections can be combined. For example, the following configuration will deny access to `/var/web/dir1/private.html`, `/var/web/dir1/subdir2/private.html`, `/var/web/dir1/subdir3/private.html`, and any other instance of `private.html` found under the `/var/web/dir1/` directory.

```
<Directory /var/web/dir1>
<Files private.html>
Order allow,deny
Deny from all
</Files>
</Directory>
```

Webpace Containers

The `<LOCATION>` directive and its regex counterpart, on the other hand, change the configuration for content in the webpace. For example, the following configuration prevents access to any URL-path that begins in `/private`. In particular, it will apply to requests for

http://yoursite.example.com/private, http://yoursite.example.com/private123, and http://yoursite.example.com/private/dir/file.html as well as any other requests starting with the /private string.

```
<Location /private>
Order Allow,Deny
Deny from all
</Location>
```

The `<LOCATION>` directive need not have anything to do with the filesystem. For example, the following example shows how to map a particular URL to an internal Apache handler provided by `MOD_STATUS`. No file called `server-status` needs to exist in the filesystem.

```
<Location /server-status>
SetHandler server-status
</Location>
```

Wildcards and Regular Expressions

The `<DIRECTORY>`, `<FILES>`, and `<LOCATION>` directives can each use shell-style wildcard characters as in `fnmatch` from the C standard library. The character `"*"` matches any sequence of characters, `"?"` matches any single character, and `"[seq]"` matches any character in `seq`. The `"/"` character will not be matched by any wildcard; it must be specified explicitly.

If even more flexible matching is required, each container has a regular-expression (regex) counterpart `<DIRECTORYMATCH>`, `<FILESMATCH>`, and `<LOCATIONMATCH>` that allow perl-compatible regular expressions (p. 656) to be used in choosing the matches. But see the section below on configuration merging to find out how using regex sections will change how directives are applied.

A non-regex wildcard section that changes the configuration of all user directories could look as follows:

```
<Directory /home/*/public.html>
Options Indexes
</Directory>
```

Using regex sections, we can deny access to many types of image files at once:

```
<FilesMatch \.(?:gif|jpe?g|png)$>
Order allow,deny
Deny from all
</FilesMatch>
```

What to use When

Choosing between filesystem containers and web space containers is actually quite easy. When applying directives to objects that reside in the filesystem always use `<DIRECTORY>` or `<FILES>`. When applying directives to objects that do not reside in the filesystem (such as a webpage generated from a database), use `<LOCATION>`.

It is important to never use `<LOCATION>` when trying to restrict access to objects in the filesystem. This is because many different web space locations (URLs) could map to the same filesystem location, allowing your restrictions to be circumvented. For example, consider the following configuration:

```

<Location /dir/>
Order allow,deny
Deny from all
</Location>

```

This works fine if the request is for `http://yoursite.example.com/dir/`. But what if you are on a case-insensitive filesystem? Then your restriction could be easily circumvented by requesting `http://yoursite.example.com/DIR/`. The `<DIRECTORY>` directive, in contrast, will apply to any content served from that location, regardless of how it is called. (An exception is filesystem links. The same directory can be placed in more than one part of the filesystem using symbolic links. The `<DIRECTORY>` directive will follow the symbolic link without resetting the pathname. Therefore, for the highest level of security, symbolic links should be disabled with the appropriate `OPTIONS` directive.)

If you are, perhaps, thinking that none of this applies to you because you use a case-sensitive filesystem, remember that there are many other ways to map multiple webspace locations to the same filesystem location. Therefore you should always use the filesystem containers when you can. There is, however, one exception to this rule. Putting configuration restrictions in a `<Location />` section is perfectly safe because this section will apply to all requests regardless of the specific URL.

Virtual Hosts

The `<VIRTUALHOST>` container encloses directives that apply to specific hosts. This is useful when serving multiple hosts from the same machine with a different configuration for each. For more information, see the Virtual Host Documentation (p. 110).

Proxy

The `<PROXY>` and `<PROXYMATCH>` containers apply enclosed configuration directives only to sites accessed through `MOD_PROXY`'s proxy server that match the specified URL. For example, the following configuration will prevent the proxy server from being used to access the `cnn.com` website.

```

<Proxy http://cnn.com/*>
Order allow,deny
Deny from all
</Proxy>

```

What Directives are Allowed?

To find out what directives are allowed in what types of configuration sections, check the Context (p. 299) of the directive. Everything that is allowed in `<DIRECTORY>` sections is also syntactically allowed in `<DIRECTORYMATCH>`, `<FILES>`, `<FILESMATCH>`, `<LOCATION>`, `<LOCATIONMATCH>`, `<PROXY>`, and `<PROXYMATCH>` sections. There are some exceptions, however:

- The `ALLOWOVERRIDE` directive works only in `<DIRECTORY>` sections.
- The `FollowSymLinks` and `SymLinksIfOwnerMatch` `OPTIONS` work only in `<DIRECTORY>` sections or `.htaccess` files.
- The `OPTIONS` directive cannot be used in `<FILES>` and `<FILESMATCH>` sections.

How the sections are merged

The configuration sections are applied in a very particular order. Since this can have important effects on how configuration directives are interpreted, it is important to understand how this works.

The order of merging is:

1. `<DIRECTORY>` (except regular expressions) and `.htaccess` done simultaneously (with `.htaccess`, if allowed, overriding `<DIRECTORY>`)
2. `<DIRECTORYMATCH>` (and `<Directory ~>`)
3. `<FILES>` and `<FILESMATCH>` done simultaneously
4. `<LOCATION>` and `<LOCATIONMATCH>` done simultaneously

Apart from `<DIRECTORY>`, each group is processed in the order that they appear in the configuration files. `<DIRECTORY>` (group 1 above) is processed in the order shortest directory component to longest. So for example, `<Directory /var/web/dir>` will be processed before `<Directory /var/web/dir/subdir>`. If multiple `<DIRECTORY>` sections apply to the same directory they are processed in the configuration file order. Configurations included via the `INCLUDE` directive will be treated as if they were inside the including file at the location of the `INCLUDE` directive.

Sections inside `<VIRTUALHOST>` sections are applied *after* the corresponding sections outside the virtual host definition. This allows virtual hosts to override the main server configuration.

Later sections override earlier ones.

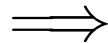

Technical Note

There is actually a `<Location>/<LocationMatch>` sequence performed just before the name translation phase (where `Aliases` and `DocumentRoots` are used to map URLs to filenames). The results of this sequence are completely thrown away after the translation has completed.

Some Examples

Below is an artificial example to show the order of merging. Assuming they all apply to the request, the directives in this example will be applied in the order A > B > C > D > E.

```

<Location />
E
</Location>
<Files f.html>
D
</Files>
<VirtualHost *>
<Directory /a/b>
B
</Directory>
</VirtualHost>
<DirectoryMatch "^.*b$">
C
</DirectoryMatch>
<Directory /a/b>
A
</Directory>

```

For a more concrete example, consider the following. Regardless of any access restrictions placed in `<DIRECTORY>` sections, the `<LOCATION>` section will be evaluated last and will allow unrestricted access to the server. In other words, order of merging is important, so be careful!

```
<Location />
Order deny,allow
Allow from all
</Location>

# Woops! This <Directory> section will have no effect
<Directory />
Order allow,deny
Allow from all
Deny from badguy.example.com
</Directory>
```

2.6 Server-Wide Configuration

This document explains some of the directives provided by the [CORE](#) server which are used to configure the basic operations of the server.

Server Identification

Related Modules	Related Directives
	SERVERNAME SERVERADMIN SERVERSIGNATURE SERVERTOKENS USECANONICALNAME

The [SERVERADMIN](#) and [SERVERTOKENS](#) directives control what information about the server will be presented in server-generated documents such as error messages. The [SERVERTOKENS](#) directive sets the value of the Server HTTP response header field.

The [SERVERNAME](#) and [USECANONICALNAME](#) directives are used by the server to determine how to construct self-referential URLs. For example, when a client requests a directory, but does not include the trailing slash in the directory name, Apache must redirect the client to the full name including the trailing slash so that the client will correctly resolve relative references in the document.

File Locations

Related Modules	Related Directives
	COREDUMPDIRECTORY DOCUMENTROOT ERRORLOG LOCKFILE PIDFILE SCOREBOARDFILE SERVERROOT

These directives control the locations of the various files that Apache needs for proper operation. When the pathname used does not begin with a slash (/), the files are located relative to the [SERVERROOT](#). Be careful about locating files in paths which are writable by non-root users. See the security tips (p. 40) documentation for more details.

Limiting Resource Usage

Related Modules	Related Directives
	LIMITREQUESTBODY LIMITREQUESTFIELDS LIMITREQUESTFIELDSIZE LIMITREQUESTLINE RLIMITCPU RLIMITMEM RLIMITNPROC THREADSTACKSIZE

The `LIMITREQUEST`* directives are used to place limits on the amount of resources Apache will use in reading requests from clients. By limiting these values, some kinds of denial of service attacks can be mitigated.

The `RLIMIT`* directives are used to limit the amount of resources which can be used by processes forked off from the Apache children. In particular, this will control resources used by CGI scripts and SSI exec commands.

The `THREADSTACKSIZE` directive is used only on Netware to control the stack size.

2.7 Log Files

In order to effectively manage a web server, it is necessary to get feedback about the activity and performance of the server as well as any problems that may be occurring. The Apache HTTP Server provides very comprehensive and flexible logging capabilities. This document describes how to configure its logging capabilities, and how to understand what the logs contain.

Security Warning

Anyone who can write to the directory where Apache is writing a log file can almost certainly gain access to the uid that the server is started as, which is normally root. Do *NOT* give people write access to the directory the logs are stored in without being aware of the consequences; see the security tips (p. 40) document for details.

In addition, log files may contain information supplied directly by the client, without escaping. Therefore, it is possible for malicious clients to insert control-characters in the log files, so care must be taken in dealing with raw logs.

Error Log

Related Modules	Related Directives
	ERRORLOG LOGLEVEL

The server error log, whose name and location is set by the [ERRORLOG](#) directive, is the most important log file. This is the place where Apache httpd will send diagnostic information and record any errors that it encounters in processing requests. It is the first place to look when a problem occurs with starting the server or with the operation of the server, since it will often contain details of what went wrong and how to fix it.

The error log is usually written to a file (typically `error_log` on Unix systems and `error.log` on Windows and OS/2). On Unix systems it is also possible to have the server send errors to `syslog` or pipe them to a program.

The format of the error log is relatively free-form and descriptive. But there is certain information that is contained in most error log entries. For example, here is a typical message.

```
[Wed Oct 11 14:32:52 2000] [error] [client 127.0.0.1] client denied
by server configuration: /export/home/live/ap/htdocs/test
```

The first item in the log entry is the date and time of the message. The second item lists the severity of the error being reported. The [LOGLEVEL](#) directive is used to control the types of errors that are sent to the error log by restricting the severity level. The third item gives the IP address of the client that generated the error. Beyond that is the message itself, which in this case indicates that the server has been configured to deny the client access. The server reports the file-system path (as opposed to the web path) of the requested document.

A very wide variety of different messages can appear in the error log. Most look similar to the example above. The error log will also contain debugging output from CGI scripts. Any information written to `stderr` by a CGI script will be copied directly to the error log.

It is not possible to customize the error log by adding or removing information. However, error log entries dealing with particular requests have corresponding entries in the access log. For example, the above example entry corresponds to an access log entry with status code 403. Since it is possible to customize the access log, you can obtain more information about error conditions using that log file.

During testing, it is often useful to continuously monitor the error log for any problems. On Unix systems, you can accomplish this using:

```
tail -f error_log
```

Access Log

Related Modules

[MOD_LOG_CONFIG](#)
[MOD_SETENVIF](#)

Related Directives

[CUSTOMLOG](#)
[LOGFORMAT](#)
[SETENVIF](#)

The server access log records all requests processed by the server. The location and content of the access log are controlled by the [CUSTOMLOG](#) directive. The [LOGFORMAT](#) directive can be used to simplify the selection of the contents of the logs. This section describes how to configure the server to record information in the access log.

Of course, storing the information in the access log is only the start of log management. The next step is to analyze this information to produce useful statistics. Log analysis in general is beyond the scope of this document, and not really part of the job of the web server itself. For more information about this topic, and for applications which perform log analysis, check the Open Directory⁹ or Yahoo¹⁰.

Various versions of Apache httpd have used other modules and directives to control access logging, including `mod_log_referer`, `mod_log_agent`, and the `TransferLog` directive. The [CUSTOMLOG](#) directive now subsumes the functionality of all the older directives.

The format of the access log is highly configurable. The format is specified using a format string that looks much like a C-style `printf(1)` format string. Some examples are presented in the next sections. For a complete list of the possible contents of the format string, see the [MOD_LOG_CONFIG](#) format strings (p. 471).

Common Log Format

A typical configuration for the access log might look as follows.

```
LogFormat "%h %l %u %t \"%r\" %>s %b" common
CustomLog logs/access_log common
```

This defines the *nickname* `common` and associates it with a particular log format string. The format string consists of percent directives, each of which tell the server to log a particular piece of information. Literal characters may also be placed in the format string and will be copied directly into the log output. The quote character (") must be escaped by placing a back-slash before it to prevent it from being interpreted as the end of the format string. The format string may also contain the special control characters `"\n"` for new-line and `"\t"` for tab.

The [CUSTOMLOG](#) directive sets up a new log file using the defined *nickname*. The filename for the access log is relative to the [SERVERROOT](#) unless it begins with a slash.

The above configuration will write log entries in a format known as the Common Log Format (CLF). This standard format can be produced by many different web servers and read by many log analysis programs. The log file entries produced in CLF will look something like this:

```
127.0.0.1 - frank [10/Oct/2000:13:55:36 -0700] "GET /apache_pb.gif
HTTP/1.0" 200 2326
```

⁹http://dmoz.org/Computers/Software/Internet/Site_Management/Log_analysis/

¹⁰http://dir.yahoo.com/Computers_and_Internet/Software/Internet/World_Wide_Web/Servers/Log_Analysis_Tools/

Each part of this log entry is described below.

127.0.0.1 (%h) This is the IP address of the client (remote host) which made the request to the server. If `HOSTNAMELOOKUPS` is set to `On`, then the server will try to determine the hostname and log it in place of the IP address. However, this configuration is not recommended since it can significantly slow the server. Instead, it is best to use a log post-processor such as `logresolve` to determine the hostnames. The IP address reported here is not necessarily the address of the machine at which the user is sitting. If a proxy server exists between the user and the server, this address will be the address of the proxy, rather than the originating machine.

– **(%l)** The "hyphen" in the output indicates that the requested piece of information is not available. In this case, the information that is not available is the RFC 1413 identity of the client determined by `identd` on the client's machine. This information is highly unreliable and should almost never be used except on tightly controlled internal networks. Apache `httpd` will not even attempt to determine this information unless `IDENTITYCHECK` is set to `On`.

frank (%u) This is the userid of the person requesting the document as determined by HTTP authentication. The same value is typically provided to CGI scripts in the `REMOTE_USER` environment variable. If the status code for the request (see below) is 401, then this value should not be trusted because the user is not yet authenticated. If the document is not password protected, this part will be "-" just like the previous one.

[10/Oct/2000:13:55:36 -0700] (%t) The time that the request was received. The format is:

```
[day/month/year:hour:minute:second zone]
day = 2*digit
month = 3*letter
year = 4*digit
hour = 2*digit
minute = 2*digit
second = 2*digit
zone = ('+' | '-') 4*digit
```

It is possible to have the time displayed in another format by specifying `%{format}t` in the log format string, where `format` is as in `strftime(3)` from the C standard library.

"GET /apache_pb.gif HTTP/1.0" (%r) The request line from the client is given in double quotes. The request line contains a great deal of useful information. First, the method used by the client is `GET`. Second, the client requested the resource `/apache_pb.gif`, and third, the client used the protocol `HTTP/1.0`. It is also possible to log one or more parts of the request line independently. For example, the format string `"%m %U%q %H"` will log the method, path, query-string, and protocol, resulting in exactly the same output as `"%r"`.

200 (%>s) This is the status code that the server sends back to the client. This information is very valuable, because it reveals whether the request resulted in a successful response (codes beginning in 2), a redirection (codes beginning in 3), an error caused by the client (codes beginning in 4), or an error in the server (codes beginning in 5). The full list of possible status codes can be found in the HTTP specification¹¹ (RFC2616 section 10).

2326 (%b) The last part indicates the size of the object returned to the client, not including the response headers. If no content was returned to the client, this value will be "-". To log "0" for no content, use `%B` instead.

Combined Log Format

Another commonly used format string is called the Combined Log Format. It can be used as follows.

```
LogFormat "%h %l %u %t \"%r\" %>s %b \"%{Referer}i\"
\"{%User-agent}i\" combined
CustomLog log/access_log combined
```

¹¹<http://www.w3.org/Protocols/rfc2616/rfc2616.txt>

This format is exactly the same as the Common Log Format, with the addition of two more fields. Each of the additional fields uses the percent-directive `%{header}i`, where *header* can be any HTTP request header. The access log under this format will look like:

```
127.0.0.1 - frank [10/Oct/2000:13:55:36 -0700] "GET /apache_pb.gif
HTTP/1.0" 200 2326 "http://www.example.com/start.html" "Mozilla/4.08
[en] (Win98; I ;Nav) "
```

The additional fields are:

`"http://www.example.com/start.html" (\ "%{Referer}i \")` The "Referer" (sic) HTTP request header. This gives the site that the client reports having been referred from. (This should be the page that links to or includes `/apache_pb.gif`).

`"Mozilla/4.08 [en] (Win98; I ;Nav) (\ "%{User-agent}i \")` The User-Agent HTTP request header. This is the identifying information that the client browser reports about itself.

Multiple Access Logs

Multiple access logs can be created simply by specifying multiple `CUSTOMLOG` directives in the configuration file. For example, the following directives will create three access logs. The first contains the basic CLF information, while the second and third contain referer and browser information. The last two `CUSTOMLOG` lines show how to mimic the effects of the `RefererLog` and `AgentLog` directives.

```
LogFormat "%h %l %u %t \"%r\" %>s %b" common
CustomLog logs/access_log common
CustomLog logs/referer_log "%{Referer}i -> %U"
CustomLog logs/agent_log "%{User-agent}i"
```

This example also shows that it is not necessary to define a nickname with the `LOGFORMAT` directive. Instead, the log format can be specified directly in the `CUSTOMLOG` directive.

Conditional Logs

There are times when it is convenient to exclude certain entries from the access logs based on characteristics of the client request. This is easily accomplished with the help of environment variables (p. 60). First, an environment variable must be set to indicate that the request meets certain conditions. This is usually accomplished with `SETENVIF`. Then the `env=` clause of the `CUSTOMLOG` directive is used to include or exclude requests where the environment variable is set. Some examples:

```
# Mark requests from the loop-back interface
SetEnvIf Remote_Addr "127\.0\.0\.1" dontlog
# Mark requests for the robots.txt file
SetEnvIf Request_URI "^/robots\.txt$" dontlog
# Log what remains
CustomLog logs/access_log common env=!dontlog
```

As another example, consider logging requests from english-speakers to one log file, and non-english speakers to a different log file.

```
SetEnvIf Accept-Language "en" english
CustomLog logs/english.log common env=english
CustomLog logs/non_english.log common env!=english
```

Although we have just shown that conditional logging is very powerful and flexible, it is not the only way to control the contents of the logs. Log files are more useful when they contain a complete record of server activity. It is often easier to simply post-process the log files to remove requests that you do not want to consider.

Log Rotation

On even a moderately busy server, the quantity of information stored in the log files is very large. The access log file typically grows 1 MB or more per 10,000 requests. It will consequently be necessary to periodically rotate the log files by moving or deleting the existing logs. This cannot be done while the server is running, because Apache will continue writing to the old log file as long as it holds the file open. Instead, the server must be restarted (p. 16) after the log files are moved or deleted so that it will open new log files.

By using a *graceful* restart, the server can be instructed to open new log files without losing any existing or pending connections from clients. However, in order to accomplish this, the server must continue to write to the old log files while it finishes serving old requests. It is therefore necessary to wait for some time after the restart before doing any processing on the log files. A typical scenario that simply rotates the logs and compresses the old logs to save space is:

```
mv access.log access_log.old
mv error.log error_log.old
apachectl graceful
sleep 600
gzip access_log.old error_log.old
```

Another way to perform log rotation is using piped logs as discussed in the next section.

Piped Logs

Apache httpd is capable of writing error and access log files through a pipe to another process, rather than directly to a file. This capability dramatically increases the flexibility of logging, without adding code to the main server. In order to write logs to a pipe, simply replace the filename with the pipe character "|", followed by the name of the executable which should accept log entries on its standard input. Apache will start the piped-log process when the server starts, and will restart it if it crashes while the server is running. (This last feature is why we can refer to this technique as "reliable piped logging".)

Piped log processes are spawned by the parent Apache httpd process, and inherit the userid of that process. This means that piped log programs usually run as root. It is therefore very important to keep the programs simple and secure.

One important use of piped logs is to allow log rotation without having to restart the server. The Apache HTTP Server includes a simple program called `rotatelog`s for this purpose. For example, to rotate the logs every 24 hours, you can use:

```
CustomLog "|/usr/local/apache/bin/rotatelog /var/log/access_log
86400" common
```

Notice that quotes are used to enclose the entire command that will be called for the pipe. Although these examples are for the access log, the same technique can be used for the error log.

A similar but much more flexible log rotation program called `cronolog`¹² is available at an external site.

As with conditional logging, piped logs are a very powerful tool, but they should not be used where a simpler solution like off-line post-processing is available.

Virtual Hosts

When running a server with many virtual hosts (p. 110), there are several options for dealing with log files. First, it is possible to use logs exactly as in a single-host server. Simply by placing the logging directives outside the `<VIRTUALHOST>` sections in the main server context, it is possible to log all requests in the same access log and error log. This technique does not allow for easy collection of statistics on individual virtual hosts.

If `CUSTOMLOG` or `ERRORLOG` directives are placed inside a `<VIRTUALHOST>` section, all requests or errors for that virtual host will be logged only to the specified file. Any virtual host which does not have logging directives will still have its requests sent to the main server logs. This technique is very useful for a small number of virtual hosts, but if the number of hosts is very large, it can be complicated to manage. In addition, it can often create problems with insufficient file descriptors (p. 134).

For the access log, there is a very good compromise. By adding information on the virtual host to the log format string, it is possible to log all hosts to the same log, and later split the log into individual files. For example, consider the following directives.

```
LogFormat "%v %l %u %t \"%r\" %>s %b" comonvhost
CustomLog logs/access_log comonvhost
```

The `%v` is used to log the name of the virtual host that is serving the request. Then a program like `split-logfile` (p. 269) can be used to post-process the access log in order to split it into one file per virtual host.

Other Log Files

Related Modules	Related Directives
<code>MOD_CGI</code>	<code>PIDFILE</code>
<code>MOD_REWRITE</code>	<code>REWRITELOG</code>
	<code>REWRITELOGLEVEL</code>
	<code>SCRIPTLOG</code>
	<code>SCRIPTLOGBUFFER</code>
	<code>SCRIPTLOGLENGTH</code>

PID File

On startup, Apache `httpd` saves the process id of the parent `httpd` process to the file `logs/httpd.pid`. This filename can be changed with the `PIDFILE` directive. The process-id is for use by the administrator in restarting and terminating the daemon by sending signals to the parent process; on Windows, use the `-k` command line option instead. For more information see the Stopping and Restarting (p. 16) page.

¹²<http://www.cronolog.org/>

Script Log

In order to aid in debugging, the [SCRIPTLOG](#) directive allows you to record the input to and output from CGI scripts. This should only be used in testing - not for live servers. More information is available in the [mod_cgi](#) (p. 399) documentation.

Rewrite Log

When using the powerful and complex features of [mod_rewrite](#) (p. 521) , it is almost always necessary to use the [REWRITELOG](#) to help in debugging. This log file produces a detailed analysis of how the rewriting engine transforms requests. The level of detail is controlled by the [REWRITELOGLEVEL](#) directive.

2.8 Mapping URLs to Filesystem Locations

This document explains how Apache uses the URL of a request to determine the filesystem location from which to serve a file.

Related Modules and Directives

Related Modules	Related Directives
MOD_ALIAS	ALIAS
MOD_PROXY	ALIASMATCH
MOD_REWRITE	CHECKSPELLING
MOD_USERDIR	DOCUMENTROOT
MOD_SPELING	ERRORDOCUMENT
MOD_VHOST_ALIAS	OPTIONS
	PROXYPASS
	PROXYPASSREVERSE
	REDIRECT
	REDIRECTMATCH
	REWRITECOND
	REWRITEMATCH
	SCRIPTALIAS
	SCRIPTALIASMATCH
	USERDIR

DocumentRoot

In deciding what file to serve for a given request, Apache's default behavior is to take the URL-Path for the request (the part of the URL following the hostname and port) and add it to the end of the [DOCUMENTROOT](#) specified in your configuration files. Therefore, the files and directories underneath the [DOCUMENTROOT](#) make up the basic document tree which will be visible from the web.

Apache is also capable of Virtual Hosting (p. 110) , where the server receives requests for more than one host. In this case, a different [DOCUMENTROOT](#) can be specified for each virtual host, or alternatively, the directives provided by the module [MOD_VHOST_ALIAS](#) can be used to dynamically determine the appropriate place from which to serve content based on the requested IP address or hostname.

Files Outside the DocumentRoot

There are frequently circumstances where it is necessary to allow web access to parts of the filesystem that are not strictly underneath the [DOCUMENTROOT](#). Apache offers several different ways to accomplish this. On Unix systems, symbolic links can bring other parts of the filesystem under the [DOCUMENTROOT](#). For security reasons, Apache will follow symbolic links only if the [OPTIONS](#) setting for the relevant directory includes `FollowSymLinks` or `SymLinksIfOwnerMatch`.

Alternatively, the [ALIAS](#) directive will map any part of the filesystem into the web space. For example, with

```
Alias /docs /var/web
```

the URL `http://www.example.com/docs/dir/file.html` will be served from `/var/web/dir/file.html`. The [SCRIPTALIAS](#) directive works the same way, with the additional effect that all content located at the target path is treated as CGI scripts.

For situations where you require additional flexibility, you can use the [ALIASMATCH](#) and [SCRIPTALIASMATCH](#) directives to do powerful regular-expression based matching and substitution. For example,

```
ScriptAliasMatch ^/~([a-zA-Z0-9]+)/cgi-bin/(.+) /home/$1/cgi-bin/$2
```

will map a request to `http://example.com/~user/cgi-bin/script.cgi` to the path `/home/user/cgi-bin/script.cgi` and will treat the resulting file as a CGI script.

User Directories

Traditionally on Unix systems, the home directory of a particular *user* can be referred to as `~user/`. The module [MOD_USERDIR](#) extends this idea to the web by allowing files under each user's home directory to be accessed using URLs such as the following.

```
http://www.example.com/~user/file.html
```

For security reasons, it is inappropriate to give direct access to a user's home directory from the web. Therefore, the [USERDIR](#) directive specifies a directory underneath the user's home directory where web files are located. Using the default setting of `Userdir public.html`, the above URL maps to a file at a directory like `/home/user/public.html/file.html` where `/home/user/` is the user's home directory as specified in `/etc/passwd`.

There are also several other forms of the `Userdir` directive which you can use on systems where `/etc/passwd` does not contain the location of the home directory.

Some people find the "~" symbol (which is often encoded on the web as `%7e`) to be awkward and prefer to use an alternate string to represent user directories. This functionality is not supported by `mod_userdir`. However, if users' home directories are structured in a regular way, then it is possible to use the [ALIASMATCH](#) directive to achieve the desired effect. For example, to make `http://www.example.com/upages/user/file.html` map to `/home/user/public.html/file.html`, use the following `AliasMatch` directive:

```
AliasMatch ^/upages/([a-zA-Z0-9]+)/?(.*) /home/$1/public.html/$2
```

URL Redirection

The configuration directives discussed in the above sections tell Apache to get content from a specific place in the filesystem and return it to the client. Sometimes, it is desirable instead to inform the client that the requested content is located at a different URL, and instruct the client to make a new request with the new URL. This is called *redirection* and is implemented by the [REDIRECT](#) directive. For example, if the contents of the directory `/foo/` under the [DOCUMENTROOT](#) are moved to the new directory `/bar/`, you can instruct clients to request the content at the new location as follows:

```
Redirect permanent /foo/ http://www.example.com/bar/
```

This will redirect any URL-Path starting in `/foo/` to the same URL path on the `www.example.com` server with `/bar/` substituted for `/foo/`. You can redirect clients to any server, not only the origin server.

Apache also provides a [REDIRECTMATCH](#) directive for more complicated rewriting problems. For example, to redirect requests for the site home page to a different site, but leave all other requests alone, use the following configuration:

```
RedirectMatch permanent ^/$ http://www.example.com/startpage.html
```

Alternatively, to temporarily redirect all pages on one site to a particular page on another site, use the following:

```
RedirectMatch temp .* http://othersite.example.com/startpage.html
```

Reverse Proxy

Apache also allows you to bring remote documents into the URL space of the local server. This technique is called *reverse proxying* because the web server acts like a proxy server by fetching the documents from a remote server and returning them to the client. It is different from normal proxying because, to the client, it appears the documents originate at the reverse proxy server.

In the following example, when clients request documents under the `/foo/` directory, the server fetches those documents from the `/bar/` directory on `internal.example.com` and returns them to the client as if they were from the local server.

```
ProxyPass /foo/ http://internal.example.com/bar/
ProxyPassReverse /foo/ http://internal.example.com/bar/
```

The `PROXYPASS` configures the server to fetch the appropriate documents, while the `PROXYPASSREVERSE` directive rewrites redirects originating at `internal.example.com` so that they target the appropriate directory on the local server. It is important to note, however, that links inside the documents will not be rewritten. So any absolute links on `internal.example.com` will result in the client breaking out of the proxy server and requesting directly from `internal.example.com`.

Rewriting Engine

When even more powerful substitution is required, the rewriting engine provided by `MOD_REWRITE` can be useful. The directives provided by this module use characteristics of the request such as browser type or source IP address in deciding from where to serve content. In addition, `mod_rewrite` can use external database files or programs to determine how to handle a request. The rewriting engine is capable of performing all three types of mappings discussed above: internal redirects (aliases), external redirects, and proxying. Many practical examples employing `mod_rewrite` are discussed in the URL Rewriting Guide (p. 85).

File Not Found

Inevitably, URLs will be requested for which no matching file can be found in the filesystem. This can happen for several reasons. In some cases, it can be a result of moving documents from one location to another. In this case, it is best to use URL redirection to inform clients of the new location of the resource. In this way, you can assure that old bookmarks and links will continue to work, even though the resource is at a new location.

Another common cause of "File Not Found" errors is accidental mistyping of URLs, either directly in the browser, or in HTML links. Apache provides the module `MOD_SPELLING` (sic) to help with this problem. When this module is activated, it will intercept "File Not Found" errors and look for a resource with a similar filename. If one such file is found, `mod_spelling` will send an HTTP redirect to the client informing it of the correct location. If several "close" files are found, a list of available alternatives will be presented to the client.

An especially useful feature of `mod_spelling`, is that it will compare filenames without respect to case. This can help systems where users are unaware of the case-sensitive nature of URLs and the unix filesystem. But using `mod_spelling`

for anything more than the occasional URL correction can place additional load on the server, since each "incorrect" request is followed by a URL redirection and a new request from the client.

If all attempts to locate the content fail, Apache returns an error page with HTTP status code 404 (file not found). The appearance of this page is controlled with the [ERRORDOCUMENT](#) directive and can be customized in a flexible manner as discussed in the Custom error responses (p. [54](#)) and International Server Error Responses (p. [273](#)) documents.

2.9 Security Tips

Some hints and tips on security issues in setting up a web server. Some of the suggestions will be general, others specific to Apache.

Keep up to Date

The Apache HTTP Server has a good record for security and a developer community highly concerned about security issues. But it is inevitable that some problems – small or large – will be discovered in software after it is released. For this reason, it is crucial to keep aware of updates to the software. If you have obtained your version of the HTTP Server directly from Apache, we highly recommend you subscribe to the Apache HTTP Server Announcements List¹³ where you can keep informed of new releases and security updates. Similar services are available from most third-party distributors of Apache software.

Of course, most times that a web server is compromised, it is not because of problems in the HTTP Server code. Rather, it comes from problems in add-on code, CGI scripts, or the underlying Operating System. You must therefore stay aware of problems and updates with all the software on your system.

Permissions on ServerRoot Directories

In typical operation, Apache is started by the root user, and it switches to the user defined by the `USER` directive to serve hits. As is the case with any command that root executes, you must take care that it is protected from modification by non-root users. Not only must the files themselves be writeable only by root, but so must the directories, and parents of all directories. For example, if you choose to place `ServerRoot` in `/usr/local/apache` then it is suggested that you create that directory as root, with commands like these:

```
mkdir /usr/local/apache
cd /usr/local/apache
mkdir bin conf logs
chown 0 . bin conf logs
chgrp 0 . bin conf logs
chmod 755 . bin conf logs
```

It is assumed that `/`, `/usr`, and `/usr/local` are only modifiable by root. When you install the `httpd` executable, you should ensure that it is similarly protected:

```
cp httpd /usr/local/apache/bin
chown 0 /usr/local/apache/bin/httpd
chgrp 0 /usr/local/apache/bin/httpd
chmod 511 /usr/local/apache/bin/httpd
```

You can create an `htdocs` subdirectory which is modifiable by other users – since root never executes any files out of there, and shouldn't be creating files in there.

If you allow non-root users to modify any files that root either executes or writes on then you open your system to root compromises. For example, someone could replace the `httpd` binary so that the next time you start it, it will execute some arbitrary code. If the `logs` directory is writeable (by a non-root user), someone could replace a log file with a symlink to some other system file, and then root might overwrite that file with arbitrary data. If the log files themselves are writeable (by a non-root user), then someone may be able to overwrite the log itself with bogus data.

¹³<http://httpd.apache.org/lists.html#http-announce>

Server Side Includes

Server Side Includes (SSI) present a server administrator with several potential security risks.

The first risk is the increased load on the server. All SSI-enabled files have to be parsed by Apache, whether or not there are any SSI directives included within the files. While this load increase is minor, in a shared server environment it can become significant.

SSI files also pose the same risks that are associated with CGI scripts in general. Using the "exec cmd" element, SSI-enabled files can execute any CGI script or program under the permissions of the user and group Apache runs as, as configured in httpd.conf.

There are ways to enhance the security of SSI files while still taking advantage of the benefits they provide.

To isolate the damage a wayward SSI file can cause, a server administrator can enable suexec (p. 68) as described in the CGI in General section.

Enabling SSI for files with .html or .htm extensions can be dangerous. This is especially true in a shared, or high traffic, server environment. SSI-enabled files should have a separate extension, such as the conventional .shtml. This helps keep server load at a minimum and allows for easier management of risk.

Another solution is to disable the ability to run scripts and programs from SSI pages. To do this replace Includes with IncludesNOEXEC in the OPTIONS directive. Note that users may still use <#include virtual="..." -> to execute CGI scripts if these scripts are in directories designated by a SCRIPTALIAS directive.

CGI in General

First of all, you always have to remember that you must trust the writers of the CGI scripts/programs or your ability to spot potential security holes in CGI, whether they were deliberate or accidental. CGI scripts can run essentially arbitrary commands on your system with the permissions of the web server user and can therefore be extremely dangerous if they are not carefully checked.

All the CGI scripts will run as the same user, so they have potential to conflict (accidentally or deliberately) with other scripts e.g. User A hates User B, so he writes a script to trash User B's CGI database. One program which can be used to allow scripts to run as different users is suEXEC (p. 68) which is included with Apache as of 1.2 and is called from special hooks in the Apache server code. Another popular way of doing this is with CGIWrap¹⁴.

Non Script Aliased CGI

Allowing users to execute CGI scripts in any directory should only be considered if:

- You trust your users not to write scripts which will deliberately or accidentally expose your system to an attack.
- You consider security at your site to be so feeble in other areas, as to make one more potential hole irrelevant.
- You have no users, and nobody ever visits your server.

Script Aliased CGI

Limiting CGI to special directories gives the admin control over what goes into those directories. This is inevitably more secure than non script aliased CGI, but only if users with write access to the directories are trusted or the admin is willing to test each new CGI script/program for potential security holes.

Most sites choose this option over the non script aliased CGI approach.

¹⁴<http://cgiwrap.unixtools.org/>

Other sources of dynamic content

Embedded scripting options which run as part of the server itself, such as `mod_php`, `mod_perl`, `mod_tcl`, and `mod_python`, run under the identity of the server itself (see the `USER` directive), and therefore scripts executed by these engines potentially can access anything the server user can. Some scripting engines may provide restrictions, but it is better to be safe and assume not.

Protecting System Settings

To run a really tight ship, you'll want to stop users from setting up `.htaccess` files which can override security features you've configured. Here's one way to do it.

In the server configuration file, put

```
<Directory />
AllowOverride None
</Directory>
```

This prevents the use of `.htaccess` files in all directories apart from those specifically enabled.

Protect Server Files by Default

One aspect of Apache which is occasionally misunderstood is the feature of default access. That is, unless you take steps to change it, if the server can find its way to a file through normal URL mapping rules, it can serve it to clients.

For instance, consider the following example:

```
# cd /; ln -s / public.html
Accessing http://localhost/~root/
```

This would allow clients to walk through the entire filesystem. To work around this, add the following block to your server's configuration:

```
<Directory />
Order Deny,Allow
Deny from all
</Directory>
```

This will forbid default access to filesystem locations. Add appropriate `DIRECTORY` blocks to allow access only in those areas you wish. For example,

```
<Directory /usr/users/*/public.html>
Order Deny,Allow
Allow from all
</Directory>
<Directory /usr/local/httpd>
Order Deny,Allow
Allow from all
</Directory>
```

Pay particular attention to the interactions of **LOCATION** and **DIRECTORY** directives; for instance, even if `<Directory />` denies access, a `<Location />` directive might overturn it.

Also be wary of playing games with the **USERDIR** directive; setting it to something like `"/` would have the same effect, for root, as the first example above. If you are using Apache 1.3 or above, we strongly recommend that you include the following line in your server configuration files:

```
UserDir disabled root
```

Watching Your Logs

To keep up-to-date with what is actually going on against your server you have to check the Log Files (p. 29) . Even though the log files only reports what has already happened, they will give you some understanding of what attacks is thrown against the server and allow you to check if the necessary level of security is present.

A couple of examples:

```
grep -c "/jsp/source.jsp?/jsp/ /jsp/source.jsp??" access.log
grep "client denied" error_log | tail -n 10
```

The first example will list the number of attacks trying to exploit the Apache Tomcat Source.JSP Malformed Request Information Disclosure Vulnerability¹⁵, the second example will list the ten last denied clients, for example:

```
[Thu Jul 11 17:18:39 2002] [error] [client foo.bar.com] client denied
by server configuration: /usr/local/apache/htdocs/.htpasswd
```

As you can see, the log files only report what already has happened, so if the client had been able to access the `.htpasswd` file you would have seen something similar to:

```
foo.bar.com - - [12/Jul/2002:01:59:13 +0200] "GET /.htpasswd
HTTP/1.1"
```

in your Access Log (p. 29) . This means you probably commented out the following in your server configuration file:

```
<Files ~ "\.ht">
Order allow,deny
Deny from all
</Files>
```

¹⁵<http://online.securityfocus.com/bid/4876/info/>

2.10 Dynamic Shared Object (DSO) Support

The Apache HTTP Server is a modular program where the administrator can choose the functionality to include in the server by selecting a set of modules. The modules can be statically compiled into the `httpd` binary when the server is built. Alternatively, modules can be compiled as Dynamic Shared Objects (DSOs) that exist separately from the main `httpd` binary file. DSO modules may be compiled at the time the server is built, or they may be compiled and added at a later time using the Apache Extension Tool (`apxs`).

This document describes how to use DSO modules as well as the theory behind their use.

Implementation

Related Modules	Related Directives
MOD_SO	LOADMODULE

The DSO support for loading individual Apache modules is based on a module named `MOD_SO` which must be statically compiled into the Apache core. It is the only module besides `CORE` which cannot be put into a DSO itself. Practically all other distributed Apache modules can then be placed into a DSO by individually enabling the DSO build for them via `configure`'s `--enable-module=shared` option as discussed in the install documentation (p. 10). After a module is compiled into a DSO named `mod.foo.so` you can use `MOD_SO`'s `LOADMODULE` command in your `httpd.conf` file to load this module at server startup or restart.

To simplify this creation of DSO files for Apache modules (especially for third-party modules) a new support program named `apxs` (APache eXtenSion) is available. It can be used to build DSO based modules *outside of* the Apache source tree. The idea is simple: When installing Apache the `configure`'s `make install` procedure installs the Apache C header files and puts the platform-dependent compiler and linker flags for building DSO files into the `apxs` program. This way the user can use `apxs` to compile his Apache module sources without the Apache distribution source tree and without having to fiddle with the platform-dependent compiler and linker flags for DSO support.

Usage Summary

To give you an overview of the DSO features of Apache 2.x, here is a short and concise summary:

1. Build and install a *distributed* Apache module, say `mod.foo.c`, into its own DSO `mod.foo.so`:

```
$ ./configure --prefix=/path/to/install --enable-foo=shared
$ make install
```

2. Build and install a *third-party* Apache module, say `mod.foo.c`, into its own DSO `mod.foo.so`:

```
$ ./configure --add-module=module_type:/path/to/3rdparty/mod.foo.c
--enable-foo=shared
$ make install
```

3. Configure Apache for *later installation* of shared modules:

```
$ ./configure --enable-so
$ make install
```

4. Build and install a *third-party* Apache module, say `mod_foo.c`, into its own DSO `mod_foo.so` *outside of* the Apache source tree using `apxs`:

```
$ cd /path/to/3rdparty
$ apxs -c mod_foo.c
$ apxs -i -a -n foo mod_foo.la
```

In all cases, once the shared module is compiled, you must use a `LOADMODULE` directive in `httpd.conf` to tell Apache to activate the module.

Background

On modern Unix derivatives there exists a nifty mechanism usually called dynamic linking/loading of *Dynamic Shared Objects* (DSO) which provides a way to build a piece of program code in a special format for loading it at run-time into the address space of an executable program.

This loading can usually be done in two ways: Automatically by a system program called `ld.so` when an executable program is started or manually from within the executing program via a programmatic system interface to the Unix loader through the system calls `dlopen()` / `dlsym()`.

In the first way the DSO's are usually called *shared libraries* or *DSO libraries* and named `libfoo.so` or `libfoo.so.1.2`. They reside in a system directory (usually `/usr/lib`) and the link to the executable program is established at build-time by specifying `-lfoo` to the linker command. This hard-codes library references into the executable program file so that at start-time the Unix loader is able to locate `libfoo.so` in `/usr/lib`, in paths hard-coded via linker-options like `-R` or in paths configured via the environment variable `LD_LIBRARY_PATH`. It then resolves any (yet unresolved) symbols in the executable program which are available in the DSO.

Symbols in the executable program are usually not referenced by the DSO (because it's a reusable library of general code) and hence no further resolving has to be done. The executable program has no need to do anything on its own to use the symbols from the DSO because the complete resolving is done by the Unix loader. (In fact, the code to invoke `ld.so` is part of the run-time startup code which is linked into every executable program which has been bound non-static). The advantage of dynamic loading of common library code is obvious: the library code needs to be stored only once, in a system library like `libc.so`, saving disk space for every program.

In the second way the DSO's are usually called *shared objects* or *DSO files* and can be named with an arbitrary extension (although the canonical name is `foo.so`). These files usually stay inside a program-specific directory and there is no automatically established link to the executable program where they are used. Instead the executable program manually loads the DSO at run-time into its address space via `dlopen()`. At this time no resolving of symbols from the DSO for the executable program is done. But instead the Unix loader automatically resolves any (yet unresolved) symbols in the DSO from the set of symbols exported by the executable program and its already loaded DSO libraries (especially all symbols from the ubiquitous `libc.so`). This way the DSO gets knowledge of the executable program's symbol set as if it had been statically linked with it in the first place.

Finally, to take advantage of the DSO's API the executable program has to resolve particular symbols from the DSO via `dlsym()` for later use inside dispatch tables *etc.* In other words: The executable program has to manually resolve every symbol it needs to be able to use it. The advantage of such a mechanism is that optional program parts need not be loaded (and thus do not spend memory) until they are needed by the program in question. When required, these program parts can be loaded dynamically to extend the base program's functionality.

Although this DSO mechanism sounds straightforward there is at least one difficult step here: The resolving of symbols from the executable program for the DSO when using a DSO to extend a program (the second way). Why? Because "reverse resolving" DSO symbols from the executable program's symbol set is against the library design (where the library has no knowledge about the programs it is used by) and is neither available under all platforms nor standardized. In practice the executable program's global symbols are often not re-exported and thus not available for use in a DSO.

Finding a way to force the linker to export all global symbols is the main problem one has to solve when using DSO for extending a program at run-time.

The shared library approach is the typical one, because it is what the DSO mechanism was designed for, hence it is used for nearly all types of libraries the operating system provides. On the other hand using shared objects for extending a program is not used by a lot of programs.

As of 1998 there are only a few software packages available which use the DSO mechanism to actually extend their functionality at run-time: Perl 5 (via its XS mechanism and the DynaLoader module), Netscape Server, *etc.* Starting with version 1.3, Apache joined the crew, because Apache already uses a module concept to extend its functionality and internally uses a dispatch-list-based approach to link external modules into the Apache core functionality. So, Apache is really predestined for using DSO to load its modules at run-time.

Advantages and Disadvantages

The above DSO based features have the following advantages:

- The server package is more flexible at run-time because the actual server process can be assembled at run-time via `LOADMODULE` `httpd.conf` configuration commands instead of configure options at build-time. For instance this way one is able to run different server instances (standard & SSL version, minimalistic & powered up version [`mod_perl`, `PHP3`], *etc.*) with only one Apache installation.
- The server package can be easily extended with third-party modules even after installation. This is at least a great benefit for vendor package maintainers who can create a Apache core package and additional packages containing extensions like `PHP3`, `mod_perl`, `mod_fastcgi`, *etc.*
- Easier Apache module prototyping because with the DSO/apxs pair you can both work outside the Apache source tree and only need an `apxs -i` command followed by an `apachectl restart` to bring a new version of your currently developed module into the running Apache server.

DSO has the following disadvantages:

- The DSO mechanism cannot be used on every platform because not all operating systems support dynamic loading of code into the address space of a program.
- The server is approximately 20% slower at startup time because of the symbol resolving overhead the Unix loader now has to do.
- The server is approximately 5% slower at execution time under some platforms because position independent code (PIC) sometimes needs complicated assembler tricks for relative addressing which are not necessarily as fast as absolute addressing.
- Because DSO modules cannot be linked against other DSO-based libraries (`ld -lfoo`) on all platforms (for instance a.out-based platforms usually don't provide this functionality while ELF-based platforms do) you cannot use the DSO mechanism for all types of modules. Or in other words, modules compiled as DSO files are restricted to only use symbols from the Apache core, from the C library (`libc`) and all other dynamic or static libraries used by the Apache core, or from static library archives (`libfoo.a`) containing position independent code. The only chances to use other code is to either make sure the Apache core itself already contains a reference to it or loading the code yourself via `dlopen()`.

2.11 Content Negotiation

Apache supports content negotiation as described in the HTTP/1.1 specification. It can choose the best representation of a resource based on the browser-supplied preferences for media type, languages, character set and encoding. It also implements a couple of features to give more intelligent handling of requests from browsers that send incomplete negotiation information.

Content negotiation is provided by the `MOD_NEGOTIATION` module, which is compiled in by default.

About Content Negotiation

A resource may be available in several different representations. For example, it might be available in different languages or different media types, or a combination. One way of selecting the most appropriate choice is to give the user an index page, and let them select. However it is often possible for the server to choose automatically. This works because browsers can send, as part of each request, information about what representations they prefer. For example, a browser could indicate that it would like to see information in French, if possible, else English will do. Browsers indicate their preferences by headers in the request. To request only French representations, the browser would send

```
Accept-Language: fr
```

Note that this preference will only be applied when there is a choice of representations and they vary by language.

As an example of a more complex request, this browser has been configured to accept French and English, but prefer French, and to accept various media types, preferring HTML over plain text or other text types, and preferring GIF or JPEG over other media types, but also allowing any other media type as a last resort:

```
Accept-Language: fr; q=1.0, en; q=0.5  
Accept: text/html; q=1.0, text/*; q=0.8, image/gif; q=0.6,  
image/jpeg; q=0.6, image/*; q=0.5, */*; q=0.1
```

Apache supports 'server driven' content negotiation, as defined in the HTTP/1.1 specification. It fully supports the `Accept`, `Accept-Language`, `Accept-Charset` and `Accept-Encoding` request headers. Apache also supports 'transparent' content negotiation, which is an experimental negotiation protocol defined in RFC 2295 and RFC 2296. It does not offer support for 'feature negotiation' as defined in these RFCs.

A **resource** is a conceptual entity identified by a URI (RFC 2396). An HTTP server like Apache provides access to **representations** of the resource(s) within its namespace, with each representation in the form of a sequence of bytes with a defined media type, character set, encoding, etc. Each resource may be associated with zero, one, or more than one representation at any given time. If multiple representations are available, the resource is referred to as **negotiable** and each of its representations is termed a **variant**. The ways in which the variants for a negotiable resource vary are called the **dimensions** of negotiation.

Negotiation in Apache

In order to negotiate a resource, the server needs to be given information about each of the variants. This is done in one of two ways:

- Using a type map (*i.e.*, a `*.var` file) which names the files containing the variants explicitly, or
- Using a 'MultiViews' search, where the server does an implicit filename pattern match and chooses from among the results.

Using a type-map file

A type map is a document which is associated with the handler named `type-map` (or, for backwards-compatibility with older Apache configurations, the MIME type `application/x-type-map`). Note that to use this feature, you must have a handler set in the configuration that defines a file suffix as `type-map`; this is best done with

```
AddHandler type-map .var
```

in the server configuration file.

Type map files should have the same name as the resource which they are describing, and have an entry for each available variant; these entries consist of contiguous HTTP-format header lines. Entries for different variants are separated by blank lines. Blank lines are illegal within an entry. It is conventional to begin a map file with an entry for the combined entity as a whole (although this is not required, and if present will be ignored). An example map file is shown below. This file would be named `foo.var`, as it describes a resource named `foo`.

```
URI: foo
URI: foo.en.html
Content-type: text/html
Content-language: en
URI: foo.fr.de.html
Content-type: text/html; charset=iso-8859-2
Content-language: fr, de
```

Note also that a typemap file will take precedence over the filename's extension, even when Multiviews is on. If the variants have different source qualities, that may be indicated by the "qs" parameter to the media type, as in this picture (available as JPEG, GIF, or ASCII-art):

```
URI: foo
URI: foo.jpeg
Content-type: image/jpeg; qs=0.8
URI: foo.gif
Content-type: image/gif; qs=0.5
URI: foo.txt
Content-type: text/plain; qs=0.01
```

qs values can vary in the range 0.000 to 1.000. Note that any variant with a qs value of 0.000 will never be chosen. Variants with no 'qs' parameter value are given a qs factor of 1.0. The qs parameter indicates the relative 'quality' of this variant compared to the other available variants, independent of the client's capabilities. For example, a JPEG file is usually of higher source quality than an ASCII file if it is attempting to represent a photograph. However, if the resource being represented is an original ASCII art, then an ASCII representation would have a higher source quality than a JPEG representation. A qs value is therefore specific to a given variant depending on the nature of the resource it represents.

The full list of headers recognized is available in the `mod_negotiation typemap` (p. 499) documentation.

Multiviews

`MultiViews` is a per-directory option, meaning it can be set with an `OPTIONS` directive within a `<DIRECTORY>`, `<LOCATION>` or `<FILES>` section in `httpd.conf`, or (if `ALLOWOVERRIDE` is properly set) in `.htaccess` files. Note that `Options All` does not set `MultiViews`; you have to ask for it by name.

The effect of `MultiViews` is as follows: if the server receives a request for `/some/dir/foo`, if `/some/dir` has `MultiViews` enabled, and `/some/dir/foo` does *not* exist, then the server reads the directory looking for files named `foo.*`, and effectively fakes up a type map which names all those files, assigning them the same media types and content-encodings it would have if the client had asked for one of them by name. It then chooses the best match to the client's requirements.

`MultiViews` may also apply to searches for the file named by the `DIRECTORYINDEX` directive, if the server is trying to index a directory. If the configuration files specify

```
DirectoryIndex index
```

then the server will arbitrate between `index.html` and `index.html3` if both are present. If neither are present, and `index.cgi` is there, the server will run it.

If one of the files found when reading the directory does not have an extension recognized by `mod_mime` to designate its Charset, Content-Type, Language, or Encoding, then the result depends on the setting of the `MULTIVIEWSMATCH` directive. This directive determines whether handlers, filters, and other extension types can participate in `MultiViews` negotiation.

The Negotiation Methods

After Apache has obtained a list of the variants for a given resource, either from a type-map file or from the filenames in the directory, it invokes one of two methods to decide on the 'best' variant to return, if any. It is not necessary to know any of the details of how negotiation actually takes place in order to use Apache's content negotiation features. However the rest of this document explains the methods used for those interested.

There are two negotiation methods:

1. **Server driven negotiation with the Apache algorithm** is used in the normal case. The Apache algorithm is explained in more detail below. When this algorithm is used, Apache can sometimes 'fiddle' the quality factor of a particular dimension to achieve a better result. The ways Apache can fiddle quality factors is explained in more detail below.
2. **Transparent content negotiation** is used when the browser specifically requests this through the mechanism defined in RFC 2295. This negotiation method gives the browser full control over deciding on the 'best' variant, the result is therefore dependent on the specific algorithms used by the browser. As part of the transparent negotiation process, the browser can ask Apache to run the 'remote variant selection algorithm' defined in RFC 2296.

Dimensions of Negotiation

Dimension	Notes
Media Type	Browser indicates preferences with the <code>Accept</code> header field. Each item can have an associated quality factor. Variant description can also have a quality factor (the "qs" parameter).
Language	Browser indicates preferences with the <code>Accept-Language</code> header field. Each item can have a quality factor. Variants can be associated with none, one or more than one language.
Encoding	Browser indicates preference with the <code>Accept-Encoding</code> header field. Each item can have a quality factor.
Charset	Browser indicates preference with the <code>Accept-Charset</code> header field. Each item can have a quality factor. Variants can indicate a charset as a parameter of the media type.

Apache Negotiation Algorithm

Apache can use the following algorithm to select the 'best' variant (if any) to return to the browser. This algorithm is not further configurable. It operates as follows:

1. First, for each dimension of the negotiation, check the appropriate *Accept** header field and assign a quality to each variant. If the *Accept** header for any dimension implies that this variant is not acceptable, eliminate it. If no variants remain, go to step 4.
2. Select the 'best' variant by a process of elimination. Each of the following tests is applied in order. Any variants not selected at each test are eliminated. After each test, if only one variant remains, select it as the best match and proceed to step 3. If more than one variant remains, move on to the next test.
 - (a) Multiply the quality factor from the `Accept` header with the quality-of-source factor for this variants media type, and select the variants with the highest value.
 - (b) Select the variants with the highest language quality factor.
 - (c) Select the variants with the best language match, using either the order of languages in the `Accept-Language` header (if present), or else the order of languages in the `LanguagePriority` directive (if present).
 - (d) Select the variants with the highest 'level' media parameter (used to give the version of text/html media types).
 - (e) Select variants with the best charset media parameters, as given on the `Accept-Charset` header line. `Charset ISO-8859-1` is acceptable unless explicitly excluded. Variants with a `text/*` media type but not explicitly associated with a particular charset are assumed to be in ISO-8859-1.
 - (f) Select those variants which have associated charset media parameters that are *not* ISO-8859-1. If there are no such variants, select all variants instead.
 - (g) Select the variants with the best encoding. If there are variants with an encoding that is acceptable to the user-agent, select only these variants. Otherwise if there is a mix of encoded and non-encoded variants, select only the unencoded variants. If either all variants are encoded or all variants are not encoded, select all variants.
 - (h) Select the variants with the smallest content length.
 - (i) Select the first variant of those remaining. This will be either the first listed in the type-map file, or when variants are read from the directory, the one whose file name comes first when sorted using ASCII code order.
3. The algorithm has now selected one 'best' variant, so return it as the response. The HTTP response header `Vary` is set to indicate the dimensions of negotiation (browsers and caches can use this information when caching the resource). End.
4. To get here means no variant was selected (because none are acceptable to the browser). Return a 406 status (meaning "No acceptable representation") with a response body consisting of an HTML document listing the available variants. Also set the HTTP `Vary` header to indicate the dimensions of variance.

Fiddling with Quality Values

Apache sometimes changes the quality values from what would be expected by a strict interpretation of the Apache negotiation algorithm above. This is to get a better result from the algorithm for browsers which do not send full or accurate information. Some of the most popular browsers send `Accept` header information which would otherwise result in the selection of the wrong variant in many cases. If a browser sends full and correct information these fiddles will not be applied.

Media Types and Wildcards

The `Accept` : request header indicates preferences for media types. It can also include 'wildcard' media types, such as "image/*" or "*/*" where the * matches any string. So a request including:

```
Accept: image/*, */*
```

would indicate that any type starting "image/" is acceptable, as is any other type. Some browsers routinely send wildcards in addition to explicit types they can handle. For example:

```
Accept: text/html, text/plain, image/gif, image/jpeg, */*
```

The intention of this is to indicate that the explicitly listed types are preferred, but if a different representation is available, that is ok too. Using explicit quality values, what the browser really wants is something like:

```
Accept: text/html, text/plain, image/gif, image/jpeg, */*; q=0.01
```

The explicit types have no quality factor, so they default to a preference of 1.0 (the highest). The wildcard */* is given a low preference of 0.01, so other types will only be returned if no variant matches an explicitly listed type.

If the `Accept:` header contains *no* q factors at all, Apache sets the q value of "*/*", if present, to 0.01 to emulate the desired behavior. It also sets the q value of wildcards of the format "type/*" to 0.02 (so these are preferred over matches against "*/*"). If any media type on the `Accept:` header contains a q factor, these special values are *not* applied, so requests from browsers which send the explicit information to start with work as expected.

Language Negotiation Exceptions

New in Apache 2.0, some exceptions have been added to the negotiation algorithm to allow graceful fallback when language negotiation fails to find a match.

When a client requests a page on your server, but the server cannot find a single page that matches the `Accept-language` sent by the browser, the server will return either a "No Acceptable Variant" or "Multiple Choices" response to the client. To avoid these error messages, it is possible to configure Apache to ignore the `Accept-language` in these cases and provide a document that does not explicitly match the client's request. The `FORCELANGUAGEPRIORITY` directive can be used to override one or both of these error messages and substitute the server's judgement in the form of the `LANGUAGEPRIORITY` directive.

The server will also attempt to match language-subsets when no other match can be found. For example, if a client requests documents with the language `en-GB` for British English, the server is not normally allowed by the HTTP/1.1 standard to match that against a document that is marked as simply `en`. (Note that it is almost surely a configuration error to include `en-GB` and not `en` in the `Accept-Language` header, since it is very unlikely that a reader understands British English, but doesn't understand English in general. Unfortunately, many current clients have default configurations that resemble this.) However, if no other language match is possible and the server is about to return a "No Acceptable Variants" error or fallback to the `LANGUAGEPRIORITY`, the server will ignore the subset specification and match `en-GB` against `en` documents. Implicitly, Apache will add the parent language to the client's acceptable language list with a very low quality value. But note that if the client requests "`en-GB; q=0.9, fr; q=0.8`", and the server has documents designated "`en`" and "`fr`", then the "`fr`" document will be returned. This is necessary to maintain compliance with the HTTP/1.1 specification and to work effectively with properly configured clients.

In order to support advanced techniques (such as cookies or special URL-paths) to determine the user's preferred language, since Apache 2.0.47 `MOD_NEGOTIATION` recognizes the environment variable (p. 60) `prefer-language`. If it exists and contains an appropriate language tag, `MOD_NEGOTIATION` will try to select a matching variant. If there's no such variant, the normal negotiation process applies.

Example

```
SetEnvIf Cookie "language=en" prefer-language=en
SetEnvIf Cookie "language=fr" prefer-language=fr
```

Extensions to Transparent Content Negotiation

Apache extends the transparent content negotiation protocol (RFC 2295) as follows. A new `{encoding . .}` element is used in variant lists to label variants which are available with a specific content-encoding only. The implementation of the RVSA/1.0 algorithm (RFC 2296) is extended to recognize encoded variants in the list, and to use them as candidate variants whenever their encodings are acceptable according to the `Accept-Encoding` request header. The RVSA/1.0 implementation does not round computed quality factors to 5 decimal places before choosing the best variant.

Note on hyperlinks and naming conventions

If you are using language negotiation you can choose between different naming conventions, because files can have more than one extension, and the order of the extensions is normally irrelevant (see the `mod_mime` (p. 483) documentation for details).

A typical file has a MIME-type extension (*e.g.*, `html`), maybe an encoding extension (*e.g.*, `gz`), and of course a language extension (*e.g.*, `en`) when we have different language variants of this file.

Examples:

- `foo.en.html`
- `foo.html.en`
- `foo.en.html.gz`

Here some more examples of filenames together with valid and invalid hyperlinks:

Filename	Valid hyperlink	Invalid hyperlink
<i>foo.html.en</i>	<code>foo</code> <code>foo.html</code>	-
<i>foo.en.html</i>	<code>foo</code>	<code>foo.html</code>
<i>foo.html.en.gz</i>	<code>foo</code> <code>foo.html</code>	<code>foo.gz</code> <code>foo.html.gz</code>
<i>foo.en.html.gz</i>	<code>foo</code>	<code>foo.html</code> <code>foo.html.gz</code> <code>foo.gz</code>
<i>foo.gz.html.en</i>	<code>foo</code> <code>foo.gz</code> <code>foo.gz.html</code>	<code>foo.html</code>
<i>foo.html.gz.en</i>	<code>foo</code> <code>foo.html</code> <code>foo.html.gz</code>	<code>foo.gz</code>

Looking at the table above, you will notice that it is always possible to use the name without any extensions in a hyperlink (*e.g.*, `foo`). The advantage is that you can hide the actual type of a document resp. file and can change it later, *e.g.*, from `html` to `shtml` or `cgi` without changing any hyperlink references.

If you want to continue to use a MIME-type in your hyperlinks (*e.g.* `foo.html`) the language extension (including an encoding extension if there is one) must be on the right hand side of the MIME-type extension (*e.g.*, `foo.html.en`).

Note on Caching

When a cache stores a representation, it associates it with the request URL. The next time that URL is requested, the cache can use the stored representation. But, if the resource is negotiable at the server, this might result in only the first requested variant being cached and subsequent cache hits might return the wrong response. To prevent this,

Apache normally marks all responses that are returned after content negotiation as non-cacheable by HTTP/1.0 clients. Apache also supports the HTTP/1.1 protocol features to allow caching of negotiated responses.

For requests which come from a HTTP/1.0 compliant client (either a browser or a cache), the directive `CACHENEGOTIATEDOCS` can be used to allow caching of responses which were subject to negotiation. This directive can be given in the server config or virtual host, and takes no arguments. It has no effect on requests from HTTP/1.1 clients.

More Information

For more information about content negotiation, see Alan J. Flavell's Language Negotiation Notes¹⁶. But note that this document may not be updated to include changes in Apache 2.0.

¹⁶<http://ppewww.ph.gla.ac.uk/~flavell/www/lang-neg.html>

2.12 Custom Error Responses

Additional functionality allows webmasters to configure the response of Apache to some error or problem.

Customizable responses can be defined to be activated in the event of a server detected error or problem.

If a script crashes and produces a "500 Server Error" response, then this response can be replaced with either some friendlier text or by a redirection to another URL (local or external).

Behavior

Old Behavior

NCSA httpd 1.3 would return some boring old error/problem message which would often be meaningless to the user, and would provide no means of logging the symptoms which caused it.

New Behavior

The server can be asked to:

1. Display some other text, instead of the NCSA hard coded messages, or
2. redirect to a local URL, or
3. redirect to an external URL.

Redirecting to another URL can be useful, but only if some information can be passed which can then be used to explain and/or log the error/problem more clearly.

To achieve this, Apache will define new CGI-like environment variables:

```
REDIRECT_HTTP_ACCEPT=*/, image/gif, image/x-xbitmap, image/jpeg
REDIRECT_HTTP_USER_AGENT=Mozilla/1.1b2 (X11; I; HP-UX A.09.05
9000/712)
REDIRECT_PATH=./bin:/usr/local/bin:/etc
REDIRECT_QUERY_STRING=
REDIRECT_REMOTE_ADDR=121.345.78.123
REDIRECT_REMOTE_HOST=ooh.ahhh.com
REDIRECT_SERVER_NAME=crash.bang.edu
REDIRECT_SERVER_PORT=80
REDIRECT_SERVER_SOFTWARE=Apache/0.8.15
REDIRECT_URL=/cgi-bin/buggy.pl
```

Note the REDIRECT_ prefix.

At least REDIRECT_URL and REDIRECT_QUERY_STRING will be passed to the new URL (assuming it's a cgi-script or a cgi-include). The other variables will exist only if they existed prior to the error/problem. **None** of these will be set if your [ERRORDOCUMENT](#) is an *external* redirect (anything starting with a scheme name like http:, even if it refers to the same host as the server).

Configuration

Use of `ERRORDOCUMENT` is enabled for `.htaccess` files when the `ALLOWOVERRIDE` is set accordingly.

Here are some examples...

```
ErrorDocument 500 /cgi-bin/crash-recover
ErrorDocument 500 "Sorry, our script crashed. Oh dear"
ErrorDocument 500 http://xxx/
ErrorDocument 404 /Lame_excuses/not_found.html
ErrorDocument 401 /Subscription/how_to_subscribe.html
```

The syntax is,

```
ErrorDocument <3-digit-code> <action>
```

where the action can be,

1. Text to be displayed. Prefix the text with a quote (`"`). Whatever follows the quote is displayed. *Note: the (`"`) prefix isn't displayed.*
2. An external URL to redirect to.
3. A local URL to redirect to.

Custom Error Responses and Redirects

Apache's behavior to redirected URLs has been modified so that additional environment variables are available to a script/server-include.

Old behavior

Standard CGI vars were made available to a script which has been redirected to. No indication of where the redirection came from was provided.

New behavior

A new batch of environment variables will be initialized for use by a script which has been redirected to. Each new variable will have the prefix `REDIRECT_`. `REDIRECT_` environment variables are created from the CGI environment variables which existed prior to the redirect, they are renamed with a `REDIRECT_` prefix, *i.e.*, `HTTP_USER_AGENT` becomes `REDIRECT_HTTP_USER_AGENT`. In addition to these new variables, Apache will define `REDIRECT_URL` and `REDIRECT_STATUS` to help the script trace its origin. Both the original URL and the URL being redirected to can be logged in the access log.

If the `ErrorDocument` specifies a local redirect to a CGI script, the script should include a `"Status: "` header field in its output in order to ensure the propagation all the way back to the client of the error condition that caused it to be invoked. For instance, a Perl `ErrorDocument` script might include the following:

```
...
print "Content-type: text/html\n";
printf "Status: %s Condition Intercepted\n", $ENV{"REDIRECT_STATUS"};
...
```

If the script is dedicated to handling a particular error condition, such as `404NotFound`, it can use the specific code and error text instead.

Note that the script *must* emit an appropriate `Status:` header (such as `302Found`), if the response contains a `Location:` header (in order to issue a client side redirect). Otherwise the `Location:` header may have no effect.

2.13 Binding

Configuring Apache to listen on specific addresses and ports.

See also

- [Virtual Hosts](#) (p. 110)
- [DNS Issues](#) (p. 136)

Overview

Related Modules	Related Directives
CORE	<VIRTUALHOST>
MPM_COMMON	LISTEN

When Apache starts, it binds to some port and address on the local machine and waits for incoming requests. By default, it listens to all addresses on the machine. However, it needs to be told to listen on specific ports, or to listen on only selected addresses, or a combination. This is often combined with the Virtual Host feature which determines how Apache responds to different IP addresses, hostnames and ports.

The [LISTEN](#) directive tells the server to accept incoming requests only on the specified port or address-and-port combinations. If only a port number is specified in the [LISTEN](#) directive, the server listens to the given port on all interfaces. If an IP address is given as well as a port, the server will listen on the given port and interface. Multiple [LISTEN](#) directives may be used to specify a number of addresses and ports to listen on. The server will respond to requests from any of the listed addresses and ports.

For example, to make the server accept connections on both port 80 and port 8000, use:

```
Listen 80
Listen 8000
```

To make the server accept connections on two specified interfaces and port numbers, use

```
Listen 192.170.2.1:80
Listen 192.170.2.5:8000
```

IPv6 addresses must be surrounded in square brackets, as in the following example:

```
Listen [2001:db8::a00:20ff:fea7:ccea]:80
```

Special IPv6 Considerations

A growing number of platforms implement IPv6, and APR supports IPv6 on most of these platforms, allowing Apache to allocate IPv6 sockets and handle requests which were sent over IPv6.

One complicating factor for Apache administrators is whether or not an IPv6 socket can handle both IPv4 connections and IPv6 connections. Handling IPv4 connections with an IPv6 socket uses IPv4-mapped IPv6 addresses, which are allowed by default on most platforms but are disallowed by default on FreeBSD, NetBSD, and OpenBSD in order to match the system-wide policy on those platforms. But even on systems where it is disallowed by default, a special configure parameter can change this behavior for Apache.

If you want Apache to handle IPv4 and IPv6 connections with a minimum of sockets, which requires using IPv4-mapped IPv6 addresses, specify the `--enable-v4-mapped` configure option and use generic `LISTEN` directives like the following:

```
Listen 80
```

With `--enable-v4-mapped`, the `Listen` directives in the default configuration file created by Apache will use this form. `--enable-v4-mapped` is the default on all platforms but FreeBSD, NetBSD, and OpenBSD, so this is probably how your Apache was built.

If you want Apache to handle IPv4 connections only, regardless of what your platform and APR will support, specify an IPv4 address on all `LISTEN` directives, as in the following examples:

```
Listen 0.0.0.0:80
Listen 192.170.2.1:80
```

If you want Apache to handle IPv4 and IPv6 connections on separate sockets (i.e., to disable IPv4-mapped addresses), specify the `--disable-v4-mapped` configure option and use specific `Listen` directives like the following:

```
Listen [::]:80
Listen 0.0.0.0:80
```

With `--disable-v4-mapped`, the `Listen` directives in the default configuration file created by Apache will use this form. `--disable-v4-mapped` is the default on FreeBSD, NetBSD, and OpenBSD.

How This Works With Virtual Hosts

`LISTEN` does not implement Virtual Hosts. It only tells the main server what addresses and ports to listen to. If no `<VIRTUALHOST>` directives are used, the server will behave the same for all accepted requests. However, `<VIRTUALHOST>` can be used to specify a different behavior for one or more of the addresses and ports. To implement a `VirtualHost`, the server must first be told to listen to the address and port to be used. Then a `<VIRTUALHOST>` section should be created for a specified address and port to set the behavior of this virtual host. Note that if the `<VIRTUALHOST>` is set for an address and port that the server is not listening to, it cannot be accessed.

2.14 Multi-Processing Modules (MPMs)

This document describes what a Multi-Processing Module is and how they are used by the Apache HTTP Server.

Introduction

The Apache HTTP Server is designed to be a powerful and flexible web server that can work on a very wide variety of platforms in a range of different environments. Different platforms and different environments often require different features, or may have different ways of implementing the same feature most efficiently. Apache has always accommodated a wide variety of environments through its modular design. This design allows the webmaster to choose which features will be included in the server by selecting which modules to load either at compile-time or at run-time.

Apache 2.0 extends this modular design to the most basic functions of a web server. The server ships with a selection of Multi-Processing Modules (MPMs) which are responsible for binding to network ports on the machine, accepting requests, and dispatching children to handle the requests.

Extending the modular design to this level of the server allows two important benefits:

- Apache can more cleanly and efficiently support a wide variety of operating systems. In particular, the Windows version of Apache is now much more efficient, since [MPM_WINNT](#) can use native networking features in place of the POSIX layer used in Apache 1.3. This benefit also extends to other operating systems that implement specialized MPMs.
- The server can be better customized for the needs of the particular site. For example, sites that need a great deal of scalability can choose to use a threaded MPM like [WORKER](#), while sites requiring stability or compatibility with older software can use a [PREFORK](#). In addition, special features like serving different hosts under different userids ([PERCHILD](#)) can be provided.

At the user level, MPMs appear much like other Apache modules. The main difference is that one and only one MPM must be loaded into the server at any time. The list of available MPMs appears on the module index page (p. [660](#)).

Choosing an MPM

MPMs must be chosen during configuration, and compiled into the server. Compilers are capable of optimizing a lot of functions if threads are used, but only if they know that threads are being used.

To actually choose the desired MPM, use the argument `--with-mpm=NAME` with the configure script. *NAME* is the name of the desired MPM.

Once the server has been compiled, it is possible to determine which MPM was chosen by using `./httpd -l`. This command will list every module that is compiled into the server, including the MPM.

MPM Defaults

The following table lists the default MPMs for various operating systems. This will be the MPM selected if you do not make another choice at compile-time.

BeOS	BEOS
Netware	MPM_NETWARE
OS/2	MPMT_OS2
Unix	PREFORK
Windows	MPM_WINNT

2.15 Environment Variables in Apache

The Apache HTTP Server provides a mechanism for storing information in named variables that are called *environment variables*. This information can be used to control various operations such as logging or access control. The variables are also used as a mechanism to communicate with external programs such as CGI scripts. This document discusses different ways to manipulate and use these variables.

Although these variables are referred to as *environment variables*, they are not the same as the environment variables controlled by the underlying operating system. Instead, these variables are stored and manipulated in an internal Apache structure. They only become actual operating system environment variables when they are provided to CGI scripts and Server Side Include scripts. If you wish to manipulate the operating system environment under which the server itself runs, you must use the standard environment manipulation mechanisms provided by your operating system shell.

Setting Environment Variables

Related Modules	Related Directives
MOD_ENV	BROWSERMATCH
MOD_REWRITE	BROWSERMATCHNOCASE
MOD_SETENVIF	PASSENV
MOD_UNIQUE_ID	REWRITERULE
	SETENV
	SETENVIF
	SETENVIFNOCASE
	UNSETENV

Basic Environment Manipulation

The most basic way to set an environment variable in Apache is using the unconditional [SETENV](#) directive. Variables may also be passed from the environment of the shell which started the server using the [PASSENV](#) directive.

Conditional Per-Request Settings

For additional flexibility, the directives provided by `mod_setenvif` allow environment variables to be set on a per-request basis, conditional on characteristics of particular requests. For example, a variable could be set only when a specific browser (User-Agent) is making a request, or only when a specific Referer [sic] header is found. Even more flexibility is available through the `mod_rewrite`'s [REWRITERULE](#) which uses the `[E= . . .]` option to set environment variables.

Unique Identifiers

Finally, `mod_unique_id` sets the environment variable `UNIQUE_ID` for each request to a value which is guaranteed to be unique across "all" requests under very specific conditions.

Standard CGI Variables

In addition to all environment variables set within the Apache configuration and passed from the shell, CGI scripts and SSI pages are provided with a set of environment variables containing meta-information about the request as required

by the CGI specification¹⁷.

Some Caveats

- It is not possible to override or change the standard CGI variables using the environment manipulation directives.
- When `suexec` is used to launch CGI scripts, the environment will be cleaned down to a set of *safe* variables before CGI scripts are launched. The list of *safe* variables is defined at compile-time in `suexec.c`.
- For portability reasons, the names of environment variables may contain only letters, numbers, and the underscore character. In addition, the first character may not be a number. Characters which do not match this restriction will be replaced by an underscore when passed to CGI scripts and SSI pages.

Using Environment Variables

Related Modules	Related Directives
MOD_ACCESS	ALLOW
MOD_CGI	CUSTOMLOG
MOD_EXT_FILTER	DENY
MOD_HEADERS	EXTFILTERDEFINE
MOD_INCLUDE	HEADER
MOD_LOG_CONFIG	LOGFORMAT
MOD_REWRITE	REWRITECOND
	REWRITERULE

CGI Scripts

One of the primary uses of environment variables is to communicate information to CGI scripts. As discussed above, the environment passed to CGI scripts includes standard meta-information about the request in addition to any variables set within the Apache configuration. For more details, see the CGI tutorial (p. 185).

SSI Pages

Server-parsed (SSI) documents processed by `mod_include`'s `INCLUDES` filter can print environment variables using the `echo` element, and can use environment variables in flow control elements to make parts of a page conditional on characteristics of a request. Apache also provides SSI pages with the standard CGI environment variables as discussed above. For more details, see the SSI tutorial (p. 191).

Access Control

Access to the server can be controlled based on the value of environment variables using the `allow from env=` and `deny from env=` directives. In combination with `SETENVIF`, this allows for flexible control of access to the server based on characteristics of the client. For example, you can use these directives to deny access to a particular browser (User-Agent).

¹⁷<http://cgi-spec.golux.com/>

Conditional Logging

Environment variables can be logged in the access log using the `LOGFORMAT` option `%e`. In addition, the decision on whether or not to log requests can be made based on the status of environment variables using the conditional form of the `CUSTOMLOG` directive. In combination with `SETENVIF` this allows for flexible control of which requests are logged. For example, you can choose not to log requests for filenames ending in `gif`, or you can choose to only log requests from clients which are outside your subnet.

Conditional Response Headers

The `HEADER` directive can use the presence or absence of an environment variable to determine whether or not a certain HTTP header will be placed in the response to the client. This allows, for example, a certain response header to be sent only if a corresponding header is received in the request from the client.

External Filter Activation

External filters configured by `MOD_EXT_FILTER` using the `EXTFILTERDEFINE` directive can be activated conditional on an environment variable using the `disableenv=` and `enableenv=` options.

URL Rewriting

The `%{ENV: . . . }` form of *TestString* in the `REWRITECOND` allows `mod_rewrite`'s rewrite engine to make decisions conditional on environment variables. Note that the variables accessible in `mod_rewrite` without the `ENV:` prefix are not actually environment variables. Rather, they are variables special to `mod_rewrite` which cannot be accessed from other modules.

Special Purpose Environment Variables

Interoperability problems have led to the introduction of mechanisms to modify the way Apache behaves when talking to particular clients. To make these mechanisms as flexible as possible, they are invoked by defining environment variables, typically with `BROWSERMATCH`, though `SETENV` and `PASSENV` could also be used, for example.

downgrade-1.0

This forces the request to be treated as a HTTP/1.0 request even if it was in a later dialect.

force-no-vary

This causes any `Vary` fields to be removed from the response header before it is sent back to the client. Some clients don't interpret this field correctly (see the known client problems (p. 286) page); setting this variable can work around this problem. Setting this variable also implies **force-response-1.0**.

force-response-1.0

This forces an HTTP/1.0 response to clients making an HTTP/1.0 request. It was originally implemented as a result of a problem with AOL's proxies. Some HTTP/1.0 clients may not behave correctly when given an HTTP/1.1 response, and this can be used to interoperate with them.

gzip-only-text/html

When set to a value of "1", this variable disables the DEFLATE output filter provided by [MOD_DEFLATE](#) for content-types other than `text/html`.

no-gzip

When set, the DEFLATE filter of [MOD_DEFLATE](#) will be turned off.

nokeepalive

This disables [KEEPALIVE](#) when set.

prefer-language

This influences [MOD_NEGOTIATION](#)'s behaviour. If it contains a language tag (such as `en`, `ja` or `x-klingon`), [MOD_NEGOTIATION](#) tries to deliver a variant with that language. If there's no such variant, the normal negotiation (p. 47) process applies.

redirect-carefully

This forces the server to be more careful when sending a redirect to the client. This is typically used when a client has a known problem handling redirects. This was originally implemented as a result of a problem with Microsoft's WebFolders software which has a problem handling redirects on directory resources via DAV methods.

suppress-error-charset

Available in versions after 2.0.54

When Apache issues a redirect in response to a client request, the response includes some actual text to be displayed in case the client can't (or doesn't) automatically follow the redirection. Apache ordinarily labels this text according to the character set which it uses, which is ISO-8859-1.

However, if the redirection is to a page that uses a different character set, some broken browser versions will try to use the character set from the redirection text rather than the actual page. This can result in Greek, for instance, being incorrectly rendered.

Setting this environment variable causes Apache to omit the character set for the redirection text, and these broken browsers will then correctly use that of the destination page.

Examples**Changing protocol behavior with misbehaving clients**

We recommend that the following lines be included in `httpd.conf` to deal with known client problems.

```
#
# The following directives modify normal HTTP response behavior.
# The first directive disables keepalive for Netscape 2.x and browsers that
# spoof it. There are known problems with these browser implementations.
# The second directive is for Microsoft Internet Explorer 4.0b2
# which has a broken HTTP/1.1 implementation and does not properly
# support keepalive when it is used on 301 or 302 (redirect) responses.
#
BrowserMatch "Mozilla/2" nokeepalive
BrowserMatch "MSIE 4\.0b2;" nokeepalive downgrade-1.0 force-response-1.0

#
# The following directive disables HTTP/1.1 responses to browsers which
# are in violation of the HTTP/1.0 spec by not being able to grok a
# basic 1.1 response.
#
BrowserMatch "RealPlayer 4\.0" force-response-1.0
BrowserMatch "Java/1\.0" force-response-1.0
BrowserMatch "JDK/1\.0" force-response-1.0
```

Do not log requests for images in the access log

This example keeps requests for images from appearing in the access log. It can be easily modified to prevent logging of particular directories, or to prevent logging of requests coming from particular hosts.

```
SetEnvIf Request_URI \.gif image-request
SetEnvIf Request_URI \.jpg image-request
SetEnvIf Request_URI \.png image-request
CustomLog logs/access_log common env=!image-request
```

Prevent "Image Theft"

This example shows how to keep people not on your server from using images on your server as inline-images on their pages. This is not a recommended configuration, but it can work in limited circumstances. We assume that all your images are in a directory called /web/images.

```
SetEnvIf Referer "^http://www.example.com/" local_referal
# Allow browsers that do not send Referer info
SetEnvIf Referer "^$" local_referal
<Directory /web/images>
    Order Deny,Allow
    Deny from all
    Allow from env=local_referal
</Directory>
```

For more information about this technique, see the ApacheToday tutorial " Keeping Your Images from Adorning Other Sites"¹⁸.

¹⁸http://apachetoday.com/news_story.php3?itsn=2000-06-14-002-01-PS

2.16 Apache's Handler Use

This document describes the use of Apache's Handlers.

What is a Handler

Related Modules	Related Directives
MOD_ACTIONS	ACTION
MOD_ASIS	ADDFHANDLER
MOD_CGI	REMOVEHANDLER
MOD_IMAP	SETHANDLER
MOD_INFO	
MOD_MIME	
MOD_NEGOTIATION	
MOD_STATUS	

A "handler" is an internal Apache representation of the action to be performed when a file is called. Generally, files have implicit handlers, based on the file type. Normally, all files are simply served by the server, but certain file types are "handled" separately.

Apache 1.1 adds the ability to use handlers explicitly. Based on either filename extensions or on location, handlers can be specified without relation to file type. This is advantageous both because it is a more elegant solution, and because it also allows for both a type **and** a handler to be associated with a file. (See also Files with Multiple Extensions (p. 483) .)

Handlers can either be built into the server or included in a module, or they can be added with the [ACTION](#) directive. The built-in handlers in the standard distribution are as follows:

- **default-handler:** Send the file using the `default_handler()`, which is the handler used by default to handle static content. (core)
- **send-as-is:** Send file with HTTP headers as is. ([MOD_ASIS](#))
- **cgi-script:** Treat the file as a CGI script. ([MOD_CGI](#))
- **imap-file:** Parse as an imagemap rule file. ([MOD_IMAP](#))
- **server-info:** Get the server's configuration information. ([MOD_INFO](#))
- **server-status:** Get the server's status report. ([MOD_STATUS](#))
- **type-map:** Parse as a type map file for content negotiation. ([MOD_NEGOTIATION](#))

Examples

Modifying static content using a CGI script

The following directives will cause requests for files with the `html` extension to trigger the launch of the `footer.pl` CGI script.

```
Action add-footer /cgi-bin/footer.pl
AddHandler add-footer .html
```

Then the CGI script is responsible for sending the originally requested document (pointed to by the `PATH_TRANSLATED` environment variable) and making whatever modifications or additions are desired.

Files with HTTP headers

The following directives will enable the `send-as-is` handler, which is used for files which contain their own HTTP headers. All files in the `/web/htdocs/asis/` directory will be processed by the `send-as-is` handler, regardless of their filename extensions.

```
<Directory /web/htdocs/asis>
SetHandler send-as-is
</Directory>
```

Programmer's Note

In order to implement the handler features, an addition has been made to the Apache API (p. 621) that you may wish to make use of. Specifically, a new record has been added to the `request_rec` structure:

```
char *handler
```

If you wish to have your module engage a handler, you need only to set `r->handler` to the name of the handler at any time prior to the `invoke_handler` stage of the request. Handlers are implemented as they were before, albeit using the handler name instead of a content type. While it is not necessary, the naming convention for handlers is to use a dash-separated word, with no slashes, so as to not invade the media type name-space.

2.17 Filters

This document describes the use of filters in Apache.

Filters

Related Modules	Related Directives
MOD_DEFLATE	ADDINPUTFILTER
MOD_EXT_FILTER	ADDOUTPUTFILTER
MOD_INCLUDE	REMOVEINPUTFILTER
	REMOVEOUTPUTFILTER
	EXTFILTERDEFINE
	EXTFILTEROPTIONS
	SETINPUTFILTER
	SETOUTPUTFILTER

A *filter* is a process that is applied to data that is sent or received by the server. Data sent by clients to the server is processed by *input filters* while data sent by the server to the client is processed by *output filters*. Multiple filters can be applied to the data, and the order of the filters can be explicitly specified.

Filters are used internally by Apache to perform functions such as chunking and byte-range request handling. In addition, modules can provide filters that are selectable using run-time configuration directives. The set of filters that apply to data can be manipulated with the [SETINPUTFILTER](#), [SETOUTPUTFILTER](#), [ADDINPUTFILTER](#), [ADDOUTPUTFILTER](#), [REMOVEINPUTFILTER](#), and [REMOVEOUTPUTFILTER](#) directives.

The following user-selectable filters are currently provided with the Apache HTTP Server distribution.

INCLUDES Server-Side Includes processing by [MOD_INCLUDE](#)

DEFLATE Compress output before sending it to the client using [MOD_DEFLATE](#)

In addition, the module [MOD_EXT_FILTER](#) allows for external programs to be defined as filters.

2.18 suEXEC Support

The **suEXEC** feature provides Apache users the ability to run **CGI** and **SSI** programs under user IDs different from the user ID of the calling web-server. Normally, when a CGI or SSI program executes, it runs as the same user who is running the web server.

Used properly, this feature can reduce considerably the security risks involved with allowing users to develop and run private CGI or SSI programs. However, if suEXEC is improperly configured, it can cause any number of problems and possibly create new holes in your computer's security. If you aren't familiar with managing *setuid root* programs and the security issues they present, we highly recommend that you not consider using suEXEC.

Before we begin

Before jumping head-first into this document, you should be aware of the assumptions made on the part of the Apache Group and this document.

First, it is assumed that you are using a UNIX derivative operating system that is capable of **setuid** and **setgid** operations. All command examples are given in this regard. Other platforms, if they are capable of supporting suEXEC, may differ in their configuration.

Second, it is assumed you are familiar with some basic concepts of your computer's security and its administration. This involves an understanding of **setuid/setgid** operations and the various effects they may have on your system and its level of security.

Third, it is assumed that you are using an **unmodified** version of suEXEC code. All code for suEXEC has been carefully scrutinized and tested by the developers as well as numerous beta testers. Every precaution has been taken to ensure a simple yet solidly safe base of code. Altering this code can cause unexpected problems and new security risks. It is **highly** recommended you not alter the suEXEC code unless you are well versed in the particulars of security programming and are willing to share your work with the Apache Group for consideration.

Fourth, and last, it has been the decision of the Apache Group to **NOT** make suEXEC part of the default installation of Apache. To this end, suEXEC configuration requires of the administrator careful attention to details. After due consideration has been given to the various settings for suEXEC, the administrator may install suEXEC through normal installation methods. The values for these settings need to be carefully determined and specified by the administrator to properly maintain system security during the use of suEXEC functionality. It is through this detailed process that the Apache Group hopes to limit suEXEC installation only to those who are careful and determined enough to use it.

Still with us? Yes? Good. Let's move on!

suEXEC Security Model

Before we begin configuring and installing suEXEC, we will first discuss the security model you are about to implement. By doing so, you may better understand what exactly is going on inside suEXEC and what precautions are taken to ensure your system's security.

suEXEC is based on a *setuid* "wrapper" program that is called by the main Apache web server. This wrapper is called when an HTTP request is made for a CGI or SSI program that the administrator has designated to run as a *userid* other than that of the main server. When such a request is made, Apache provides the suEXEC wrapper with the program's name and the user and group IDs under which the program is to execute.

The wrapper then employs the following process to determine success or failure – if any one of these conditions fail, the program logs the failure and exits with an error, otherwise it will continue:

1. **Is the user executing this wrapper a valid user of this system?**

This is to ensure that the user executing the wrapper is truly a user of the system.

2. Was the wrapper called with the proper number of arguments?

The wrapper will only execute if it is given the proper number of arguments. The proper argument format is known to the Apache web server. If the wrapper is not receiving the proper number of arguments, it is either being hacked, or there is something wrong with the suEXEC portion of your Apache binary.

3. Is this valid user allowed to run the wrapper?

Is this user the user allowed to run this wrapper? Only one user (the Apache user) is allowed to execute this program.

4. Does the target CGI or SSI program have an unsafe hierarchical reference?

Does the target CGI or SSI program's path contain a leading '/' or have a '..' backreference? These are not allowed; the target CGI/SSI program must reside within suEXEC's document root (see `--with-suexec-docroot=DIR` below).

5. Is the target user name valid?

Does the target user exist?

6. Is the target group name valid?

Does the target group exist?

7. Is the target user *NOT* superuser?

Presently, suEXEC does not allow `root` to execute CGI/SSI programs.

8. Is the target userid *ABOVE* the minimum ID number?

The minimum user ID number is specified during configuration. This allows you to set the lowest possible userid that will be allowed to execute CGI/SSI programs. This is useful to block out "system" accounts.

9. Is the target group *NOT* the superuser group?

Presently, suEXEC does not allow the `root` group to execute CGI/SSI programs.

10. Is the target groupid *ABOVE* the minimum ID number?

The minimum group ID number is specified during configuration. This allows you to set the lowest possible groupid that will be allowed to execute CGI/SSI programs. This is useful to block out "system" groups.

11. Can the wrapper successfully become the target user and group?

Here is where the program becomes the target user and group via `setuid` and `setgid` calls. The group access list is also initialized with all of the groups of which the user is a member.

12. Can we change directory to the one in which the target CGI/SSI program resides?

If it doesn't exist, it can't very well contain files. If we can't change directory to it, it might as well not exist.

13. Is the directory within the Apache webspace?

If the request is for a regular portion of the server, is the requested directory within suEXEC's document root? If the request is for a UserDir, is the requested directory within the directory configured as suEXEC's userdir (see suEXEC's configuration options)?

14. Is the directory *NOT* writable by anyone else?

We don't want to open up the directory to others; only the owner user may be able to alter this directories contents.

15. Does the target CGI/SSI program exist?

If it doesn't exist, it can't very well be executed.

16. Is the target CGI/SSI program *NOT* writable by anyone else?

We don't want to give anyone other than the owner the ability to change the CGI/SSI program.

17. Is the target CGI/SSI program *NOT* setuid or setgid?

We do not want to execute programs that will then change our UID/GID again.

18. Is the target user/group the same as the program's user/group?

Is the user the owner of the file?

19. Can we successfully clean the process environment to ensure safe operations?

suEXEC cleans the process' environment by establishing a safe execution PATH (defined during configuration), as well as only passing through those variables whose names are listed in the safe environment list (also created during configuration).

20. Can we successfully become the target CGI/SSI program and execute?

Here is where suEXEC ends and the target CGI/SSI program begins.

This is the standard operation of the suEXEC wrapper's security model. It is somewhat stringent and can impose new limitations and guidelines for CGI/SSI design, but it was developed carefully step-by-step with security in mind.

For more information as to how this security model can limit your possibilities in regards to server configuration, as well as what security risks can be avoided with a proper suEXEC setup, see the "Beware the Jabberwock" section of this document.

Configuring & Installing suEXEC

Here's where we begin the fun.

suEXEC configuration options

--enable-suexec This option enables the suEXEC feature which is never installed or activated by default. At least one **--with-suexec-xxxxxx** option has to be provided together with the **--enable-suexec** option to let APACI accept your request for using the suEXEC feature.

--with-suexec-bin=PATH The path to the `suexec` binary must be hard-coded in the server for security reasons. Use this option to override the default path. *e.g.* **--with-suexec-bin=/usr/bin/suexec**

--with-suexec-caller=UID The username (p. 591) under which Apache normally runs. This is the only user allowed to execute this program.

--with-suexec-userdir=DIR Define to be the subdirectory under users' home directories where suEXEC access should be allowed. All executables under this directory will be executable by suEXEC as the user so they should be "safe" programs. If you are using a "simple" UserDir directive (ie. one without a "*" in it) this should be set to the same value. suEXEC will not work properly in cases where the UserDir directive points to a location that is not the same as the user's home directory as referenced in the passwd file. Default value is "public_html".

If you have virtual hosts with a different UserDir for each, you will need to define them to all reside in one parent directory; then name that parent directory here. **If this is not defined properly, "~userdir" cgi requests will not work!**

--with-suexec-docroot=DIR Define as the DocumentRoot set for Apache. This will be the only hierarchy (aside from UserDirs) that can be used for suEXEC behavior. The default directory is the `--datadir` value with the suffix "/htdocs", *e.g.* if you configure with **"--datadir=/home/apache"** the directory **"/home/apache/htdocs"** is used as document root for the suEXEC wrapper.

- with-suexec-uidmin=UID** Define this as the lowest UID allowed to be a target user for suEXEC. For most systems, 500 or 100 is common. Default value is 100.
- with-suexec-gidmin=GID** Define this as the lowest GID allowed to be a target group for suEXEC. For most systems, 100 is common and therefore used as default value.
- with-suexec-logfile=FILE** This defines the filename to which all suEXEC transactions and errors are logged (useful for auditing and debugging purposes). By default the logfile is named "suexec_log" and located in your standard logfile directory (`--logfiledir`).
- with-suexec-safepath=PATH** Define a safe PATH environment to pass to CGI executables. Default value is `"/usr/local/bin:/usr/bin:/bin"`.

Compiling and installing the suEXEC wrapper

If you have enabled the suEXEC feature with the `--enable-suexec` option the `suexec` binary (together with Apache itself) is automatically built if you execute the `make` command.

After all components have been built you can execute the command `make install` to install them. The binary image `suexec` is installed in the directory defined by the `--sbindir` option. The default location is `"/usr/local/apache2/bin/suexec"`.

Please note that you need *root privileges* for the installation step. In order for the wrapper to set the user ID, it must be installed as owner `root` and must have the setuserid execution bit set for file modes.

Setting paranoid permissions

Although the suEXEC wrapper will check to ensure that its caller is the correct user as specified with the `--with-suexec-caller` configure option, there is always the possibility that a system or library call suEXEC uses before this check may be exploitable on your system. To counter this, and because it is best-practise in general, you should use filesystem permissions to ensure that only the group Apache runs as may execute suEXEC.

If for example, your web-server is configured to run as:

```
User www
Group webgroup
```

and `suexec` is installed at `"/usr/local/apache2/bin/suexec"`, you should run:

```
chgrp webgroup /usr/local/apache2/bin/suexec
chmod 4750 /usr/local/apache2/bin/suexec
```

This will ensure that only the group Apache runs as can even execute the suEXEC wrapper.

Enabling & Disabling suEXEC

Upon startup of Apache, it looks for the file `suexec` in the directory defined by the `--sbindir` option (default is `"/usr/local/apache/bin/suexec"`). If Apache finds a properly configured suEXEC wrapper, it will print the following message to the error log:

```
[notice] suEXEC mechanism enabled (wrapper: /path/to/suexec)
```

If you don't see this message at server startup, the server is most likely not finding the wrapper program where it expects it, or the executable is not installed *setuid root*.

If you want to enable the suEXEC mechanism for the first time and an Apache server is already running you must kill and restart Apache. Restarting it with a simple HUP or USR1 signal will not be enough.

If you want to disable suEXEC you should kill and restart Apache after you have removed the `suexec` file.

Using suEXEC

Requests for CGI programs will call the suEXEC wrapper only if they are for a virtual host containing a `SUEXECUSERGROUP` directive or if they are processed by `MOD_USERDIR`.

Virtual Hosts:

One way to use the suEXEC wrapper is through the `SUEXECUSERGROUP` directive in `VIRTUALHOST` definitions. By setting this directive to values different from the main server user ID, all requests for CGI resources will be executed as the *User* and *Group* defined for that `<VIRTUALHOST>`. If this directive is not specified for a `<VIRTUALHOST>` then the main server userid is assumed.

User directories:

Requests that are processed by `MOD_USERDIR` will call the suEXEC wrapper to execute CGI programs under the userid of the requested user directory. The only requirement needed for this feature to work is for CGI execution to be enabled for the user and that the script must meet the scrutiny of the security checks above. See also the `--with-suexec-userdir` compile time option.

Debugging suEXEC

The suEXEC wrapper will write log information to the file defined with the `--with-suexec-logfile` option as indicated above. If you feel you have configured and installed the wrapper properly, have a look at this log and the `error_log` for the server to see where you may have gone astray.

Beware the Jabberwock: Warnings & Examples

NOTE! This section may not be complete. For the latest revision of this section of the documentation, see the Apache Group's Online Documentation¹⁹ version.

There are a few points of interest regarding the wrapper that can cause limitations on server setup. Please review these before submitting any "bugs" regarding suEXEC.

- **suEXEC Points Of Interest**
- Hierarchy limitations

For security and efficiency reasons, all suEXEC requests must remain within either a top-level document root for virtual host requests, or one top-level personal document root for userdir requests. For example, if you have four VirtualHosts configured, you would need to structure all of your VHosts' document roots off of one main Apache document hierarchy to take advantage of suEXEC for VirtualHosts. (Example forthcoming.)

- suEXEC's PATH environment variable

This can be a dangerous thing to change. Make certain every path you include in this define is a **trusted** directory. You don't want to open people up to having someone from across the world running a trojan horse on them.

- Altering the suEXEC code

Again, this can cause **Big Trouble** if you try this without knowing what you are doing. Stay away from it if at all possible.

¹⁹<http://httpd.apache.org/docs/2.0/suexec.html>

2.19 Apache Performance Tuning

Apache 2.x is a general-purpose webserver, designed to provide a balance of flexibility, portability, and performance. Although it has not been designed specifically to set benchmark records, Apache 2.x is capable of high performance in many real-world situations.

Compared to Apache 1.3, release 2.x contains many additional optimizations to increase throughput and scalability. Most of these improvements are enabled by default. However, there are compile-time and run-time configuration choices that can significantly affect performance. This document describes the options that a server administrator can configure to tune the performance of an Apache 2.x installation. Some of these configuration options enable the httpd to better take advantage of the capabilities of the hardware and OS, while others allow the administrator to trade functionality for speed.

Hardware and Operating System Issues

The single biggest hardware issue affecting webserver performance is RAM. A webserver should never ever have to swap, as swapping increases the latency of each request beyond a point that users consider "fast enough". This causes users to hit stop and reload, further increasing the load. You can, and should, control the `MAXCLIENTS` setting so that your server does not spawn so many children it starts swapping. This procedure for doing this is simple: determine the size of your average Apache process, by looking at your process list via a tool such as `top`, and divide this into your total available memory, leaving some room for other processes.

Beyond that the rest is mundane: get a fast enough CPU, a fast enough network card, and fast enough disks, where "fast enough" is something that needs to be determined by experimentation.

Operating system choice is largely a matter of local concerns. But some guidelines that have proven generally useful are:

- Run the latest stable release and patchlevel of the operating system that you choose. Many OS suppliers have introduced significant performance improvements to their TCP stacks and thread libraries in recent years.
- If your OS supports a `sendfile(2)` system call, make sure you install the release and/or patches needed to enable it. (With Linux, for example, this means using Linux 2.4 or later. For early releases of Solaris 8, you may need to apply a patch.) On systems where it is available, `sendfile` enables Apache 2 to deliver static content faster and with lower CPU utilization.

Run-Time Configuration Issues

Related Modules	Related Directives
<code>MOD_DIR</code>	<code>ALLOWOVERRIDE</code>
<code>MPM_COMMON</code>	<code>DIRECTORYINDEX</code>
<code>MOD_STATUS</code>	<code>HOSTNAMELOOKUPS</code>
	<code>ENABLEMMAP</code>
	<code>ENABLESENDFILE</code>
	<code>KEEPALIVETIMEOUT</code>
	<code>MAXSPARESERVERS</code>
	<code>MINSPARESERVERS</code>
	<code>OPTIONS</code>
	<code>STARTSERVERS</code>

HostnameLookups and other DNS considerations

Prior to Apache 1.3, `HOSTNAMELOOKUPS` defaulted to `On`. This adds latency to every request because it requires a DNS lookup to complete before the request is finished. In Apache 1.3 this setting defaults to `Off`. If you need to have addresses in your log files resolved to hostnames, use the `logresolve` program that comes with Apache, or one of the numerous log reporting packages which are available.

It is recommended that you do this sort of postprocessing of your log files on some machine other than the production web server machine, in order that this activity not adversely affect server performance.

If you use any `ALLOW` from domain or `DENY` from domain directives (i.e., using a hostname, or a domain name, rather than an IP address) then you will pay for two DNS lookups (a reverse, followed by a forward lookup to make sure that the reverse is not being spoofed). For best performance, therefore, use IP addresses, rather than names, when using these directives, if possible.

Note that it's possible to scope the directives, such as within a `<Location /server-status>` section. In this case the DNS lookups are only performed on requests matching the criteria. Here's an example which disables lookups except for `.html` and `.cgi` files:

```
HostnameLookups off
<Files ~ "\.(html|cgi)$">
    HostnameLookups on
</Files>
```

But even still, if you just need DNS names in some CGIs you could consider doing the `gethostbyname` call in the specific CGIs that need it.

FollowSymLinks and SymLinksIfOwnerMatch

Wherever in your URL-space you do not have an `Options FollowSymLinks`, or you do have an `Options SymLinksIfOwnerMatch` Apache will have to issue extra system calls to check up on symlinks. One extra call per filename component. For example, if you had:

```
DocumentRoot /www/htdocs
<Directory />
    Options SymLinksIfOwnerMatch
</Directory>
```

and a request is made for the URI `/index.html`. Then Apache will perform `lstat(2)` on `/www/`, `/www/htdocs`, and `/www/htdocs/index.html`. The results of these `lstats` are never cached, so they will occur on every single request. If you really desire the symlinks security checking you can do something like this:

```
DocumentRoot /www/htdocs
<Directory />
    Options FollowSymLinks
</Directory>
<Directory /www/htdocs>
    Options -FollowSymLinks +SymLinksIfOwnerMatch
</Directory>
```

This at least avoids the extra checks for the `DOCUMENTROOT` path. Note that you'll need to add similar sections if you have any `ALIAS` or `REWRITERULE` paths outside of your document root. For highest performance, and no symlink protection, set `FollowSymLinks` everywhere, and never set `SymLinksIfOwnerMatch`.

AllowOverride

Wherever in your URL-space you allow overrides (typically `.htaccess` files) Apache will attempt to open `.htaccess` for each filename component. For example,

```
DocumentRoot /www/htdocs
<Directory />
    AllowOverride all
</Directory>
```

and a request is made for the URI `/index.html`. Then Apache will attempt to open `/.htaccess`, `/www/.htaccess`, and `/www/htdocs/.htaccess`. The solutions are similar to the previous case of `Options FollowSymLinks`. For highest performance use `AllowOverride None` everywhere in your filesystem.

Negotiation

If at all possible, avoid content-negotiation if you're really interested in every last ounce of performance. In practice the benefits of negotiation outweigh the performance penalties. There's one case where you can speed up the server. Instead of using a wildcard such as:

```
DirectoryIndex index
```

Use a complete list of options:

```
DirectoryIndex index.cgi index.pl index.shtml index.html
```

where you list the most common choice first.

Also note that explicitly creating a `type-map` file provides better performance than using `MultiViews`, as the necessary information can be determined by reading this single file, rather than having to scan the directory for files.

If your site needs content negotiation consider using `type-map` files, rather than the `Options MultiViews` directive to accomplish the negotiation. See the Content Negotiation (p. 47) documentation for a full discussion of the methods of negotiation, and instructions for creating `type-map` files.

Memory-mapping

In situations where Apache 2.x needs to look at the contents of a file being delivered—for example, when doing server-side-include processing—it normally memory-maps the file if the OS supports some form of `mmap(2)`.

On some platforms, this memory-mapping improves performance. However, there are cases where memory-mapping can hurt the performance or even the stability of the `httpd`:

- On some operating systems, `mmap` does not scale as well as `read(2)` when the number of CPUs increases. On multiprocessor Solaris servers, for example, Apache 2.x sometimes delivers server-parsed files faster when `mmap` is disabled.
- If you memory-map a file located on an NFS-mounted filesystem and a process on another NFS client machine deletes or truncates the file, your process may get a bus error the next time it tries to access the mapped file content.

For installations where either of these factors applies, you should use `EnableMMAP off` to disable the memory-mapping of delivered files. (Note: This directive can be overridden on a per-directory basis.)

Sendfile

In situations where Apache 2.x can ignore the contents of the file to be delivered – for example, when serving static file content – it normally uses the kernel sendfile support the file if the OS supports the `sendfile(2)` operation.

On most platforms, using sendfile improves performance by eliminating separate read and send mechanics. However, there are cases where using sendfile can harm the stability of the `httpd`:

- Some platforms may have broken sendfile support that the build system did not detect, especially if the binaries were built on another box and moved to such a machine with broken sendfile support.
- With an NFS-mounted files, the kernel may be unable to reliably serve the network file through it's own cache.

For installations where either of these factors applies, you should use `EnableSendfile off` to disable sendfile delivery of file contents. (Note: This directive can be overridden on a per-directory basis.)

Process Creation

Prior to Apache 1.3 the `MINSPARESERVERS`, `MAXSPARESERVERS`, and `STARTSERVERS` settings all had drastic effects on benchmark results. In particular, Apache required a "ramp-up" period in order to reach a number of children sufficient to serve the load being applied. After the initial spawning of `STARTSERVERS` children, only one child per second would be created to satisfy the `MINSPARESERVERS` setting. So a server being accessed by 100 simultaneous clients, using the default `STARTSERVERS` of 5 would take on the order 95 seconds to spawn enough children to handle the load. This works fine in practice on real-life servers, because they aren't restarted frequently. But does really poorly on benchmarks which might only run for ten minutes.

The one-per-second rule was implemented in an effort to avoid swamping the machine with the startup of new children. If the machine is busy spawning children it can't service requests. But it has such a drastic effect on the perceived performance of Apache that it had to be replaced. As of Apache 1.3, the code will relax the one-per-second rule. It will spawn one, wait a second, then spawn two, wait a second, then spawn four, and it will continue exponentially until it is spawning 32 children per second. It will stop whenever it satisfies the `MINSPARESERVERS` setting.

This appears to be responsive enough that it's almost unnecessary to twiddle the `MINSPARESERVERS`, `MAXSPARESERVERS` and `STARTSERVERS` knobs. When more than 4 children are spawned per second, a message will be emitted to the `ERRORLOG`. If you see a lot of these errors then consider tuning these settings. Use the `MOD_STATUS` output as a guide.

Related to process creation is process death induced by the `MAXREQUESTSPERCHILD` setting. By default this is 0, which means that there is no limit to the number of requests handled per child. If your configuration currently has this set to some very low number, such as 30, you may want to bump this up significantly. If you are running SunOS or an old version of Solaris, limit this to 10000 or so because of memory leaks.

When keep-alives are in use, children will be kept busy doing nothing waiting for more requests on the already open connection. The default `KEEPALIVETIMEOUT` of 15 seconds attempts to minimize this effect. The tradeoff here is between network bandwidth and server resources. In no event should you raise this above about 60 seconds, as most of the benefits are lost²⁰.

Compile-Time Configuration Issues

Choosing an MPM

Apache 2.x supports pluggable concurrency models, called Multi-Processing Modules (p. 59) (MPMs). When building Apache, you must choose an MPM to use. There are platform-specific MPMs for some platforms: `BEOS`,

²⁰<http://www.research.digital.com/wrl/techreports/abstracts/95.4.html>

[MPM_NETWORK](#), [MPM_OS2](#), and [MPM_WINNT](#). For general Unix-type systems, there are several MPMs from which to choose. The choice of MPM can affect the speed and scalability of the httpd:

- The [WORKER](#) MPM uses multiple child processes with many threads each. Each thread handles one connection at a time. Worker generally is a good choice for high-traffic servers because it has a smaller memory footprint than the prefork MPM.
- The [PREFORK](#) MPM uses multiple child processes with one thread each. Each process handles one connection at a time. On many systems, prefork is comparable in speed to worker, but it uses more memory. Prefork's threadless design has advantages over worker in some situations: it can be used with non-thread-safe third-party modules, and it is easier to debug on platforms with poor thread debugging support.

For more information on these and other MPMs, please see the MPM documentation (p. 59).

Modules

Since memory usage is such an important consideration in performance, you should attempt to eliminate modules that you are not actually using. If you have built the modules as DSOs (p. 44), eliminating modules is a simple matter of commenting out the associated [LOADMODULE](#) directive for that module. This allows you to experiment with removing modules, and seeing if your site still functions in their absence.

If, on the other hand, you have modules statically linked into your Apache binary, you will need to recompile Apache in order to remove unwanted modules.

An associated question that arises here is, of course, what modules you need, and which ones you don't. The answer here will, of course, vary from one web site to another. However, the *minimal* list of modules which you can get by with tends to include [MOD_MIME](#), [MOD_DIR](#), and [MOD_LOG_CONFIG](#). `mod_log_config` is, of course, optional, as you can run a web site without log files. This is, however, not recommended.

Atomic Operations

Some modules, such as [MOD_CACHE](#) and recent development builds of the worker MPM, use APR's atomic API. This API provides atomic operations that can be used for lightweight thread synchronization.

By default, APR implements these operations using the most efficient mechanism available on each target OS/CPU platform. Many modern CPUs, for example, have an instruction that does an atomic compare-and-swap (CAS) operation in hardware. On some platforms, however, APR defaults to a slower, mutex-based implementation of the atomic API in order to ensure compatibility with older CPU models that lack such instructions. If you are building Apache for one of these platforms, and you plan to run only on newer CPUs, you can select a faster atomic implementation at build time by configuring Apache with the `--enable-nonportable-atomics` option:

```
./buildconf
./configure --with-mpm=worker --enable-nonportable-atomics=yes
```

The `--enable-nonportable-atomics` option is relevant for the following platforms:

- Solaris on SPARC
By default, APR uses mutex-based atomics on Solaris/SPARC. If you configure with `--enable-nonportable-atomics`, however, APR generates code that uses a SPARC v8plus opcode for fast hardware compare-and-swap. If you configure Apache with this option, the atomic operations will be more efficient (allowing for lower CPU utilization and higher concurrency), but the resulting executable will run only on UltraSPARC chips.

- Linux on x86

By default, APR uses mutex-based atomics on Linux. If you configure with `--enable-nonportable-atomics`, however, APR generates code that uses a 486 opcode for fast hardware compare-and-swap. This will result in more efficient atomic operations, but the resulting executable will run only on 486 and later chips (and not on 386).

`mod_status` and `ExtendedStatus On`

If you include `MOD_STATUS` and you also set `ExtendedStatus On` when building and running Apache, then on every request Apache will perform two calls to `gettimeofday(2)` (or `times(2)` depending on your operating system), and (pre-1.3) several extra calls to `time(2)`. This is all done so that the status report contains timing indications. For highest performance, set `ExtendedStatus off` (which is the default).

accept Serialization - multiple sockets



Warning:

This section has not been fully updated to take into account changes made in the 2.x version of the Apache HTTP Server. Some of the information may still be relevant, but please use it with care.

This discusses a shortcoming in the Unix socket API. Suppose your web server uses multiple `LISTEN` statements to listen on either multiple ports or multiple addresses. In order to test each socket to see if a connection is ready Apache uses `select(2)`. `select(2)` indicates that a socket has *zero* or *at least one* connection waiting on it. Apache's model includes multiple children, and all the idle ones test for new connections at the same time. A naive implementation looks something like this (these examples do not match the code, they're contrived for pedagogical purposes):

```
for (;;) {
    for (;;) {
        fd_set accept_fds;
        FD_ZERO (&accept_fds);
        for (i = first_socket; i <= last_socket; ++i) {
            FD_SET (i, &accept_fds);
        }
        rc = select (last_socket+1, &accept_fds, NULL, NULL, NULL);
        if (rc < 1) continue;
        new_connection = -1;
        for (i = first_socket; i <= last_socket; ++i) {
            if (FD_ISSET (i, &accept_fds)) {
                new_connection = accept (i, NULL, NULL);
                if (new_connection != -1) break;
            }
        }
        if (new_connection != -1) break;
    }
    process the new_connection;
}
```

But this naive implementation has a serious starvation problem. Recall that multiple children execute this loop at the same time, and so multiple children will block at `select` when they are in between requests. All those blocked

children will awaken and return from `select` when a single request appears on any socket (the number of children which awaken varies depending on the operating system and timing issues). They will all then fall down into the loop and try to `accept` the connection. But only one will succeed (assuming there's still only one connection ready), the rest will be *blocked* in `accept`. This effectively locks those children into serving requests from that one socket and no other sockets, and they'll be stuck there until enough new requests appear on that socket to wake them all up. This starvation problem was first documented in PR#467²¹. There are at least two solutions.

One solution is to make the sockets non-blocking. In this case the `accept` won't block the children, and they will be allowed to continue immediately. But this wastes CPU time. Suppose you have ten idle children in `select`, and one connection arrives. Then nine of those children will wake up, try to `accept` the connection, fail, and loop back into `select`, accomplishing nothing. Meanwhile none of those children are servicing requests that occurred on other sockets until they get back up to the `select` again. Overall this solution does not seem very fruitful unless you have as many idle CPUs (in a multiprocessor box) as you have idle children, not a very likely situation.

Another solution, the one used by Apache, is to serialize entry into the inner loop. The loop looks like this (differences highlighted):

```
for (;;) {
    accept_mutex_on ();
    for (;;) {
        fd_set accept_fds;
        FD_ZERO (&accept_fds);
        for (i = first_socket; i <= last_socket; ++i) {
            FD_SET (i, &accept_fds);
        }
        rc = select (last_socket+1, &accept_fds, NULL, NULL, NULL);
        if (rc < 1) continue;
        new_connection = -1;
        for (i = first_socket; i <= last_socket; ++i) {
            if (FD_ISSET (i, &accept_fds)) {
                new_connection = accept (i, NULL, NULL);
                if (new_connection != -1) break;
            }
        }
        if (new_connection != -1) break;
    }
    accept_mutex_off ();
    process the new_connection;
}
```

The functions `accept_mutex_on` and `accept_mutex_off` implement a mutual exclusion semaphore. Only one child can have the mutex at any time. There are several choices for implementing these mutexes. The choice is defined in `src/conf.h` (pre-1.3) or `src/include/ap_config.h` (1.3 or later). Some architectures do not have any locking choice made, on these architectures it is unsafe to use multiple `LISTEN` directives.

The directive `ACCEPTMUTEX` can be used to change the selected mutex implementation at run-time.

AcceptMutex flock This method uses the `flock(2)` system call to lock a lock file (located by the `LOCKFILE` directive).

AcceptMutex fcntl This method uses the `fcntl(2)` system call to lock a lock file (located by the `LOCKFILE` directive).

²¹<http://bugs.apache.org/index/full/467>

AcceptMutex sysvsem (1.3 or later) This method uses SysV-style semaphores to implement the mutex. Unfortunately SysV-style semaphores have some bad side-effects. One is that it's possible Apache will die without cleaning up the semaphore (see the `ipcs(8)` man page). The other is that the semaphore API allows for a denial of service attack by any CGIs running under the same uid as the webserver (*i.e.*, all CGIs, unless you use something like `suexec` or `cgiwrapper`). For these reasons this method is not used on any architecture except IRIX (where the previous two are prohibitively expensive on most IRIX boxes).

AcceptMutex pthread (1.3 or later) This method uses POSIX mutexes and should work on any architecture implementing the full POSIX threads specification, however appears to only work on Solaris (2.5 or later), and even then only in certain configurations. If you experiment with this you should watch out for your server hanging and not responding. Static content only servers may work just fine.

AcceptMutex posixsem (2.0 or later) This method uses POSIX semaphores. The semaphore ownership is not recovered if a thread in the process holding the mutex segfaults, resulting in a hang of the web server.

If your system has another method of serialization which isn't in the above list then it may be worthwhile adding code for it to APR.

Another solution that has been considered but never implemented is to partially serialize the loop – that is, let in a certain number of processes. This would only be of interest on multiprocessor boxes where it's possible multiple children could run simultaneously, and the serialization actually doesn't take advantage of the full bandwidth. This is a possible area of future investigation, but priority remains low because highly parallel web servers are not the norm.

Ideally you should run servers without multiple `LISTEN` statements if you want the highest performance. But read on.

accept Serialization - single socket

The above is fine and dandy for multiple socket servers, but what about single socket servers? In theory they shouldn't experience any of these same problems because all children can just block in `accept(2)` until a connection arrives, and no starvation results. In practice this hides almost the same "spinning" behaviour discussed above in the non-blocking solution. The way that most TCP stacks are implemented, the kernel actually wakes up all processes blocked in `accept` when a single connection arrives. One of those processes gets the connection and returns to user-space, the rest spin in the kernel and go back to sleep when they discover there's no connection for them. This spinning is hidden from the user-land code, but it's there nonetheless. This can result in the same load-spiking wasteful behaviour that a non-blocking solution to the multiple sockets case can.

For this reason we have found that many architectures behave more "nicely" if we serialize even the single socket case. So this is actually the default in almost all cases. Crude experiments under Linux (2.0.30 on a dual Pentium pro 166 w/128Mb RAM) have shown that the serialization of the single socket case causes less than a 3% decrease in requests per second over unserialized single-socket. But unserialized single-socket showed an extra 100ms latency on each request. This latency is probably a wash on long haul lines, and only an issue on LANs. If you want to override the single socket serialization you can define `SINGLE_LISTEN_UNSERIALIZED_ACCEPT` and then single-socket servers will not serialize at all.

Lingering Close

As discussed in draft-ietf-http-connection-00.txt²² section 8, in order for an HTTP server to **reliably** implement the protocol it needs to shutdown each direction of the communication independently (recall that a TCP connection is bi-directional, each half is independent of the other). This fact is often overlooked by other servers, but is correctly implemented in Apache as of 1.2.

When this feature was added to Apache it caused a flurry of problems on various versions of Unix because of a shortsightedness. The TCP specification does not state that the `FIN_WAIT_2` state has a timeout, but it doesn't prohibit

²²<http://www.ics.uci.edu/pub/ietf/http/draft-ietf-http-connection-00.txt>

it. On systems without the timeout, Apache 1.2 induces many sockets stuck forever in the `FIN_WAIT_2` state. In many cases this can be avoided by simply upgrading to the latest TCP/IP patches supplied by the vendor. In cases where the vendor has never released patches (*i.e.*, SunOS4 – although folks with a source license can patch it themselves) we have decided to disable this feature.

There are two ways of accomplishing this. One is the socket option `SO_LINGER`. But as fate would have it, this has never been implemented properly in most TCP/IP stacks. Even on those stacks with a proper implementation (*i.e.*, Linux 2.0.31) this method proves to be more expensive (cputime) than the next solution.

For the most part, Apache implements this in a function called `lingering_close` (in `http_main.c`). The function looks roughly like this:

```
void lingering_close (int s)
{
    char junk_buffer[2048];
    /* shutdown the sending side */
    shutdown (s, 1);
    signal (SIGALRM, lingering_death);
    alarm (30);
    for (;;) {
        select (s for reading, 2 second timeout);
        if (error) break;
        if (s is ready for reading) {
            if (read (s, junk_buffer, sizeof (junk_buffer)) <= 0) {
                break;
            }
            /* just toss away whatever is here */
        }
    }
    close (s);
}
```

This naturally adds some expense at the end of a connection, but it is required for a reliable implementation. As HTTP/1.1 becomes more prevalent, and all connections are persistent, this expense will be amortized over more requests. If you want to play with fire and disable this feature you can define `NO_LINGCLOSE`, but this is not recommended at all. In particular, as HTTP/1.1 pipelined persistent connections come into use `lingering_close` is an absolute necessity (and pipelined connections are faster²³, so you want to support them).

Scoreboard File

Apache's parent and children communicate with each other through something called the scoreboard. Ideally this should be implemented in shared memory. For those operating systems that we either have access to, or have been given detailed ports for, it typically is implemented using shared memory. The rest default to using an on-disk file. The on-disk file is not only slow, but it is unreliable (and less featured). Peruse the `src/main/conf.h` file for your architecture and look for either `USE_MMAP_SCOREBOARD` or `USE_SHMGET_SCOREBOARD`. Defining one of those two (as well as their companions `HAVE_MMAP` and `HAVE_SHMGET` respectively) enables the supplied shared memory code. If your system has another type of shared memory, edit the file `src/main/http_main.c` and add the hooks necessary to use it in Apache. (Send us back a patch too please.)

→ Historical note: The Linux port of Apache didn't start to use shared memory until version 1.2 of Apache. This oversight resulted in really poor and unreliable behaviour of earlier versions of Apache on Linux.

²³<http://www.w3.org/Protocols/HTTP/Performance/Pipeline.html>

DYNAMIC_MODULE_LIMIT

If you have no intention of using dynamically loaded modules (you probably don't if you're reading this and tuning your server for every last ounce of performance) then you should add `-DDYNAMIC_MODULE_LIMIT=0` when building your server. This will save RAM that's allocated only for supporting dynamically loaded modules.

Appendix: Detailed Analysis of a Trace

Here is a system call trace of Apache 2.0.38 with the worker MPM on Solaris 8. This trace was collected using:

```
truss -l -p httpd_child_pid.
```

The `-l` option tells `truss` to log the ID of the LWP (lightweight process—Solaris's form of kernel-level thread) that invokes each system call.

Other systems may have different system call tracing utilities such as `strace`, `ktrace`, or `par`. They all produce similar output.

In this trace, a client has requested a 10KB static file from the `httpd`. Traces of non-static requests or requests with content negotiation look wildly different (and quite ugly in some cases).

```
/67:  accept(3, 0x00200BEC, 0x00200C0C, 1) (sleeping...)
/67:  accept(3, 0x00200BEC, 0x00200C0C, 1)                = 9
```

In this trace, the listener thread is running within LWP #67.

⇒ Note the lack of `accept(2)` serialization. On this particular platform, the worker MPM uses an unserialized `accept` by default unless it is listening on multiple ports.

```
/65:  lwp_park(0x00000000, 0)                               = 0
/67:  lwp_unpark(65, 1)                                    = 0
```

Upon accepting the connection, the listener thread wakes up a worker thread to do the request processing. In this trace, the worker thread that handles the request is mapped to LWP #65.

```
/65:  getsockname(9, 0x00200BA4, 0x00200BC4, 1)           = 0
```

In order to implement virtual hosts, Apache needs to know the local socket address used to accept the connection. It is possible to eliminate this call in many situations (such as when there are no virtual hosts, or when `LISTEN` directives are used which do not have wildcard addresses). But no effort has yet been made to do these optimizations.

```
/65:  brk(0x002170E8)                                     = 0
/65:  brk(0x002190E8)                                     = 0
```

The `brk(2)` calls allocate memory from the heap. It is rare to see these in a system call trace, because the `httpd` uses custom memory allocators (`apr_pool` and `apr_bucket_alloc`) for most request processing. In this trace, the `httpd` has just been started, so it must call `malloc(3)` to get the blocks of raw memory with which to create the custom memory allocators.

```

/65:  fcntl(9, F_GETFL, 0x00000000)          = 2
/65:  fstat64(9, 0xFAF7B818)                = 0
/65:  getsockopt(9, 65535, 8192, 0xFAF7B918, 0xFAF7B910, 2190656) = 0
/65:  fstat64(9, 0xFAF7B818)                = 0
/65:  getsockopt(9, 65535, 8192, 0xFAF7B918, 0xFAF7B914, 2190656) = 0
/65:  setsockopt(9, 65535, 8192, 0xFAF7B918, 4, 2190656) = 0
/65:  fcntl(9, F_SETFL, 0x00000082)          = 0

```

Next, the worker thread puts the connection to the client (file descriptor 9) in non-blocking mode. The `setsockopt(2)` and `getsockopt(2)` calls are a side-effect of how Solaris's `libc` handles `fcntl(2)` on sockets.

```

/65:  read(9, " G E T   / 1 0 k . h t m" .., 8000)      = 97

```

The worker thread reads the request from the client.

```

/65:  stat("/var/httpd/apache/httpd-8999/htdocs/10k.html", 0xFAF7B978) = 0
/65:  open("/var/httpd/apache/httpd-8999/htdocs/10k.html", O_RDONLY) = 10

```

This `httpd` has been configured with `Options FollowSymLinks AllowOverride None`. Thus it doesn't need to `lstat(2)` each directory in the path leading up to the requested file, nor check for `.htaccess` files. It simply calls `stat(2)` to verify that the file: 1) exists, and 2) is a regular file, not a directory.

```

/65:  sendfilev(0, 9, 0x00200F90, 2, 0xFAF7B53C)          = 10269

```

In this example, the `httpd` is able to send the HTTP response header and the requested file with a single `sendfilev(2)` system call. `Sendfile` semantics vary among operating systems. On some other systems, it is necessary to do a `write(2)` or `writenv(2)` call to send the headers before calling `sendfile(2)`.

```

/65:  write(4, " 1 2 7 . 0 . 0 . 1   -   ".., 78)          = 78

```

This `write(2)` call records the request in the access log. Note that one thing missing from this trace is a `time(2)` call. Unlike Apache 1.3, Apache 2.x uses `gettimeofday(3)` to look up the time. On some operating systems, like Linux or Solaris, `gettimeofday` has an optimized implementation that doesn't require as much overhead as a typical system call.

```

/65:  shutdown(9, 1, 1)                                  = 0
/65:  poll(0xFAF7B980, 1, 2000)                          = 1
/65:  read(9, 0xFAF7BC20, 512)                            = 0
/65:  close(9)                                             = 0

```

The worker thread does a lingering close of the connection.

```

/65:  close(10)                                           = 0
/65:  lwp_park(0x00000000, 0)                            (sleeping...)

```

Finally the worker thread closes the file that it has just delivered and blocks until the listener assigns it another connection.

```
/67:    accept(3, 0x001FEB74, 0x001FEB94, 1) (sleeping...)
```

Meanwhile, the listener thread is able to accept another connection as soon as it has dispatched this connection to a worker thread (subject to some flow-control logic in the worker MPM that throttles the listener if all the available workers are busy). Though it isn't apparent from this trace, the next `accept(2)` can (and usually does, under high load conditions) occur in parallel with the worker thread's handling of the just-accepted connection.

2.20 URL Rewriting Guide

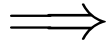

Originally written by
Ralf S. Engelschall <rse@apache.org>
December 1997

This document supplements the [MOD_REWRITE](#) reference documentation (p. 521) . It describes how one can use Apache's [MOD_REWRITE](#) to solve typical URL-based problems with which webmasters are commonly confronted. We give detailed descriptions on how to solve each problem by configuring URL rewriting rulesets.

Introduction to `mod_rewrite`

The Apache module [MOD_REWRITE](#) is a killer one, i.e. it is a really sophisticated module which provides a powerful way to do URL manipulations. With it you can do nearly all types of URL manipulations you ever dreamed about. The price you have to pay is to accept complexity, because [MOD_REWRITE](#)'s major drawback is that it is not easy to understand and use for the beginner. And even Apache experts sometimes discover new aspects where [MOD_REWRITE](#) can help.

In other words: With [MOD_REWRITE](#) you either shoot yourself in the foot the first time and never use it again or love it for the rest of your life because of its power. This paper tries to give you a few initial success events to avoid the first case by presenting already invented solutions to you.

Practical Solutions

Here come a lot of practical solutions I've either invented myself or collected from other people's solutions in the past. Feel free to learn the black magic of URL rewriting from these examples.



ATTENTION: Depending on your server-configuration it can be necessary to slightly change the examples for your situation, e.g. adding the `[PT]` flag when additionally using [MOD_ALIAS](#) and [MOD_USERDIR](#), etc. Or rewriting a ruleset to fit in `.htaccess` context instead of per-server context. Always try to understand what a particular ruleset really does before you use it. It avoid problems.

URL Layout

Canonical URLs

Description: On some webservers there are more than one URL for a resource. Usually there are canonical URLs (which should be actually used and distributed) and those which are just shortcuts, internal ones, etc. Independent of which URL the user supplied with the request he should finally see the canonical one only.

Solution: We do an external HTTP redirect for all non-canonical URLs to fix them in the location view of the Browser and for all subsequent requests. In the example ruleset below we replace `/~user` by the canonical `/u/user` and fix a missing trailing slash for `/u/user`.

```
RewriteRule  ^/~ ([^/]+)/? (.*)    /u/$1/$2    [R]
RewriteRule  ^/([uqe])/([~/]+)$   /$1/$2/    [R]
```

Canonical Hostnames

Description: The goal of this rule is to force the use of a particular hostname, in preference to other hostnames which may be used to reach the same site. For example, if you wish to force the use of **www.example.com** instead of **example.com**, you might use a variant of the following recipe.

```

# For sites running on a port other than 80
RewriteCond %{HTTP_HOST}    !^www\.example\.com [NC]
RewriteCond %{HTTP_HOST}    !^$
RewriteCond %{SERVER_PORT}  !^80$
Solution: RewriteRule ^/(.*)      http://www.example.com:%{SERVER_PORT}/$1 [L,R]

# And for a site running on port 80
RewriteCond %{HTTP_HOST}    !^www\.example\.com [NC]
RewriteCond %{HTTP_HOST}    !^$
RewriteRule ^/(.*)          http://www.example.com/$1 [L,R]

```

Moved DocumentRoot

Description: Usually the **DOCUMENTROOT** of the webserver directly relates to the URL `"/`. But often this data is not really of top-level priority, it is perhaps just one entity of a lot of data pools. For instance at our Intranet sites there are `/e/www/` (the homepage for WWW), `/e/sww/` (the homepage for the Intranet) etc. Now because the data of the **DOCUMENTROOT** stays at `/e/www/` we had to make sure that all inlined images and other stuff inside this data pool work for subsequent requests.

Solution: We redirect the URL `/` to `/e/www/`:

```

RewriteEngine on
RewriteRule    ^/$    /e/www/    [R]

```

Note that this can also be handled using the **REDIRECTMATCH** directive:

```

RedirectMatch ^/$ http://example.com/e/www/

```

Trailing Slash Problem

Description: Every webmaster can sing a song about the problem of the trailing slash on URLs referencing directories. If they are missing, the server dumps an error, because if you say `/~quux/foo` instead of `/~quux/foo/` then the server searches for a *file* named `foo`. And because this file is a directory it complains. Actually it tries to fix it itself in most of the cases, but sometimes this mechanism need to be emulated by you. For instance after you have done a lot of complicated URL rewritings to CGI scripts etc.

Solution: The solution to this subtle problem is to let the server add the trailing slash automatically. To do this correctly we have to use an external redirect, so the browser correctly requests subsequent images etc. If we only did a internal rewrite, this would only work for the directory page, but would go wrong when any images are included into this page with relative URLs, because the browser would request an in-lined object. For instance, a request for `image.gif` in `/~quux/foo/index.html` would become `/~quux/image.gif` without the external redirect!

So, to do this trick we write:

```

RewriteEngine on
RewriteBase /~quux/
RewriteRule ^foo$ foo/ [R]

```

The crazy and lazy can even do the following in the top-level `.htaccess` file of their homedir. But notice that this creates some processing overhead.

```

RewriteEngine on
RewriteBase /~quux/
RewriteCond %{REQUEST_FILENAME} -d
RewriteRule ^(.+[^/])$ $1/ [R]

```

Webcluster through Homogeneous URL Layout

Description: We want to create a homogeneous and consistent URL layout over all WWW servers on a Intranet webcluster, i.e. all URLs (per definition server local and thus server dependent!) become actually server *independent*! What we want is to give the WWW namespace a consistent server-independent layout: no URL should have to include any physically correct target server. The cluster itself should drive us automatically to the physical target host.

Solution: First, the knowledge of the target servers come from (distributed) external maps which contain information where our users, groups and entities stay. They have the form

```

user1  server_of_user1
user2  server_of_user2
:      :

```

We put them into files `map.xxx-to-host`. Second we need to instruct all servers to redirect URLs of the forms

```

/u/user/anypath
/g/group/anypath
/e/entity/anypath

```

to

```

http://physical-host/u/user/anypath
http://physical-host/g/group/anypath
http://physical-host/e/entity/anypath

```

when the URL is not locally valid to a server. The following ruleset does this for us by the help of the map files (assuming that `server0` is a default server which will be used if a user has no entry in the map):

```

RewriteEngine on

RewriteMap      user-to-host      txt:/path/to/map.user-to-host
RewriteMap      group-to-host     txt:/path/to/map.group-to-host
RewriteMap      entity-to-host    txt:/path/to/map.entity-to-host

RewriteRule     ^/u/([^/]+)/?(.*) http://${user-to-host:$1|server0}/u/$1/$2
RewriteRule     ^/g/([^/]+)/?(.*) http://${group-to-host:$1|server0}/g/$1/$2
RewriteRule     ^/e/([^/]+)/?(.*) http://${entity-to-host:$1|server0}/e/$1/$2

RewriteRule     ^/([uge])/([^/]+)/?$          /$1/$2/.www/
RewriteRule     ^/([uge])/([^/]+)/([^.]+.+)\  /$1/$2/.www/$3\

```

Move Homedirs to Different Webserver

Description: Many webmasters have asked for a solution to the following situation: They wanted to redirect just all homedirs on a webserver to another webserver. They usually need such things when establishing a newer webserver which will replace the old one over time.

Solution: The solution is trivial with [MOD_REWRITE](#). On the old webserver we just redirect all `/~user/anypath` URLs to `http://newserver/~user/anypath`.

```

RewriteEngine on
RewriteRule     ^/~(.+) http://newserver/~$1 [R,L]

```

Structured Homedirs

Description: Some sites with thousands of users usually use a structured homedir layout, i.e. each homedir is in a subdirectory which begins for instance with the first character of the username. So, `/~foo/anypath` is `/home/f/foo/.www/anypath` while `/~bar/anypath` is `/home/b/bar/.www/anypath`.

Solution: We use the following ruleset to expand the tilde URLs into exactly the above layout.

```

RewriteEngine on
RewriteRule     ^/~((([a-z])[a-z0-9]+)(.*) /home/$2/$1/.www$3

```

Filesystem Reorganization

Description: This really is a hardcore example: a killer application which heavily uses per-directory `RewriteRules` to get a smooth look and feel on the Web while its data structure is never touched or adjusted. Background: *net.sw* is my archive of freely available Unix software packages, which I started to collect in 1992. It is both my hobby and job to do this, because while I'm studying computer science I have also worked for many years as a system and network administrator in my spare time. Every week I need some sort of software so I created a deep hierarchy of directories where I stored the packages:

```

drwxrwxr-x  2 netsw  users    512 Aug  3 18:39 Audio/
drwxrwxr-x  2 netsw  users    512 Jul  9 14:37 Benchmark/
drwxrwxr-x 12 netsw  users    512 Jul  9 00:34 Crypto/
drwxrwxr-x  5 netsw  users    512 Jul  9 00:41 Database/
drwxrwxr-x  4 netsw  users    512 Jul 30 19:25 Dicts/
drwxrwxr-x 10 netsw  users    512 Jul  9 01:54 Graphic/
drwxrwxr-x  5 netsw  users    512 Jul  9 01:58 Hackers/
drwxrwxr-x  8 netsw  users    512 Jul  9 03:19 InfoSys/
drwxrwxr-x  3 netsw  users    512 Jul  9 03:21 Math/
drwxrwxr-x  3 netsw  users    512 Jul  9 03:24 Misc/
drwxrwxr-x  9 netsw  users    512 Aug  1 16:33 Network/
drwxrwxr-x  2 netsw  users    512 Jul  9 05:53 Office/
drwxrwxr-x  7 netsw  users    512 Jul  9 09:24 SoftEng/
drwxrwxr-x  7 netsw  users    512 Jul  9 12:17 System/
drwxrwxr-x 12 netsw  users    512 Aug  3 20:15 Typesetting/
drwxrwxr-x 10 netsw  users    512 Jul  9 14:08 X11/

```

In July 1996 I decided to make this archive public to the world via a nice Web interface. "Nice" means that I wanted to offer an interface where you can browse directly through the archive hierarchy. And "nice" means that I didn't want to change anything inside this hierarchy - not even by putting some CGI scripts at the top of it. Why? Because the above structure should be later accessible via FTP as well, and I didn't want any Web or CGI stuff to be there.

Solution: The solution has two parts: The first is a set of CGI scripts which create all the pages at all directory levels on-the-fly. I put them under `/e/netsw/.www/` as follows:

```

-rw-r--r--  1 netsw  users    1318 Aug  1 18:10 .wwwacl
drwxr-xr-x 18 netsw  users     512 Aug  5 15:51 DATA/
-rw-rw-rw-  1 netsw  users   372982 Aug  5 16:35 LOGFILE
-rw-r--r--  1 netsw  users     659 Aug  4 09:27 TODO
-rw-r--r--  1 netsw  users    5697 Aug  1 18:01 netsw-about.html
-rwxr-xr-x  1 netsw  users     579 Aug  2 10:33 netsw-access.pl
-rwxr-xr-x  1 netsw  users    1532 Aug  1 17:35 netsw-changes.cgi
-rwxr-xr-x  1 netsw  users    2866 Aug  5 14:49 netsw-home.cgi
drwxr-xr-x  2 netsw  users     512 Jul  8 23:47 netsw-img/
-rwxr-xr-x  1 netsw  users   24050 Aug  5 15:49 netsw-lsdir.cgi
-rwxr-xr-x  1 netsw  users    1589 Aug  3 18:43 netsw-search.cgi
-rwxr-xr-x  1 netsw  users    1885 Aug  1 17:41 netsw-tree.cgi
-rw-r--r--  1 netsw  users     234 Jul 30 16:35 netsw-unlimit.lst

```

The `DATA/` subdirectory holds the above directory structure, i.e. the real *net.sw* stuff and gets automatically updated via `rdist` from time to time. The second part of the problem remains: how to link these two structures together into one smooth-looking URL tree? We want to hide the `DATA/` directory from the user while running the appropriate CGI scripts for the various URLs. Here is the solution: first I put the following into the per-directory configuration file in the `DOCUMENTROOT` of the server to rewrite the announced URL `/net.sw/` to the internal path `/e/netsw/`:

```

RewriteRule ^net.sw$ net.sw/ [R]
RewriteRule ^net.sw/(.*)$ e/netsw/$1

```

The first rule is for requests which miss the trailing slash! The second rule does the real thing. And then comes the killer configuration which stays in the per-directory config file `/e/netsw/.www/.wwwacl`:

```
Options          ExecCGI FollowSymLinks Includes MultiViews

RewriteEngine on

# we are reached via /net.sw/ prefix
RewriteBase     /net.sw/

# first we rewrite the root dir to
# the handling cgi script
RewriteRule     ^$                          netsw-home.cgi      [L]
RewriteRule     ^index\.html$               netsw-home.cgi      [L]

# strip out the subdirs when
# the browser requests us from perdir pages
RewriteRule     ^\.+/(netsw-[^/]+/\.+)$     $1                  [L]

# and now break the rewriting for local files
RewriteRule     ^netsw-home\.cgi.*          -                   [L]
RewriteRule     ^netsw-changes\.cgi.*      -                   [L]
RewriteRule     ^netsw-search\.cgi.*       -                   [L]
RewriteRule     ^netsw-tree\.cgi$          -                   [L]
RewriteRule     ^netsw-about\.html$        -                   [L]
RewriteRule     ^netsw-img/\.*$            -                   [L]

# anything else is a subdir which gets handled
# by another cgi script
RewriteRule     !^netsw-lsdir\.cgi.*       -                   [C]
RewriteRule     (.*)                        netsw-lsdir.cgi/$1
```

Some hints for interpretation:

1. Notice the `L` (last) flag and no substitution field (`'-'`) in the forth part
2. Notice the `!` (not) character and the `C` (chain) flag at the first rule in the last part
3. Notice the catch-all pattern in the last rule

NCSA imagemap to Apache `mod_imap`

Description: When switching from the NCSA webserver to the more modern Apache webserver a lot of people want a smooth transition. So they want pages which use their old NCSA `imagemap` program to work under Apache with the modern `MOD_IMAP`. The problem is that there are a lot of hyperlinks around which reference the `imagemap` program via `/cgi-bin/imagemap/path/to/page.map`. Under Apache this has to read just `/path/to/page.map`.

Solution: We use a global rule to remove the prefix on-the-fly for all requests:

```
RewriteEngine on
RewriteRule     ^/cgi-bin/imagemap(.*)     $1 [PT]
```

Search pages in more than one directory

Description: Sometimes it is necessary to let the webserver search for pages in more than one directory. Here Multi-Views or other techniques cannot help.

Solution: We program a explicit ruleset which searches for the files in the directories.

```

RewriteEngine on

# first try to find it in custom/...
# ...and if found stop and be happy:
RewriteCond      /your/docroot/dir1/%{REQUEST_FILENAME}  -f
RewriteRule      ^(.+)  /your/docroot/dir1/$1  [L]

# second try to find it in pub/...
# ...and if found stop and be happy:
RewriteCond      /your/docroot/dir2/%{REQUEST_FILENAME}  -f
RewriteRule      ^(.+)  /your/docroot/dir2/$1  [L]

# else go on for other Alias or ScriptAlias directives,
# etc.
RewriteRule      ^(.+)  -  [PT]

```

Set Environment Variables According To URL Parts

Description: Perhaps you want to keep status information between requests and use the URL to encode it. But you don't want to use a CGI wrapper for all pages just to strip out this information.

Solution: We use a rewrite rule to strip out the status information and remember it via an environment variable which can be later dereferenced from within XSSI or CGI. This way a URL `/foo/S=java/bar/` gets translated to `/foo/bar/` and the environment variable named `STATUS` is set to the value "java".

```

RewriteEngine on
RewriteRule      ^(.*)/S=([^\/]+)/(.*)      $1/$3 [E=STATUS:$2]

```

Virtual User Hosts

Description: Assume that you want to provide `www.username.host.domain.com` for the homepage of `username` via just DNS A records to the same machine and without any virtualhosts on this machine.

Solution: For HTTP/1.0 requests there is no solution, but for HTTP/1.1 requests which contain a `Host: HTTP` header we can use the following ruleset to rewrite `http://www.username.host.com/anypath` internally to `/home/username/anypath`:

```

RewriteEngine on
RewriteCond      %{HTTP_HOST}                  ^www\.[^.]+\\.host\.com$
RewriteRule      ^(.+)                          %{HTTP_HOST}$1          [C]
RewriteRule      ^www\.[^.]+\\.host\.com(.*)    /home/$1$2

```

Redirect Homedirs For Foreigners

Description: We want to redirect homedir URLs to another webserver `www.somewhere.com` when the requesting user does not stay in the local domain `ourdomain.com`. This is sometimes used in virtual host contexts.

Solution: Just a rewrite condition:

```
RewriteEngine on
RewriteCond  %{REMOTE_HOST}  !^.\.ourdomain\.com$
RewriteRule  ^(/~.+ )         http://www.somewhere.com/$1 [R,L]
```

Redirect Failing URLs To Other Webserver

Description: A typical FAQ about URL rewriting is how to redirect failing requests on webserver A to webserver B. Usually this is done via `ERRORDOCUMENT` CGI-scripts in Perl, but there is also a `MOD_REWRITE` solution. But notice that this performs more poorly than using an `ERRORDOCUMENT` CGI-script!

Solution: The first solution has the best performance but less flexibility, and is less error safe:

```
RewriteEngine on
RewriteCond  /your/docroot/%{REQUEST_FILENAME}  !-f
RewriteRule  ^(.+)                               http://webserverB.dom/$1
```

The problem here is that this will only work for pages inside the `DOCUMENTROOT`. While you can add more Conditions (for instance to also handle homedirs, etc.) there is better variant:

```
RewriteEngine on
RewriteCond  %{REQUEST_URI}  !-U
RewriteRule  ^(.+)           http://webserverB.dom/$1
```

This uses the URL look-ahead feature of `MOD_REWRITE`. The result is that this will work for all types of URLs and is a safe way. But it does a performance impact on the webserver, because for every request there is one more internal subrequest. So, if your webserver runs on a powerful CPU, use this one. If it is a slow machine, use the first approach or better a `ERRORDOCUMENT` CGI-script.

Extended Redirection

Description: Sometimes we need more control (concerning the character escaping mechanism) of URLs on redirects. Usually the Apache kernels URL escape function also escapes anchors, i.e. URLs like `"url#anchor"`. You cannot use this directly on redirects with `MOD_REWRITE` because the `uri_escape()` function of Apache would also escape the hash character. How can we redirect to such a URL?

Solution: We have to use a kludge by the use of a NPH-CGI script which does the redirect itself. Because here no escaping is done (NPH=non-parseable headers). First we introduce a new URL scheme `xredirect:` by the following per-server config-line (should be one of the last rewrite rules):

```
RewriteRule ^xredirect:(.+) /path/to/nph-xredirect.cgi/$1 \
    [T=application/x-httpd-cgi,L]
```

This forces all URLs prefixed with `xredirect:` to be piped through the `nph-xredirect.cgi` program. And this program just looks like:

```
#!/path/to/perl
##
##  nph-xredirect.cgi -- NPH/CGI script for extended redirects
##  Copyright (c) 1997 Ralf S. Engelschall, All Rights Reserved.
##

$| = 1;
$url = $ENV{'PATH_INFO'};

print "HTTP/1.0 302 Moved Temporarily\n";
print "Server: $ENV{'SERVER_SOFTWARE'}\n";
print "Location: $url\n";
print "Content-type: text/html\n";
print "\n";
print "<html>\n";
print "<head>\n";
print "<title>302 Moved Temporarily (EXTENDED)</title>\n";
print "</head>\n";
print "<body>\n";
print "<h1>Moved Temporarily (EXTENDED)</h1>\n";
print "The document has moved <a HREF=\"$url\">here</a>.<p>\n";
print "</body>\n";
print "</html>\n";

##EOF##
```

This provides you with the functionality to do redirects to all URL schemes, i.e. including the one which are not directly accepted by `MOD_REWRITE`. For instance you can now also redirect to `news:newsgroup` via

```
RewriteRule ^anyurl xredirect:news:newsgroup
```

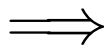

Notice: You have not to put `[R]` or `[R,L]` to the above rule because the `xredirect:` need to be expanded later by our special "pipe through" rule above.

Archive Access Multiplexer

Description: Do you know the great CPAN (Comprehensive Perl Archive Network) under <http://www.perl.com/CPAN/>? This does a redirect to one of several FTP servers around the world which carry a CPAN mirror and is approximately near the location of the requesting client. Actually this can be called an FTP access multiplexing service. While CPAN runs via CGI scripts, how can a similar approach implemented via `MOD_REWRITE`?

Solution: First we notice that from version 3.0.0 `MOD_REWRITE` can also use the "ftp:" scheme on redirects. And second, the location approximation can be done by a `REWRITEMAP` over the top-level domain of the client. With a tricky chained ruleset we can use this top-level domain as a key to our multiplexing map.

```

RewriteEngine on
RewriteMap      multiplex      txt:/path/to/map.cxan
RewriteRule     ^/CxAN/(.*)    %{REMOTE_HOST}::$1      [C]
RewriteRule     ^.+\.([a-zA-Z]+)::(.*)$  ${multiplex:$1|ftp.default.dom}$2  [R,L]

##
##  map.cxan -- Multiplexing Map for CxAN
##

de      ftp://ftp.cxan.de/CxAN/
uk      ftp://ftp.cxan.uk/CxAN/
com     ftp://ftp.cxan.com/CxAN/
:
##EOF##

```

Time-Dependent Rewriting

Description: When tricks like time-dependent content should happen a lot of webmasters still use CGI scripts which do for instance redirects to specialized pages. How can it be done via `MOD_REWRITE`?

Solution: There are a lot of variables named `TIME_XXX` for rewrite conditions. In conjunction with the special lexicographic comparison patterns `<STRING`, `>STRING` and `=STRING` we can do time-dependent redirects:

```

RewriteEngine on
RewriteCond     %{TIME_HOUR}%{TIME_MIN} >0700
RewriteCond     %{TIME_HOUR}%{TIME_MIN} <1900
RewriteRule     ^foo\.html$             foo.day.html
RewriteRule     ^foo\.html$             foo.night.html

```

This provides the content of `foo.day.html` under the URL `foo.html` from 07:00–19:00 and at the remaining time the contents of `foo.night.html`. Just a nice feature for a homepage...

Backward Compatibility for YYYY to XXXX migration

Description: How can we make URLs backward compatible (still existing virtually) after migrating `document.YYYY` to `document.XXXX`, e.g. after translating a bunch of `.html` files to `.phtml`?

Solution: We just rewrite the name to its basename and test for existence of the new extension. If it exists, we take that name, else we rewrite the URL to its original state.

```

# backward compatibility ruleset for
# rewriting document.html to document.phtml
# when and only when document.phtml exists
# but no longer document.html
RewriteEngine on
RewriteBase /~quux/
# parse out basename, but remember the fact
RewriteRule ^(.*)\.html$ $1 [C,E=WasHTML:yes]
# rewrite to document.phtml if exists
RewriteCond %{REQUEST_FILENAME}.phtml -f
RewriteRule ^(.*)$ $1.phtml [S=1]
# else reverse the previous basename cutout
RewriteCond %{ENV:WasHTML} ^yes$
RewriteRule ^(.*)$ $1.html

```

Content Handling

From Old to New (intern)

Description: Assume we have recently renamed the page `foo.html` to `bar.html` and now want to provide the old URL for backward compatibility. Actually we want that users of the old URL even not recognize that the pages was renamed.

Solution: We rewrite the old URL to the new one internally via the following rule:

```

RewriteEngine on
RewriteBase /~quux/
RewriteRule ^foo\.html$ bar.html

```

From Old to New (extern)

Description: Assume again that we have recently renamed the page `foo.html` to `bar.html` and now want to provide the old URL for backward compatibility. But this time we want that the users of the old URL get hinted to the new one, i.e. their browsers Location field should change, too.

Solution: We force a HTTP redirect to the new URL which leads to a change of the browsers and thus the users view:

```

RewriteEngine on
RewriteBase /~quux/
RewriteRule ^foo\.html$ bar.html [R]

```

Browser Dependent Content

Description: At least for important top-level pages it is sometimes necessary to provide the optimum of browser dependent content, i.e. one has to provide a maximum version for the latest Netscape variants, a minimum version for the Lynx browsers and a average feature version for all others.

Solution: We cannot use content negotiation because the browsers do not provide their type in that form. Instead we have to act on the HTTP header "User-Agent". The following config does the following: If the HTTP header "User-Agent" begins with "Mozilla/3", the page `foo.html` is rewritten to `foo.NS.html` and the rewriting stops. If the browser is "Lynx" or "Mozilla" of version 1 or 2 the URL becomes `foo.20.html`. All other browsers receive page `foo.32.html`. This is done by the following ruleset:

```

RewriteCond %{HTTP_USER_AGENT} ^Mozilla/3.*
RewriteRule ^foo\.html$      foo.NS.html          [L]

RewriteCond %{HTTP_USER_AGENT} ^Lynx/.*          [OR]
RewriteCond %{HTTP_USER_AGENT} ^Mozilla/[12].*
RewriteRule ^foo\.html$      foo.20.html          [L]

RewriteRule ^foo\.html$      foo.32.html          [L]

```

Dynamic Mirror

Description: Assume there are nice webpages on remote hosts we want to bring into our namespace. For FTP servers we would use the `mirror` program which actually maintains an explicit up-to-date copy of the remote data on the local machine. For a webserver we could use the program `webcopy` which acts similar via HTTP. But both techniques have one major drawback: The local copy is always just as up-to-date as often we run the program. It would be much better if the mirror is not a static one we have to establish explicitly. Instead we want a dynamic mirror with data which gets updated automatically when there is need (updated data on the remote host).

Solution: To provide this feature we map the remote webpage or even the complete remote webarea to our namespace by the use of the Proxy Throughput feature (flag [P]):

```

RewriteEngine on
RewriteBase    /~quux/
RewriteRule    ^hotsheet/(.*)$ http://www.tstimpreso.com/hotsheet/$1 [P]

```

```

RewriteEngine on
RewriteBase    /~quux/
RewriteRule    ^usa-news\.html$ http://www.quux-corp.com/news/index.html [P]

```

Reverse Dynamic Mirror

Description: ...

Solution:

```

RewriteEngine on
RewriteCond    /mirror/of/remotesite/$1          -U
RewriteRule    ^http://www\.remotesite\.com/(.*)$ /mirror/of/remotesite/$1

```

Retrieve Missing Data from Intranet

Description: This is a tricky way of virtually running a corporate (external) Internet webserver (`www.quux-corp.dom`), while actually keeping and maintaining its data on a (internal) Intranet webserver (`www2.quux-corp.dom`) which is protected by a firewall. The trick is that on the external webserver we retrieve the requested data on-the-fly from the internal one.

Solution: First, we have to make sure that our firewall still protects the internal webserver and that only the external webserver is allowed to retrieve data from it. For a packet-filtering firewall we could for instance configure a firewall ruleset like the following:

```
ALLOW Host www.quux-corp.dom Port >1024 --> Host www2.quux-corp.dom Port 80
DENY  Host *                      Port *      --> Host www2.quux-corp.dom Port 80
```

Just adjust it to your actual configuration syntax. Now we can establish the `MOD_REWRITE` rules which request the missing data in the background through the proxy throughput feature:

```
RewriteRule ^/^( [^/]+ )/? (.*)           /home/$1/.www/$2
RewriteCond %{REQUEST_FILENAME}          !-f
RewriteCond %{REQUEST_FILENAME}          !-d
RewriteRule ^/home/( [^/]+ )/.www/? (.*) http://www2.quux-corp.dom/~$1/pub/$2 [P]
```

Load Balancing

Description: Suppose we want to load balance the traffic to `www.foo.com` over `www[0-5].foo.com` (a total of 6 servers). How can this be done?

Solution: There are a lot of possible solutions for this problem. We will discuss first a commonly known DNS-based variant and then the special one with `MOD_REWRITE`:

1. DNS Round-Robin

The simplest method for load-balancing is to use the DNS round-robin feature of BIND. Here you just configure `www[0-9].foo.com` as usual in your DNS with A(address) records, e.g.

```
www0  IN  A      1.2.3.1
www1  IN  A      1.2.3.2
www2  IN  A      1.2.3.3
www3  IN  A      1.2.3.4
www4  IN  A      1.2.3.5
www5  IN  A      1.2.3.6
```

Then you additionally add the following entry:

```
www   IN  CNAME  www0.foo.com.
      IN  CNAME  www1.foo.com.
      IN  CNAME  www2.foo.com.
      IN  CNAME  www3.foo.com.
      IN  CNAME  www4.foo.com.
      IN  CNAME  www5.foo.com.
      IN  CNAME  www6.foo.com.
```

Notice that this seems wrong, but is actually an intended feature of BIND and can be used in this way. However, now when `www.foo.com` gets resolved, BIND gives out `www0-www6` - but in a slightly permuted/rotated order every time. This way the clients are spread over the various servers. But notice that this not a perfect load balancing scheme, because DNS resolve information gets cached by the other nameservers on the net, so once a client has resolved `www.foo.com` to a particular `wwwN.foo.com`, all subsequent requests also go to this particular name `wwwN.foo.com`. But the final result is ok, because the total sum of the requests are really spread over the various webservers.

2. DNS Load-Balancing

A sophisticated DNS-based method for load-balancing is to use the program `lbname`d which can be found at <http://www.stanford.edu/~schemers/docs/lbname/d/lbname.html>²⁴. It is a Perl 5 program in conjunction with auxilliary tools which provides a real load-balancing for DNS.

3. Proxy Throughput Round-Robin

In this variant we use `MOD_REWRITE` and its proxy throughput feature. First we dedicate `www0.foo.com` to be actually `www.foo.com` by using a single

```
www    IN  CNAME  www0.foo.com.
```

entry in the DNS. Then we convert `www0.foo.com` to a proxy-only server, i.e. we configure this machine so all arriving URLs are just pushed through the internal proxy to one of the 5 other servers (`www1-www5`). To accomplish this we first establish a ruleset which contacts a load balancing script `lb.pl` for all URLs.

```
RewriteEngine on
RewriteMap    lb          prg:/path/to/lb.pl
RewriteRule   ^/(.+)$    ${lb:$1}          [P,L]
```

Then we write `lb.pl`:

```
#!/path/to/perl
##
## lb.pl -- load balancing script
##

$| = 1;

$name    = "www";      # the hostname base
$first   = 1;          # the first server (not 0 here, because 0 is myself)
$last    = 5;          # the last server in the round-robin
$domain  = "foo.dom"; # the domainname

$cnt = 0;
while (<STDIN>) {
    $cnt = (($cnt+1) % ($last+1-$first));
    $server = sprintf("%s%d.%s", $name, $cnt+$first, $domain);
    print "http://$server/$_";
}

##EOF##
```

⇒ A last notice: Why is this useful? Seems like `www0.foo.com` still is overloaded? The answer is yes, it is overloaded, but with plain proxy throughput requests, only! All SSI, CGI, ePerl, etc. processing is completely done on the other machines. This is the essential point.

²⁴<http://www.stanford.edu/~schemers/docs/lbname/d/lbname.html>

4. Hardware/TCP Round-Robin

There is a hardware solution available, too. Cisco has a beast called LocalDirector which does a load balancing at the TCP/IP level. Actually this is some sort of a circuit level gateway in front of a webcluster. If you have enough money and really need a solution with high performance, use this one.

New MIME-type, New Service

Description: On the net there are a lot of nifty CGI programs. But their usage is usually boring, so a lot of webmaster don't use them. Even Apache's Action handler feature for MIME-types is only appropriate when the CGI programs don't need special URLs (actually `PATH_INFO` and `QUERY_STRING`) as their input. First, let us configure a new file type with extension `.scgi` (for secure CGI) which will be processed by the popular `cgiwrap` program. The problem here is that for instance we use a Homogeneous URL Layout (see above) a file inside the user homedirs has the URL `/u/user/foo/bar.scgi`. But `cgiwrap` needs the URL in the form `/~user/foo/bar.scgi/`. The following rule solves the problem:

```
RewriteRule ^/[uqe]/([^/]+)/\.www/(.+)\.scgi(.*) ...
... /internal/cgi/user/cgiwrap/~$1/$2.scgi$3 [NS,T=application/x-http-cgi]
```

Or assume we have some more nifty programs: `wwwlog` (which displays the `access.log` for a URL subtree and `wwidx` (which runs `Glimpse` on a URL subtree). We have to provide the URL area to these programs so they know on which area they have to act on. But usually this ugly, because they are all the times still requested from that areas, i.e. typically we would run the `swidx` program from within `/u/user/foo/` via hyperlink to

```
/internal/cgi/user/swidx?i=/u/user/foo/
```

which is ugly. Because we have to hard-code **both** the location of the area **and** the location of the CGI inside the hyperlink. When we have to reorganize the area, we spend a lot of time changing the various hyperlinks.

Solution: The solution here is to provide a special new URL format which automatically leads to the proper CGI invocation. We configure the following:

```
RewriteRule ^/([uqe])/([^/]+)/(?.*)/\* /internal/cgi/user/wwidx?i=/$1/$2$3/
RewriteRule ^/([uqe])/([^/]+)/(?.*):log /internal/cgi/user/wwwlog?f=/$1/$2$3
```

Now the hyperlink to search at `/u/user/foo/` reads only

```
HREF="*" "
```

which internally gets automatically transformed to

```
/internal/cgi/user/wwidx?i=/u/user/foo/
```

The same approach leads to an invocation for the access log CGI program when the hyperlink `:log` gets used.

From Static to Dynamic

Description: How can we transform a static page `foo.html` into a dynamic variant `foo.cgi` in a seamless way, i.e. without notice by the browser/user.

Solution: We just rewrite the URL to the CGI-script and force the correct MIME-type so it gets really run as a CGI-script. This way a request to `/~quux/foo.html` internally leads to the invocation of `/~quux/foo.cgi`.

```
RewriteEngine on
RewriteBase /~quux/
RewriteRule ^foo\.html$ foo.cgi [T=application/x-httpd-cgi]
```

On-the-fly Content-Regeneration

Description: Here comes a really esoteric feature: Dynamically generated but statically served pages, i.e. pages should be delivered as pure static pages (read from the filesystem and just passed through), but they have to be generated dynamically by the webserver if missing. This way you can have CGI-generated pages which are statically served unless one (or a cronjob) removes the static contents. Then the contents gets refreshed.

Solution: This is done via the following ruleset:

```
RewriteCond %{REQUEST_FILENAME} !-s
RewriteRule ^page\.html$ page.cgi [T=application/x-httpd-cgi,L]
```

Here a request to `page.html` leads to an internal run of a corresponding `page.cgi` if `page.html` is still missing or has filesize null. The trick here is that `page.cgi` is a usual CGI script which (additionally to its `STDOUT`) writes its output to the file `page.html`. Once it was run, the server sends out the data of `page.html`. When the webmaster wants to force a refresh the contents, he just removes `page.html` (usually done by a cronjob).

Document With Autorefresh

Description: Wouldn't it be nice while creating a complex webpage if the webbrowser would automatically refresh the page every time we write a new version from within our editor? Impossible?

Solution: No! We just combine the MIME multipart feature, the webserver NPH feature and the URL manipulation power of `MOD_REWRITE`. First, we establish a new URL feature: Adding just `:refresh` to any URL causes this to be refreshed every time it gets updated on the filesystem.

```
RewriteRule ^(/[uqe]/[^\s]+/?.*):refresh /internal/cgi/apache/nph-refresh?f=$1
```

Now when we reference the URL

```
/u/foo/bar/page.html:refresh
```

this leads to the internal invocation of the URL

```
/internal/cgi/apache/nph-refresh?f=/u/foo/bar/page.html
```

The only missing part is the NPH-CGI script. Although one would usually say "left as an exercise to the reader" ;-) I will provide this, too.

```

#!/sw/bin/perl
##
##  nph-refresh -- NPH/CGI script for auto refreshing pages
##  Copyright (c) 1997 Ralf S. Engelschall, All Rights Reserved.
##
$| = 1;

#  split the QUERY_STRING variable
@pairs = split(/&/, $ENV{'QUERY_STRING'});
foreach $pair (@pairs) {
    ($name, $value) = split(/=/, $pair);
    $name =~ tr/A-Z/a-z/;
    $name = 'QS_' . $name;
    $value =~ s/%([a-fA-F0-9][a-fA-F0-9])/pack("C", hex($1))/eg;
    eval "\$$name = \"$value\"";
}
$QS_s = 1 if ($QS_s eq '');
$QS_n = 3600 if ($QS_n eq '');
if ($QS_f eq '') {
    print "HTTP/1.0 200 OK\n";
    print "Content-type: text/html\n\n";
    print "&lt;b&gt;ERROR&lt;/b&gt;: No file given\n";
    exit(0);
}
if (! -f $QS_f) {
    print "HTTP/1.0 200 OK\n";
    print "Content-type: text/html\n\n";
    print "&lt;b&gt;ERROR&lt;/b&gt;: File $QS_f not found\n";
    exit(0);
}

sub print_http_headers_multipart_begin {
    print "HTTP/1.0 200 OK\n";
    $bound = "ThisRandomString12345";
    print "Content-type: multipart/x-mixed-replace;boundary=$bound\n";
    &print_http_headers_multipart_next;
}

sub print_http_headers_multipart_next {
    print "\n--$bound\n";
}

sub print_http_headers_multipart_end {
    print "\n--$bound--\n";
}

sub displayhtml {
    local($buffer) = @_;
    $len = length($buffer);
    print "Content-type: text/html\n";
    print "Content-length: $len\n\n";
    print $buffer;
}

sub readfile {
    local($file) = @_;
    local(*FP, $size, $buffer, $bytes);
    ($x, $x, $x, $x, $x, $x, $x, $x, $size) = stat($file);
    $size = sprintf("%d", $size);
    open(FP, "&lt;$file");
    $bytes = sysread(FP, $buffer, $size);
    close(FP);
    return $buffer;
}

```

Mass Virtual Hosting

Description: The `<VIRTUALHOST>` feature of Apache is nice and works great when you just have a few dozens virtual hosts. But when you are an ISP and have hundreds of virtual hosts to provide this feature is not the best choice.

Solution: To provide this feature we map the remote webpage or even the complete remote webarea to our namespace by the use of the Proxy Throughput feature (flag `[P]`):

```
##
## vhost.map
##
www.vhost1.dom:80 /path/to/docroot/vhost1
www.vhost2.dom:80 /path/to/docroot/vhost2
:
www.vhostN.dom:80 /path/to/docroot/vhostN
```

```

##
## httpd.conf
##
:
# use the canonical hostname on redirects, etc.
UseCanonicalName on

:
# add the virtual host in front of the CLF-format
CustomLog /path/to/access_log "%{VHOST}e %h %l %u %t \"%r\" %>s %b"
:

# enable the rewriting engine in the main server
RewriteEngine on

# define two maps: one for fixing the URL and one which defines
# the available virtual hosts with their corresponding
# DocumentRoot.
RewriteMap lowercase int:tolower
RewriteMap vhost txt:/path/to/vhost.map

# Now do the actual virtual host mapping
# via a huge and complicated single rule:
#
# 1. make sure we don't map for common locations
RewriteCond %{REQUEST_URI} !~/commonurl1/*
RewriteCond %{REQUEST_URI} !~/commonurl2/*
:
RewriteCond %{REQUEST_URI} !~/commonurlN/*
#
# 2. make sure we have a Host header, because
# currently our approach only supports
# virtual hosting through this header
RewriteCond %{HTTP_HOST} !^$
#
# 3. lowercase the hostname
RewriteCond ${lowercase:%{HTTP_HOST}|NONE} ^(.+)$
#
# 4. lookup this hostname in vhost.map and
# remember it only when it is a path
# (and not "NONE" from above)
RewriteCond ${vhost:%1} ^(/.*)$
#
# 5. finally we can map the URL to its docroot location
# and remember the virtual host for logging puposes
RewriteRule ^(/.*)$ %1/%1 [E=VHOST:${lowercase:%{HTTP_HOST}}]
:

```

Access Restriction

Blocking of Robots

Description: How can we block a really annoying robot from retrieving pages of a specific webarea? A `/robots.txt` file containing entries of the "Robot Exclusion Protocol" is typically not enough to get rid of such a robot.

Solution: We use a ruleset which forbids the URLs of the webarea `/~quux/foo/arc/` (perhaps a very deep directory indexed area where the robot traversal would create big server load). We have to make sure that we forbid access only to the particular robot, i.e. just forbidding the host where the robot runs is not enough. This would block users from this host, too. We accomplish this by also matching the User-Agent HTTP header information.

```
RewriteCond %{HTTP_USER_AGENT}    ^NameOfBadRobot.*
RewriteCond %{REMOTE_ADDR}        ^123\.45\.67\.[8-9]$
RewriteRule  ^/~quux/foo/arc/.+   - [F]
```

Blocked Inline-Images

Description: Assume we have under `http://www.quux-corp.de/~quux/` some pages with inlined GIF graphics. These graphics are nice, so others directly incorporate them via hyperlinks to their pages. We don't like this practice because it adds useless traffic to our server.

Solution: While we cannot 100% protect the images from inclusion, we can at least restrict the cases where the browser sends a HTTP Referer header.

```
RewriteCond %{HTTP_REFERER}    !^$
RewriteCond %{HTTP_REFERER}    !^http://www.quux-corp.de/~quux/.*$ [NC]
RewriteRule  .*\.gif$          - [F]
```

```
RewriteCond %{HTTP_REFERER}    !^$
RewriteCond %{HTTP_REFERER}    !.* /foo-with-gif\.html$
RewriteRule  ^inlined-in-foo\.gif$ - [F]
```

Host Deny

Description: How can we forbid a list of externally configured hosts from using our server?

Solution: For Apache `>= 1.3b6`:

```
RewriteEngine on
RewriteMap    hosts-deny    txt:/path/to/hosts.deny
RewriteCond   ${hosts-deny:%{REMOTE_HOST}|NOT-FOUND} !=NOT-FOUND [OR]
RewriteCond   ${hosts-deny:%{REMOTE_ADDR}|NOT-FOUND} !=NOT-FOUND
RewriteRule   ^/.*         - [F]
```

For Apache `<= 1.3b6`:

```

RewriteEngine on
RewriteMap    hosts-deny    txt:/path/to/hosts.deny
RewriteRule   ^/(.*)$ ${hosts-deny:%{REMOTE_HOST}|NOT-FOUND}/$1
RewriteRule   !^NOT-FOUND/. * - [F]
RewriteRule   ^NOT-FOUND/(.*)$ ${hosts-deny:%{REMOTE_ADDR}|NOT-FOUND}/$1
RewriteRule   !^NOT-FOUND/. * - [F]
RewriteRule   ^NOT-FOUND/(.*)$ /$1

##
##  hosts.deny
##
##  ATTENTION! This is a map, not a list, even when we treat it as such.
##              mod_rewrite parses it for key/value pairs, so at least a
##              dummy value "-" must be present for each entry.
##
193.102.180.41 -
bsdt11.sdm.de -
192.76.162.40 -

```

Proxy Deny

Description: How can we forbid a certain host or even a user of a special host from using the Apache proxy?

Solution: We first have to make sure `MOD_REWRITE` is below(!) `MOD_PROXY` in the Configuration file when compiling the Apache webserver. This way it gets called *before* `MOD_PROXY`. Then we configure the following for a host-dependent deny...

```

RewriteCond %{REMOTE_HOST} ^badhost\.mydomain\.com$
RewriteRule !^http://[^\.]\.mydomain.com.* - [F]

```

...and this one for a user@host-dependent deny:

```

RewriteCond %{REMOTE_IDENT}@%{REMOTE_HOST} ^badguy@badhost\.mydomain\.com$
RewriteRule !^http://[^\.]\.mydomain.com.* - [F]

```

Special Authentication Variant

Description: Sometimes a very special authentication is needed, for instance a authentication which checks for a set of explicitly configured users. Only these should receive access and without explicit prompting (which would occur when using the Basic Auth via `MOD_AUTH`).

Solution: We use a list of rewrite conditions to exclude all except our friends:

```

RewriteCond %{REMOTE_IDENT}@%{REMOTE_HOST} !^friend1@client1.quux-corp\.com$
RewriteCond %{REMOTE_IDENT}@%{REMOTE_HOST} !^friend2@client2.quux-corp\.com$
RewriteCond %{REMOTE_IDENT}@%{REMOTE_HOST} !^friend3@client3.quux-corp\.com$
RewriteRule ^/~quux/only-for-friends/ - [F]

```

Referer-based Deflector

Description: How can we program a flexible URL Deflector which acts on the "Referer" HTTP header and can be configured with as many referring pages as we like?

Solution: Use the following really tricky ruleset...

```

RewriteMap deflector txt:/path/to/deflector.map

RewriteCond %{HTTP_REFERER} !=""
RewriteCond ${deflector:%{HTTP_REFERER}} ^-$
RewriteRule ^.* %{HTTP_REFERER} [R,L]

RewriteCond %{HTTP_REFERER} !=""
RewriteCond ${deflector:%{HTTP_REFERER}|NOT-FOUND} !=NOT-FOUND
RewriteRule ^.* ${deflector:%{HTTP_REFERER}} [R,L]

```

... in conjunction with a corresponding rewrite map:

```

##
## deflector.map
##

http://www.badguys.com/bad/index.html -
http://www.badguys.com/bad/index2.html -
http://www.badguys.com/bad/index3.html http://somewhere.com/

```

This automatically redirects the request back to the referring page (when "-" is used as the value in the map) or to a specific URL (when an URL is specified in the map as the second argument).

Other

External Rewriting Engine

Description: A FAQ: How can we solve the FOO/BAR/QUUX/etc. problem? There seems no solution by the use of [MOD_REWRITE](#)...

Solution: Use an external [REWRITEMAP](#), i.e. a program which acts like a [REWRITEMAP](#). It is run once on startup of Apache receives the requested URLs on STDIN and has to put the resulting (usually rewritten) URL on STDOUT (same order!).

```
RewriteEngine on
RewriteMap    quux-map      prg:/path/to/map.quux.pl
RewriteRule   ^/~quux/(.*)$  /~quux/${quux-map:$1}

#!/path/to/perl

#  disable buffered I/O which would lead
#  to deadloops for the Apache server
$| = 1;

#  read URLs one per line from stdin and
#  generate substitution URL on stdout
while (<>) {
    s|^foo/|bar/|;
    print $_;
}
```

This is a demonstration-only example and just rewrites all URLs `/~quux/foo/...` to `/~quux/bar/...`. Actually you can program whatever you like. But notice that while such maps can be **used** also by an average user, only the system administrator can **define** it.

Chapter 3

Apache Virtual Host documentation

3.1 Apache Virtual Host documentation

The term Virtual Host refers to the practice of running more than one web site (such as `www.company1.com` and `www.company2.com`) on a single machine. Virtual hosts can be "IP-based (p. 114)", meaning that you have a different IP address for every web site, or "name-based (p. 111)", meaning that you have multiple names running on each IP address. The fact that they are running on the same physical server is not apparent to the end user.

Apache was one of the first servers to support IP-based virtual hosts right out of the box. Versions 1.1 and later of Apache support both IP-based and name-based virtual hosts (vhosts). The latter variant of virtual hosts is sometimes also called *host-based* or *non-IP virtual hosts*.

Below is a list of documentation pages which explain all details of virtual host support in Apache version 1.3 and later.

See also

- [MOD_VHOST_ALIAS](#)
- [Name-based virtual hosts \(p. 111\)](#)
- [IP-based virtual hosts \(p. 114\)](#)
- [Virtual host examples \(p. 121\)](#)
- [File descriptor limits \(p. 134\)](#)
- [Mass virtual hosting \(p. 116\)](#)
- [Details of host matching \(p. 129\)](#)

Virtual Host Support

- [Name-based Virtual Hosts \(p. 111\)](#) (More than one web site per IP address)
- [IP-based Virtual Hosts \(p. 114\)](#) (An IP address for each web site)
- [Virtual Host examples for common setups \(p. 121\)](#)
- [File Descriptor Limits \(p. 134\)](#) (or, *Too many log files*)
- [Dynamically Configured Mass Virtual Hosting \(p. 116\)](#)
- [In-Depth Discussion of Virtual Host Matching \(p. 129\)](#)

Configuration directives

- [<VIRTUALHOST>](#)
- [NAMEVIRTUALHOST](#)
- [SERVERNAME](#)
- [SERVERALIAS](#)
- [SERVERPATH](#)

If you are trying to debug your virtual host configuration, you may find the Apache `-S` command line switch useful. That is, type the following command:

```
/usr/local/apache2/bin/httpd -S
```

This command will dump out a description of how Apache parsed the configuration file. Careful examination of the IP addresses and server names may help uncover configuration mistakes. (See the docs for the `httpd` program for other command line options)

3.2 Name-based Virtual Host Support

This document describes when and how to use name-based virtual hosts.

See also

- [IP-based Virtual Host Support](#) (p. 114)
- [An In-Depth Discussion of Virtual Host Matching](#) (p. 129)
- [Dynamically configured mass virtual hosting](#) (p. 116)
- [Virtual Host examples for common setups](#) (p. 121)
- [ServerPath configuration example](#) (p. 121)

Name-based vs. IP-based Virtual Hosts

IP-based virtual hosts use the IP address of the connection to determine the correct virtual host to serve. Therefore you need to have a separate IP address for each host. With name-based virtual hosting, the server relies on the client to report the hostname as part of the HTTP headers. Using this technique, many different hosts can share the same IP address.

Name-based virtual hosting is usually simpler, since you need only configure your DNS server to map each hostname to the correct IP address and then configure the Apache HTTP Server to recognize the different hostnames. Name-based virtual hosting also eases the demand for scarce IP addresses. Therefore you should use name-based virtual hosting unless there is a specific reason to choose IP-based virtual hosting. Some reasons why you might consider using IP-based virtual hosting:

- Some ancient clients are not compatible with name-based virtual hosting. For name-based virtual hosting to work, the client must send the HTTP Host header. This is required by HTTP/1.1, and is implemented by all modern HTTP/1.0 browsers as an extension. If you need to support obsolete clients and still use name-based virtual hosting, a possible technique is discussed at the end of this document.
- Name-based virtual hosting cannot be used with SSL secure servers because of the nature of the SSL protocol.
- Some operating systems and network equipment implement bandwidth management techniques that cannot differentiate between hosts unless they are on separate IP addresses.

Using Name-based Virtual Hosts

Related Modules	Related Directives
CORE	DOCUMENTROOT NAMEVIRTUALHOST SERVERALIAS SERVERNAME SERVERPATH <VIRTUALHOST>

To use name-based virtual hosting, you must designate the IP address (and possibly port) on the server that will be accepting requests for the hosts. This is configured using the [NAMEVIRTUALHOST](#) directive. In the normal case where any and all IP addresses on the server should be used, you can use `*` as the argument to [NAMEVIRTUALHOST](#). If you're planning to use multiple ports (e.g. running SSL) you should add a Port to the argument, such as `*:80`. Note that mentioning an IP address in a [NAMEVIRTUALHOST](#) directive does not automatically make the server listen to that IP address. See [Setting which addresses and ports Apache uses](#) (p. 57) for more details. In addition, any IP address specified here must be associated with a network interface on the server.

The next step is to create a `<VIRTUALHOST>` block for each different host that you would like to serve. The argument to the `<VIRTUALHOST>` directive should be the same as the argument to the `NAMEVIRTUALHOST` directive (ie, an IP address, or `*` for all addresses). Inside each `<VIRTUALHOST>` block, you will need at minimum a `SERVERNAME` directive to designate which host is served and a `DOCUMENTROOT` directive to show where in the filesystem the content for that host lives.

⇒ Main host goes away

If you are adding virtual hosts to an existing web server, you must also create a `<VIRTUALHOST>` block for the existing host. The `SERVERNAME` and `DOCUMENTROOT` included in this virtual host should be the same as the global `SERVERNAME` and `DOCUMENTROOT`. List this virtual host first in the configuration file so that it will act as the default host.

For example, suppose that you are serving the domain `www.domain.tld` and you wish to add the virtual host `www.otherdomain.tld`, which points at the same IP address. Then you simply add the following to `httpd.conf`:

```
NameVirtualHost *:80
<VirtualHost *:80>
    ServerName www.domain.tld
    ServerAlias domain.tld *.domain.tld
    DocumentRoot /www/domain
</VirtualHost>
<VirtualHost *:80>
    ServerName www.otherdomain.tld
    DocumentRoot /www/otherdomain
</VirtualHost>
```

You can alternatively specify an explicit IP address in place of the `*` in both the `NAMEVIRTUALHOST` and `<VIRTUALHOST>` directives. For example, you might want to do this in order to run some name-based virtual hosts on one IP address, and either IP-based, or another set of name-based virtual hosts on another address.

Many servers want to be accessible by more than one name. This is possible with the `SERVERALIAS` directive, placed inside the `<VIRTUALHOST>` section. For example in the first `<VIRTUALHOST>` block above, the `SERVERALIAS` directive indicates that the listed names are other names which people can use to see that same web site:

```
ServerAlias domain.tld *.domain.tld
```

then requests for all hosts in the `domain.tld` domain will be served by the `www.domain.tld` virtual host. The wildcard characters `*` and `?` can be used to match names. Of course, you can't just make up names and place them in `SERVERNAME` or `ServerAlias`. You must first have your DNS server properly configured to map those names to an IP address associated with your server.

Finally, you can fine-tune the configuration of the virtual hosts by placing other directives inside the `<VIRTUALHOST>` containers. Most directives can be placed in these containers and will then change the configuration only of the relevant virtual host. To find out if a particular directive is allowed, check the Context (p. 299) of the directive. Configuration directives set in the *main server context* (outside any `<VIRTUALHOST>` container) will be used only if they are not overridden by the virtual host settings.

Now when a request arrives, the server will first check if it is using an IP address that matches the `NAMEVIRTUALHOST`. If it is, then it will look at each `<VIRTUALHOST>` section with a matching IP address and try to find one where the `SERVERNAME` or `ServerAlias` matches the requested hostname. If it finds one, then it uses the configuration for that server. If no matching virtual host is found, then **the first listed virtual host** that matches the IP address will be used.

As a consequence, the first listed virtual host is the *default* virtual host. The `DOCUMENTROOT` from the *main server* will **never** be used when an IP address matches the `NAMEVIRTUALHOST` directive. If you would like to have a special configuration for requests that do not match any particular virtual host, simply put that configuration in a `<VIRTUALHOST>` container and list it first in the configuration file.

Compatibility with Older Browsers

As mentioned earlier, there are some clients who do not send the required data for the name-based virtual hosts to work properly. These clients will always be sent the pages from the first virtual host listed for that IP address (the primary name-based virtual host).

⇒ How much older?

Please note that when we say older, we really do mean older. You are very unlikely to encounter one of these browsers in use today. All current versions of any browser send the `Host` header as required for name-based virtual hosts.

There is a possible workaround with the `SERVERPATH` directive, albeit a slightly cumbersome one:

Example configuration:

```
NameVirtualHost 111.22.33.44
<VirtualHost 111.22.33.44>
    ServerName www.domain.tld
    ServerPath /domain
    DocumentRoot /web/domain
</VirtualHost>
```

What does this mean? It means that a request for any URI beginning with `/domain` will be served from the virtual host `www.domain.tld`. This means that the pages can be accessed as `http://www.domain.tld/domain/` for all clients, although clients sending a `Host` header can also access it as `http://www.domain.tld/`.

In order to make this work, put a link on your primary virtual host's page to `http://www.domain.tld/domain/`. Then, in the virtual host's pages, be sure to use either purely relative links (e.g., `file.html` or `../icons/image.gif`) or links containing the prefacing `/domain/` (e.g., `http://www.domain.tld/domain/misc/file.html` or `/domain/misc/file.html`).

This requires a bit of discipline, but adherence to these guidelines will, for the most part, ensure that your pages will work with all browsers, new and old.

3.3 Apache IP-based Virtual Host Support

See also

- Name-based Virtual Hosts Support (p. 111)

System requirements

As the term IP-based indicates, the server **must have a different IP address for each IP-based virtual host**. This can be achieved by the machine having several physical network connections, or by use of virtual interfaces which are supported by most modern operating systems (see system documentation for details, these are frequently called "ip aliases", and the "ifconfig" command is most commonly used to set them up).

How to set up Apache

There are two ways of configuring apache to support multiple hosts. Either by running a separate httpd daemon for each hostname, or by running a single daemon which supports all the virtual hosts.

Use multiple daemons when:

- There are security partitioning issues, such as company1 does not want anyone at company2 to be able to read their data except via the web. In this case you would need two daemons, each running with different `USER`, `GROUP`, `LISTEN`, and `SERVERROOT` settings.
- You can afford the memory and file descriptor requirements (p. 291) of listening to every IP alias on the machine. It's only possible to `LISTEN` to the "wildcard" address, or to specific addresses. So if you have a need to listen to a specific address for whatever reason, then you will need to listen to all specific addresses. (Although one httpd could listen to N-1 of the addresses, and another could listen to the remaining address.)

Use a single daemon when:

- Sharing of the httpd configuration between virtual hosts is acceptable.
- The machine services a large number of requests, and so the performance loss in running separate daemons may be significant.

Setting up multiple daemons

Create a separate httpd installation for each virtual host. For each installation, use the `LISTEN` directive in the configuration file to select which IP address (or virtual host) that daemon services. e.g.

```
Listen www.smallco.com:80
```

It is recommended that you use an IP address instead of a hostname (see DNS caveats (p. 136)).

Setting up a single daemon with virtual hosts

For this case, a single httpd will service requests for the main server and all the virtual hosts. The `VIRTUALHOST` directive in the configuration file is used to set the values of `SERVERADMIN`, `SERVERNAME`, `DOCUMENTROOT`, `ERRORLOG` and `TRANSFERLOG` or `CUSTOMLOG` configuration directives to different values for each virtual host. e.g.

```
<VirtualHost www.smallco.com>
ServerAdmin webmaster@mail.smallco.com
DocumentRoot /groups/smallco/www
ServerName www.smallco.com
ErrorLog /groups/smallco/logs/error_log
TransferLog /groups/smallco/logs/access.log
</VirtualHost>

<VirtualHost www.baygroup.org>
ServerAdmin webmaster@mail.baygroup.org
DocumentRoot /groups/baygroup/www
ServerName www.baygroup.org
ErrorLog /groups/baygroup/logs/error_log
TransferLog /groups/baygroup/logs/access.log
</VirtualHost>
```

It is recommended that you use an IP address instead of a hostname (see [DNS caveats \(p. 136\)](#)).

Almost **any** configuration directive can be put in the `VirtualHost` directive, with the exception of directives that control process creation and a few other directives. To find out if a directive can be used in the `VirtualHost` directive, check the `Context` (p. [299](#)) using the `directive index` (p. [663](#)).

`SUEXECUSERGROUP` may be used inside a `VirtualHost` directive if the `suEXEC` wrapper (p. [68](#)) is used.

SECURITY: When specifying where to write log files, be aware of some security risks which are present if anyone other than the user that starts Apache has write access to the directory where they are written. See the `security tips` (p. [40](#)) document for details.

3.4 Dynamically Configured Mass Virtual Hosting

This document describes how to efficiently serve an arbitrary number of virtual hosts with the Apache httpd webserver.

Motivation

The techniques described here are of interest if your `httpd.conf` contains many `<VirtualHost>` sections that are substantially the same, for example:

```
NameVirtualHost 111.22.33.44
<VirtualHost 111.22.33.44>
    ServerName www.customer-1.com
    DocumentRoot /www/hosts/www.customer-1.com/docs
    ScriptAlias /cgi-bin/ /www/hosts/www.customer-1.com/cgi-bin
</VirtualHost>
<VirtualHost 111.22.33.44>
    ServerName www.customer-2.com
    DocumentRoot /www/hosts/www.customer-2.com/docs
    ScriptAlias /cgi-bin/ /www/hosts/www.customer-2.com/cgi-bin
</VirtualHost>
# blah blah blah
<VirtualHost 111.22.33.44>
    ServerName www.customer-N.com
    DocumentRoot /www/hosts/www.customer-N.com/docs
    ScriptAlias /cgi-bin/ /www/hosts/www.customer-N.com/cgi-bin
</VirtualHost>
```

The basic idea is to replace all of the static `<VirtualHost>` configurations with a mechanism that works them out dynamically. This has a number of advantages:

1. Your configuration file is smaller, so Apache starts more quickly and uses less memory.
2. Adding virtual hosts is simply a matter of creating the appropriate directories in the filesystem and entries in the DNS - you don't need to reconfigure or restart Apache.

The main disadvantage is that you cannot have a different log file for each virtual host; however, if you have many virtual hosts, doing this can be a bad idea anyway, because of the number of file descriptors needed. It is better to log to a pipe or a fifo, and arrange for the process at the other end to distribute the logs to the customers. (This can also be used to accumulate statistics, etc.).

Overview

A virtual host is defined by two pieces of information: its IP address, and the contents of the `Host:` header in the HTTP request. The dynamic mass virtual hosting technique used here is based on automatically inserting this information into the pathname of the file that is used to satisfy the request. This can be most easily done by using [MOD_VHOST_ALIAS](#) with Apache 2.0. Alternatively, [MOD_REWRITE](#) can be used. Both of these modules are disabled by default; you must enable one of them when configuring and building Apache if you want to use this technique.

A couple of things need to be 'faked' to make the dynamic virtual host look like a normal one. The most important is the server name, which is used by Apache to generate self-referential URLs etc. It is configured with the `ServerName` directive, and it is available to CGIs via the `SERVER_NAME` environment variable. The actual value

used at run time is controlled by the [USECANONICALNAME](#) setting. With `UseCanonicalName Off`, the server name is taken from the contents of the `Host :` header in the request. With `UseCanonicalName DNS`, it is taken from a reverse DNS lookup of the virtual host's IP address. The former setting is used for name-based dynamic virtual hosting, and the latter is used for IP-based hosting. If Apache cannot work out the server name because there is no `Host :` header, or the DNS lookup fails, then the value configured with `ServerName` is used instead.

The other thing to 'fake' is the document root (configured with `DocumentRoot` and available to CGIs via the `DOCUMENT_ROOT` environment variable). In a normal configuration, this is used by the core module when mapping URIs to filenames, but when the server is configured to do dynamic virtual hosting, that job must be taken over by another module (either `mod_vhost_alias` or `mod_rewrite`), which has a different way of doing the mapping. Neither of these modules is responsible for setting the `DOCUMENT_ROOT` environment variable so if any CGIs or SSI documents make use of it, they will get a misleading value.

Simple Dynamic Virtual Hosts

This extract from `httpd.conf` implements the virtual host arrangement outlined in the Motivation section above, but in a generic fashion using `mod_vhost_alias`.

```
# get the server name from the Host: header
UseCanonicalName Off

# this log format can be split per-virtual-host based on the first
field
LogFormat "%V %h %l %u %t \"%r\" %s %b" vcommon
CustomLog logs/access_log vcommon

# include the server name in the filenames used to satisfy requests
VirtualDocumentRoot /www/hosts/%0/docs
VirtualScriptAlias /www/hosts/%0/cgi-bin
```

This configuration can be changed into an IP-based virtual hosting solution by just turning `UseCanonicalName Off` into `UseCanonicalName DNS`. The server name that is inserted into the filename is then derived from the IP address of the virtual host.

A Virtually Hosted Homepages System

This is an adjustment of the above system, tailored for an ISP's homepages server. Using a slightly more complicated configuration, we can select substrings of the server name to use in the filename so that, for example, the documents for `www.user.isp.com` are found in `/home/user/`. It uses a single `cgi-bin` directory instead of one per virtual host.

```
# all the preliminary stuff is the same as above, then
# include part of the server name in the filenames
VirtualDocumentRoot /www/hosts/%2/docs

# single cgi-bin directory
ScriptAlias /cgi-bin/ /www/std-cgi/
```

There are examples of more complicated `VirtualDocumentRoot` settings in the [MOD_VHOST_ALIAS](#) documentation.

Using Multiple Virtual Hosting Systems on the Same Server

With more complicated setups, you can use Apache's normal `<VirtualHost>` directives to control the scope of the various virtual hosting configurations. For example, you could have one IP address for general customers' homepages, and another for commercial customers, with the following setup. This can, of course, be combined with conventional `<VirtualHost>` configuration sections.

```
UseCanonicalName Off
LogFormat "%V %h %l %u %t \"%r\" %s %b" vcommon
<Directory /www/commercial>
    Options FollowSymLinks
    AllowOverride All
</Directory>
<Directory /www/homepages>
    Options FollowSymLinks
    AllowOverride None
</Directory>
<VirtualHost 111.22.33.44>
    ServerName www.commercial.isp.com
    CustomLog logs/access.log.commercial vcommon
    VirtualDocumentRoot /www/commercial/%0/docs
    VirtualScriptAlias /www/commercial/%0/cgi-bin
</VirtualHost>
<VirtualHost 111.22.33.45>
    ServerName www.homepages.isp.com
    CustomLog logs/access.log.homepages vcommon
    VirtualDocumentRoot /www/homepages/%0/docs
    ScriptAlias /cgi-bin/ /www/std-cgi/
</VirtualHost>
```

More Efficient IP-Based Virtual Hosting

The configuration changes suggested to turn the first example into an IP-based virtual hosting setup result in a rather inefficient setup. A new DNS lookup is required for every request. To avoid this overhead, the filesystem can be arranged to correspond to the IP addresses, instead of to the host names, thereby negating the need for a DNS lookup. Logging will also have to be adjusted to fit this system.

```
# get the server name from the reverse DNS of the IP address
UseCanonicalName DNS
# include the IP address in the logs so they may be split
LogFormat "%A %h %l %u %t \"%r\" %s %b" vcommon
CustomLog logs/access.log vcommon
# include the IP address in the filenames
VirtualDocumentRootIP /www/hosts/%0/docs
VirtualScriptAliasIP /www/hosts/%0/cgi-bin
```

Simple Dynamic Virtual Hosts Using `MOD_REWRITE`

This extract from `httpd.conf` does the same thing as the first example. The first half is very similar to the corresponding part above, except for some changes, required for backward compatibility and to make the `mod_rewrite` part work properly; the second half configures `mod_rewrite` to do the actual work.

There are a couple of especially tricky bits: by default, `mod_rewrite` runs before other URI translation modules (`mod_alias` etc.) - so if you wish to use these modules, `mod_rewrite` must be configured to accommodate them. Also, some magic is required to do a per-dynamic-virtual-host equivalent of `ScriptAlias`.

```
# get the server name from the Host: header
UseCanonicalName Off

# splittable logs
LogFormat "%{Host}i %h %l %u %t \"%r\" %s %b" vcommon
CustomLog logs/access_log vcommon

<Directory /www/hosts>
    # ExecCGI is needed here because we can't force
    # CGI execution in the way that ScriptAlias does
    Options FollowSymLinks ExecCGI
</Directory>

# now for the hard bit
RewriteEngine On

# a ServerName derived from a Host: header may be any case at all
RewriteMap lowercase int:tolower

## deal with normal documents first:
# allow Alias /icons/ to work - repeat for other aliases
RewriteCond %{REQUEST_URI} !~/icons/
# allow CGIs to work
RewriteCond %{REQUEST_URI} !~/cgi-bin/
# do the magic
RewriteRule ^/(.*)$ /www/hosts/${lowercase:%{SERVER_NAME}}/docs/$1

## and now deal with CGIs - we have to force a MIME type
RewriteCond %{REQUEST_URI} ^/cgi-bin/
RewriteRule ^/(.*)$ /www/hosts/${lowercase:%{SERVER_NAME}}/cgi-bin/$1
[T=application/x-httpd-cgi]

# that's it!
```

A Homepages System Using `mod_rewrite`

This does the same thing as the second example.

```

RewriteEngine on
RewriteMap lowercase int:tolower
# allow CGIs to work
RewriteCond %{REQUEST_URI} !~/cgi-bin/
# check the hostname is right so that the RewriteRule works
RewriteCond ${lowercase:%{SERVER_NAME}} ^www\.[a-z-]+\\.isp\.com$
# concatenate the virtual host name onto the start of the URI
# the [C] means do the next rewrite on the result of this one
RewriteRule ^(.+) ${lowercase:%{SERVER_NAME}}$1 [C]
# now create the real file name
RewriteRule ^www\.[a-z-]+\\.isp\.com/(.*) /home/$1/$2
# define the global CGI directory
ScriptAlias /cgi-bin/ /www/std-cgi/

```

Using a Separate Virtual Host Configuration File

This arrangement uses more advanced `MOD_REWRITE` features to work out the translation from virtual host to document root, from a separate configuration file. This provides more flexibility, but requires more complicated configuration.

The `vhost.map` file should look something like this:

```

www.customer-1.com /www/customers/1
www.customer-2.com /www/customers/2
# ...
www.customer-N.com /www/customers/N

```

The `httpd.conf` should contain the following:

```

RewriteEngine on
RewriteMap lowercase int:tolower
# define the map file
RewriteMap vhost txt:/www/conf/vhost.map
# deal with aliases as above
RewriteCond %{REQUEST_URI} !~/icons/
RewriteCond %{REQUEST_URI} !~/cgi-bin/
RewriteCond ${lowercase:%{SERVER_NAME}} ^(.+)$
# this does the file-based remap
RewriteCond ${vhost:%1} ^(/.*)$
RewriteRule ^(/.*)$ %1/docs/$1
RewriteCond %{REQUEST_URI} ^/cgi-bin/
RewriteCond ${lowercase:%{SERVER_NAME}} ^(.+)$
RewriteCond ${vhost:%1} ^(/.*)$
RewriteRule ^(/.*)$ %1/cgi-bin/$1 [T=application/x-httpd-cgi]

```

3.5 VirtualHost Examples

This document attempts to answer the commonly-asked questions about setting up virtual hosts. These scenarios are those involving multiple web sites running on a single server, via name-based (p. 111) or IP-based (p. 114) virtual hosts.

Running several name-based web sites on a single IP address.

Your server has a single IP address, and multiple aliases (CNAMEs) point to this machine in DNS. You want to run a web server for `www.example1.com` and `www.example2.org` on this machine.

⇒ Note

Creating virtual host configurations on your Apache server does not magically cause DNS entries to be created for those host names. You *must* have the names in DNS, resolving to your IP address, or nobody else will be able to see your web site. You can put entries in your `hosts` file for local testing, but that will work only from the machine with those hosts entries.

Server configuration

```
# Ensure that Apache listens on port 80
Listen 80

# Listen for virtual host requests on all IP addresses
NameVirtualHost *:80

<VirtualHost *:80>
    DocumentRoot /www/example1
    ServerName www.example1.com
    # Other directives here
</VirtualHost>

<VirtualHost *:80>
    DocumentRoot /www/example2
    ServerName www.example2.org
    # Other directives here
</VirtualHost>
```

The asterisks match all addresses, so the main server serves no requests. Due to the fact that `www.example1.com` is first in the configuration file, it has the highest priority and can be seen as the default or primary server. That means that if a request is received that does not match one of the specified `ServerName` directives, it will be served by this first `VirtualHost`.

⇒ Note

You can, if you wish, replace `*` with the actual IP address of the system. In that case, the argument to `VirtualHost` *must* match the argument to `NameVirtualHost`:

```
NameVirtualHost 172.20.30.40
<VirtualHost 172.20.30.40>
# etc ...
```

However, it is additionally useful to use `*` on systems where the IP address is not predictable - for example if you have a dynamic IP address with your ISP, and you are using some variety of dynamic DNS solution. Since `*` matches any IP address, this configuration would work without changes whenever your IP address changes.

The above configuration is what you will want to use in almost all name-based virtual hosting situations. The only thing that this configuration will not work for, in fact, is when you are serving different content based on differing IP addresses or ports.

Name-based hosts on more than one IP address.

⇒ Note

Any of the techniques discussed here can be extended to any number of IP addresses.

The server has two IP addresses. On one (172.20.30.40), we will serve the "main" server, `server.domain.com` and on the other (172.20.30.50), we will serve two or more virtual hosts.

Server configuration

```
Listen 80

# This is the "main" server running on 172.20.30.40
ServerName server.domain.com
DocumentRoot /www/mainserver

# This is the other address
NameVirtualHost 172.20.30.50
<VirtualHost 172.20.30.50>
    DocumentRoot /www/example1
    ServerName www.example1.com
    # Other directives here ...
</VirtualHost>
<VirtualHost 172.20.30.50>
    DocumentRoot /www/example2
    ServerName www.example2.org
    # Other directives here ...
</VirtualHost>
```

Any request to an address other than 172.20.30.50 will be served from the main server. A request to 172.20.30.50 with an unknown hostname, or no `Host`: header, will be served from `www.example1.com`.

Serving the same content on different IP addresses (such as an internal and external address).

The server machine has two IP addresses (192.168.1.1 and 172.20.30.40). The machine is sitting between an internal (intranet) network and an external (internet) network. Outside of the network, the name `server.example.com` resolves to the external address (172.20.30.40), but inside the network, that same name resolves to the internal address (192.168.1.1).

The server can be made to respond to internal and external requests with the same content, with just one `VirtualHost` section.

Server configuration

```
NameVirtualHost 192.168.1.1
NameVirtualHost 172.20.30.40
<VirtualHost 192.168.1.1 172.20.30.40>
    DocumentRoot /www/server1
    ServerName server.example.com
    ServerAlias server
</VirtualHost>
```

Now requests from both networks will be served from the same `VirtualHost`.

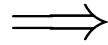
**Note:**

On the internal network, one can just use the name `server` rather than the fully qualified host name `server.example.com`.

Note also that, in the above example, you can replace the list of IP addresses with `*`, which will cause the server to respond the same on all addresses.

Running different sites on different ports.

You have multiple domains going to the same IP and also want to serve multiple ports. By defining the ports in the "NameVirtualHost" tag, you can allow this to work. If you try using `<VirtualHost name:port>` without the `NameVirtualHost name:port` or you try to use the `Listen` directive, your configuration will not work.

```
Server configuration
Listen 80
Listen 8080
NameVirtualHost 172.20.30.40:80
NameVirtualHost 172.20.30.40:8080
<VirtualHost 172.20.30.40:80>
    ServerName www.example1.com
    DocumentRoot /www/domain-80
</VirtualHost>
<VirtualHost 172.20.30.40:8080>
    ServerName www.example1.com
    DocumentRoot /www/domain-8080
</VirtualHost>
<VirtualHost 172.20.30.40:80>
    ServerName www.example2.org
    DocumentRoot /www/otherdomain-80
</VirtualHost>
<VirtualHost 172.20.30.40:8080>
    ServerName www.example2.org
    DocumentRoot /www/otherdomain-8080
</VirtualHost>
```

IP-based virtual hosting

The server has two IP addresses (172.20.30.40 and 172.20.30.50) which resolve to the names `www.example1.com` and `www.example2.org` respectively.

```

Server configuration
Listen 80
<VirtualHost 172.20.30.40>
    DocumentRoot /www/example1
    ServerName www.example1.com
</VirtualHost>
<VirtualHost 172.20.30.50>
    DocumentRoot /www/example2
    ServerName www.example2.org
</VirtualHost>

```

Requests for any address not specified in one of the `<VirtualHost>` directives (such as `localhost`, for example) will go to the main server, if there is one.

Mixed port-based and ip-based virtual hosts

The server machine has two IP addresses (172.20.30.40 and 172.20.30.50) which resolve to the names `www.example1.com` and `www.example2.org` respectively. In each case, we want to run hosts on ports 80 and 8080.

```

Server configuration
Listen 172.20.30.40:80
Listen 172.20.30.40:8080
Listen 172.20.30.50:80
Listen 172.20.30.50:8080
<VirtualHost 172.20.30.40:80>
    DocumentRoot /www/example1-80
    ServerName www.example1.com
</VirtualHost>
<VirtualHost 172.20.30.40:8080>
    DocumentRoot /www/example1-8080
    ServerName www.example1.com
</VirtualHost>
<VirtualHost 172.20.30.50:80>
    DocumentRoot /www/example2-80
    ServerName www.example1.org
</VirtualHost>
<VirtualHost 172.20.30.50:8080>
    DocumentRoot /www/example2-8080
    ServerName www.example2.org
</VirtualHost>

```

Mixed name-based and IP-based vhosts

On some of my addresses, I want to do name-based virtual hosts, and on others, IP-based hosts.

```

Server configuration
Listen 80
NameVirtualHost 172.20.30.40
<VirtualHost 172.20.30.40>
    DocumentRoot /www/example1
    ServerName www.example1.com
</VirtualHost>
<VirtualHost 172.20.30.40>
    DocumentRoot /www/example2
    ServerName www.example2.org
</VirtualHost>
<VirtualHost 172.20.30.40>
    DocumentRoot /www/example3
    ServerName www.example3.net
</VirtualHost>
# IP-based
<VirtualHost 172.20.30.50>
    DocumentRoot /www/example4
    ServerName www.example4.edu
</VirtualHost>
<VirtualHost 172.20.30.60>
    DocumentRoot /www/example5
    ServerName www.example5.gov
</VirtualHost>

```

Using `VirtualHost` and `mod_proxy` together

The following example allows a front-end machine to proxy a virtual host through to a server running on another machine. In the example, a virtual host of the same name is configured on a machine at `192.168.111.2`. The `PROXYPRESERVEHOST ON` directive is used so that the desired hostname is passed through, in case we are proxying multiple hostnames to a single machine.

```

<VirtualHost *:*>
ProxyPreserveHost On
ProxyPass / http://192.168.111.2
ProxyPassReverse / http://192.168.111.2/
ServerName hostname.example.com
</VirtualHost>

```

Using `_default_vhosts`

`_default_vhosts` for all ports

Catching *every* request to any unspecified IP address and port, *i.e.*, an address/port combination that is not used for any other virtual host.

Server configuration

```
<VirtualHost _default.:*>
    DocumentRoot /www/default
</VirtualHost>
```

Using such a default vhost with a wildcard port effectively prevents any request going to the main server.

A default vhost never serves a request that was sent to an address/port that is used for name-based vhosts. If the request contained an unknown or no `Host:` header it is always served from the primary name-based vhost (the vhost for that address/port appearing first in the configuration file).

You can use [ALIASMATCH](#) or [REWRITERULE](#) to rewrite any request to a single information page (or script).

`_default_` vhosts for different ports

Same as setup 1, but the server listens on several ports and we want to use a second `_default_` vhost for port 80.

Server configuration

```
<VirtualHost _default.:80>
    DocumentRoot /www/default80
    # ...
</VirtualHost>
<VirtualHost _default.:*>
    DocumentRoot /www/default
    # ...
</VirtualHost>
```

The default vhost for port 80 (which *must* appear before any default vhost with a wildcard port) catches all requests that were sent to an unspecified IP address. The main server is never used to serve a request.

`_default_` vhosts for one port

We want to have a default vhost for port 80, but no other default vhosts.

Server configuration

```
<VirtualHost _default.:80>
    DocumentRoot /www/default
    ...
</VirtualHost>
```

A request to an unspecified address on port 80 is served from the default vhost any other request to an unspecified address and port is served from the main server.

Migrating a name-based vhost to an IP-based vhost

The name-based vhost with the hostname `www.example2.org` (from our name-based example, setup 2) should get its own IP address. To avoid problems with name servers or proxies who cached the old IP address for the name-based vhost we want to provide both variants during a migration phase.

The solution is easy, because we can simply add the new IP address (`172.20.30.50`) to the `VirtualHost` directive.

```

Server configuration
Listen 80
ServerName www.example1.com
DocumentRoot /www/example1
NameVirtualHost 172.20.30.40
<VirtualHost 172.20.30.40 172.20.30.50>
    DocumentRoot /www/example2
    ServerName www.example2.org
    # ...
</VirtualHost>
<VirtualHost 172.20.30.40>
    DocumentRoot /www/example3
    ServerName www.example3.net
    ServerAlias *.example3.net
    # ...
</VirtualHost>

```

The vhost can now be accessed through the new address (as an IP-based vhost) and through the old address (as a name-based vhost).

Using the `ServerPath` directive

We have a server with two name-based vhosts. In order to match the correct virtual host a client must send the correct `Host:` header. Old HTTP/1.0 clients do not send such a header and Apache has no clue what vhost the client tried to reach (and serves the request from the primary vhost). To provide as much backward compatibility as possible we create a primary vhost which returns a single page containing links with an URL prefix to the name-based virtual hosts.

```

Server configuration
NameVirtualHost 172.20.30.40
<VirtualHost 172.20.30.40>
    # primary vhost
    DocumentRoot /www/subdomain
    RewriteEngine On
    RewriteRule ^/.*/www/subdomain/index.html
    # ...
</VirtualHost>
<VirtualHost 172.20.30.40>
DocumentRoot /www/subdomain/sub1
    ServerName www.sub1.domain.tld
    ServerPath /sub1/
    RewriteEngine On
    RewriteRule ^(/sub1/.*) /www/subdomain$1
    # ...
</VirtualHost>
<VirtualHost 172.20.30.40>
    DocumentRoot /www/subdomain/sub2
    ServerName www.sub2.domain.tld
    ServerPath /sub2/
    RewriteEngine On
    RewriteRule ^(/sub2/.*) /www/subdomain$1
    # ...
</VirtualHost>

```

Due to the `SERVERPATH` directive a request to the URL `http://www.sub1.domain.tld/sub1/` is *always* served from the `sub1-vhost`.

A request to the URL `http://www.sub1.domain.tld/` is only served from the `sub1-vhost` if the client sent a correct `Host :` header. If no `Host :` header is sent the client gets the information page from the primary host.

Please note that there is one oddity: A request to `http://www.sub2.domain.tld/sub1/` is also served from the `sub1-vhost` if the client sent no `Host :` header.

The `REWRITERULE` directives are used to make sure that a client which sent a correct `Host :` header can use both URL variants, *i.e.*, with or without URL prefix.

3.6 An In-Depth Discussion of Virtual Host Matching

The virtual host code was completely rewritten in **Apache 1.3**. This document attempts to explain exactly what Apache does when deciding what virtual host to serve a hit from. With the help of the new `NAMEVIRTUALHOST` directive virtual host configuration should be a lot easier and safer than with versions prior to 1.3.

If you just want to make it work without understanding how, here are some examples (p. 121).

Config File Parsing

There is a *main_server* which consists of all the definitions appearing outside of `<VirtualHost>` sections. There are virtual servers, called *vhosts*, which are defined by `<VIRTUALHOST>` sections.

The directives `LISTEN`, `SERVERNAME`, `SERVERPATH`, and `SERVERALIAS` can appear anywhere within the definition of a server. However, each appearance overrides the previous appearance (within that server).

The default value of the `Listen` field for *main_server* is 80. The *main_server* has no default `ServerPath`, or `ServerAlias`. The default `ServerName` is deduced from the server's IP address.

The *main_server* `Listen` directive has two functions. One function is to determine the default network port Apache will bind to. The second function is to specify the port number which is used in absolute URIs during redirects.

Unlike the *main_server*, *vhost* ports *do not* affect what ports Apache listens for connections on.

Each address appearing in the `VirtualHost` directive can have an optional port. If the port is unspecified it defaults to the value of the *main_server*'s most recent `Listen` statement. The special port `*` indicates a wildcard that matches any port. Collectively the entire set of addresses (including multiple `A` record results from DNS lookups) are called the *vhost's address set*.

Unless a `NAMEVIRTUALHOST` directive is used for a specific IP address the first *vhost* with that address is treated as an IP-based *vhost*. The IP address can also be the wildcard `*`.

If name-based *vhosts* should be used a `NameVirtualHost` directive *must* appear with the IP address set to be used for the name-based *vhosts*. In other words, you must specify the IP address that holds the hostname aliases (CNAMEs) for your name-based *vhosts* via a `NameVirtualHost` directive in your configuration file.

Multiple `NameVirtualHost` directives can be used each with a set of `VirtualHost` directives but only one `NameVirtualHost` directive should be used for each specific IP:port pair.

The ordering of `NameVirtualHost` and `VirtualHost` directives is not important which makes the following two examples identical (only the order of the `VirtualHost` directives for *one* address set is important, see below):

```

NameVirtualHost 111.22.33.44
<VirtualHost 111.22.33.44>
# server A
...
</VirtualHost>
<VirtualHost 111.22.33.44>
# server B
...
</VirtualHost>
NameVirtualHost 111.22.33.55
<VirtualHost 111.22.33.55>
# server C
...
</VirtualHost>
<VirtualHost 111.22.33.55>
# server D
...
</VirtualHost>

```

```

<VirtualHost 111.22.33.44>
# server A
</VirtualHost>
<VirtualHost 111.22.33.55>
# server C
...
</VirtualHost>
<VirtualHost 111.22.33.44>
# server B
...
</VirtualHost>
<VirtualHost 111.22.33.55>
# server D
...
</VirtualHost>
NameVirtualHost 111.22.33.44
NameVirtualHost 111.22.33.55

```

(To aid the readability of your configuration you should prefer the left variant.)

After parsing the `VirtualHost` directive, the vhost server is given a default `Listen` equal to the port assigned to the first name in its `VirtualHost` directive.

The complete list of names in the `VirtualHost` directive are treated just like a `ServerAlias` (but are not overridden by any `ServerAlias` statement) if all names resolve to the same address set. Note that subsequent `Listen` statements for this vhost will not affect the ports assigned in the address set.

During initialization a list for each IP address is generated and inserted into an hash table. If the IP address is used in a `NameVirtualHost` directive the list contains all name-based vhosts for the given IP address. If there are no vhosts defined for that address the `NameVirtualHost` directive is ignored and an error is logged. For an IP-based vhost the list in the hash table is empty.

Due to a fast hashing function the overhead of hashing an IP address during a request is minimal and almost not existent. Additionally the table is optimized for IP addresses which vary in the last octet.

For every vhost various default values are set. In particular:

1. If a vhost has no `SERVERADMIN`, `RESOURCECONFIG`, `ACCESSCONFIG`, `TIMEOUT`, `KEEPALIVETIMEOUT`, `KEEPALIVE`, `MAXKEEPALIVEREQUESTS`, `RECEIVEBUFFERSIZE`, or `SENDERBUFFERSIZE` directive then the respective value is inherited from the `main_server`. (That is, inherited from whatever the final setting of that value is in the `main_server`.)
2. The "lookup defaults" that define the default directory permissions for a vhost are merged with those of the `main_server`. This includes any per-directory configuration information for any module.
3. The per-server configs for each module from the `main_server` are merged into the vhost server.

Essentially, the `main_server` is treated as "defaults" or a "base" on which to build each vhost. But the positioning of these `main_server` definitions in the config file is largely irrelevant – the entire config of the `main_server` has been parsed when this final merging occurs. So even if a `main_server` definition appears after a vhost definition it might affect the vhost definition.

If the `main_server` has no `ServerName` at this point, then the hostname of the machine that `httpd` is running on is used instead. We will call the *main_server address set* those IP addresses returned by a DNS lookup on the `ServerName` of the `main_server`.

For any undefined `ServerName` fields, a name-based vhost defaults to the address given first in the `VirtualHost` statement defining the vhost.

Any vhost that includes the magic `_default_` wildcard is given the same `ServerName` as the `main_server`.

Virtual Host Matching

The server determines which vhost to use for a request as follows:

Hash table lookup

When the connection is first made by a client, the IP address to which the client connected is looked up in the internal IP hash table.

If the lookup fails (the IP address wasn't found) the request is served from the `_default_` vhost if there is such a vhost for the port to which the client sent the request. If there is no matching `_default_` vhost the request is served from the `main_server`.

If the IP address is not found in the hash table then the match against the port number may also result in an entry corresponding to a `NameVirtualHost *`, which is subsequently handled like other name-based vhosts.

If the lookup succeeded (a corresponding list for the IP address was found) the next step is to decide if we have to deal with an IP-based or a name-base vhost.

IP-based vhost

If the entry we found has an empty name list then we have found an IP-based vhost, no further actions are performed and the request is served from that vhost.

Name-based vhost

If the entry corresponds to a name-based vhost the name list contains one or more vhost structures. This list contains the vhosts in the same order as the `VirtualHost` directives appear in the config file.

The first vhost on this list (the first vhost in the config file with the specified IP address) has the highest priority and catches any request to an unknown server name or a request without a `Host :` header field.

If the client provided a `Host :` header field the list is searched for a matching vhost and the first hit on a `ServerName` or `ServerAlias` is taken and the request is served from that vhost. A `Host :` header field can contain a port number, but Apache always matches against the real port to which the client sent the request.

If the client submitted a HTTP/1.0 request without `Host :` header field we don't know to what server the client tried to connect and any existing `ServerPath` is matched against the URI from the request. The first matching path on the list is used and the request is served from that vhost.

If no matching vhost could be found the request is served from the first vhost with a matching port number that is on the list for the IP to which the client connected (as already mentioned before).

Persistent connections

The IP lookup described above is only done *once* for a particular TCP/IP session while the name lookup is done *every* request during a `KeepAlive`/persistent connection. In other words a client may request pages from different name-based vhosts during a single persistent connection.

Absolute URI

If the URI from the request is an absolute URI, and its hostname and port match the main server or one of the configured virtual hosts *and* match the address and port to which the client sent the request, then the scheme/hostname/port prefix is stripped off and the remaining relative URI is served by the corresponding main server or virtual host. If it does not match, then the URI remains untouched and the request is taken to be a proxy request.

Observations

- A name-based vhost can never interfere with an IP-base vhost and vice versa. IP-based vhosts can only be reached through an IP address of its own address set and never through any other address. The same applies to name-based vhosts, they can only be reached through an IP address of the corresponding address set which must be defined with a `NameVirtualHost` directive.
- `ServerAlias` and `ServerPath` checks are never performed for an IP-based vhost.
- The order of name-/IP-based, the `_default_` vhost and the `NameVirtualHost` directive within the config file is not important. Only the ordering of name-based vhosts for a specific address set is significant. The one name-based vhosts that comes first in the configuration file has the highest priority for its corresponding address set.
- For security reasons the port number given in a `Host :` header field is never used during the matching process. Apache always uses the real port to which the client sent the request.
- If a `ServerPath` directive exists which is a prefix of another `ServerPath` directive that appears later in the configuration file, then the former will always be matched and the latter will never be matched. (That is assuming that no `Host :` header field was available to disambiguate the two.)
- If two IP-based vhosts have an address in common, the vhost appearing first in the config file is always matched. Such a thing might happen inadvertently. The server will give a warning in the error logfile when it detects this.
- A `_default_` vhost catches a request only if there is no other vhost with a matching IP address *and* a matching port number for the request. The request is only caught if the port number to which the client sent the request matches the port number of your `_default_` vhost which is your standard `Listen` by default. A wildcard port can be specified (*i.e.*, `_default_:*`) to catch requests to any available port. This also applies to `NameVirtualHost *` vhosts.
- The `main_server` is only used to serve a request if the IP address and port number to which the client connected is unspecified and does not match any other vhost (including a `_default_` vhost). In other words the `main_server` only catches a request for an unspecified address/port combination (unless there is a `_default_` vhost which matches that port).
- A `_default_` vhost or the `main_server` is *never* matched for a request with an unknown or missing `Host :` header field if the client connected to an address (and port) which is used for name-based vhosts, *e.g.*, in a `NameVirtualHost` directive.
- You should never specify DNS names in `VirtualHost` directives because it will force your server to rely on DNS to boot. Furthermore it poses a security threat if you do not control the DNS for all the domains listed. There's more information (p. 136) available on this and the next two topics.
- `ServerName` should always be set for each vhost. Otherwise A DNS lookup is required for each vhost.

Tips

In addition to the tips on the DNS Issues (p. 136) page, here are some further tips:

- Place all `main_server` definitions before any `VirtualHost` definitions. (This is to aid the readability of the configuration – the post-config merging process makes it non-obvious that definitions mixed in around virtual hosts might affect all virtual hosts.)

- Group corresponding `NameVirtualHost` and `VirtualHost` definitions in your configuration to ensure better readability.
- Avoid `ServerPaths` which are prefixes of other `ServerPaths`. If you cannot avoid this then you have to ensure that the longer (more specific) prefix vhost appears earlier in the configuration file than the shorter (less specific) prefix (*i.e.*, "`ServerPath /abc`" should appear after "`ServerPath /abc/def`").

3.7 File Descriptor Limits

When using a large number of Virtual Hosts, Apache may run out of available file descriptors (sometimes called file handles) if each Virtual Host specifies different log files. The total number of file descriptors used by Apache is one for each distinct error log file, one for every other log file directive, plus 10-20 for internal use. Unix operating systems limit the number of file descriptors that may be used by a process; the limit is typically 64, and may usually be increased up to a large hard-limit.

Although Apache attempts to increase the limit as required, this may not work if:

1. Your system does not provide the `setrlimit()` system call.
2. The `setrlimit(RLIMIT_NOFILE)` call does not function on your system (such as Solaris 2.3)
3. The number of file descriptors required exceeds the hard limit.
4. Your system imposes other limits on file descriptors, such as a limit on stdio streams only using file descriptors below 256. (Solaris 2)

In the event of problems you can:

- Reduce the number of log files; don't specify log files in the `<VIRTUALHOST>` sections, but only log to the main log files. (See [Splitting up your log files](#), below, for more information on doing this.)
- If your system falls into 1 or 2 (above), then increase the file descriptor limit before starting Apache, using a script like

```
#!/bin/sh
ulimit -S -n 100
exec httpd
```

Please see the [Descriptors and Apache](#) (p. 291) document containing further details about file descriptor problems and how they can be solved on your operating system.

Splitting up your log files

If you want to log multiple virtual hosts to the same log file, you may want to split up the log files afterwards in order to run statistical analysis of the various virtual hosts. This can be accomplished in the following manner.

First, you will need to add the virtual host information to the log entries. This can be done using the `LOGFORMAT` directive, and the `%v` variable. Add this to the beginning of your log format string:

```
LogFormat "%v %h %l %u %t \"%r\" %>s %b" vhost
CustomLog logs/multiple_vhost_log vhost
```

This will create a log file in the common log format, but with the canonical virtual host (whatever appears in the `SERVERNAME` directive) prepended to each line. (See [CUSTOM LOG FORMATS](#) for more about customizing your log files.)

When you wish to split your log file into its component parts (one file per virtual host) you can use the program `split-logfile` (p. 269) to accomplish this. You'll find this program in the support directory of the Apache distribution.

Run this program with the command:

```
split-logfile < /logs/multiple_vhost.log
```

This program, when run with the name of your vhost log file, will generate one file for each virtual host that appears in your log file. Each file will be called `hostname.log`.

3.8 Issues Regarding DNS and Apache

This page could be summarized with the statement: don't configure Apache in such a way that it relies on DNS resolution for parsing of the configuration files. If Apache requires DNS resolution to parse the configuration files then your server may be subject to reliability problems (ie. it might not boot), or denial and theft of service attacks (including users able to steal hits from other users).

A Simple Example

```
<VirtualHost www.abc.dom>
ServerAdmin webgirl@abc.dom
DocumentRoot /www/abc
</VirtualHost>
```

In order for Apache to function properly, it absolutely needs to have two pieces of information about each virtual host: the `SERVERNAME` and at least one IP address that the server will bind and respond to. The above example does not include the IP address, so Apache must use DNS to find the address of `www.abc.dom`. If for some reason DNS is not available at the time your server is parsing its config file, then this virtual host **will not be configured**. It won't be able to respond to any hits to this virtual host (prior to Apache version 1.2 the server would not even boot).

Suppose that `www.abc.dom` has address `10.0.0.1`. Then consider this configuration snippet:

```
<VirtualHost 10.0.0.1>
ServerAdmin webgirl@abc.dom
DocumentRoot /www/abc
</VirtualHost>
```

This time Apache needs to use reverse DNS to find the `ServerName` for this virtualhost. If that reverse lookup fails then it will partially disable the virtualhost (prior to Apache version 1.2 the server would not even boot). If the virtual host is name-based then it will effectively be totally disabled, but if it is IP-based then it will mostly work. However, if Apache should ever have to generate a full URL for the server which includes the server name, then it will fail to generate a valid URL.

Here is a snippet that avoids both of these problems:

```
<VirtualHost 10.0.0.1>
ServerName www.abc.dom
ServerAdmin webgirl@abc.dom
DocumentRoot /www/abc
</VirtualHost>
```

Denial of Service

There are (at least) two forms that denial of service can come in. If you are running a version of Apache prior to version 1.2 then your server will not even boot if one of the two DNS lookups mentioned above fails for any of your virtual hosts. In some cases this DNS lookup may not even be under your control; for example, if `abc.dom` is one of your customers and they control their own DNS, they can force your (pre-1.2) server to fail while booting simply by deleting the `www.abc.dom` record.

Another form is far more insidious. Consider this configuration snippet:

```

<VirtualHost www.abc.dom>
ServerAdmin webgirl@abc.dom
DocumentRoot /www/abc
</VirtualHost>

<VirtualHost www.def.dom>
ServerAdmin webguy@def.dom
DocumentRoot /www/def
</VirtualHost>

```

Suppose that you've assigned 10.0.0.1 to `www.abc.dom` and 10.0.0.2 to `www.def.dom`. Furthermore, suppose that `def.dom` has control of their own DNS. With this config you have put `def.dom` into a position where they can steal all traffic destined to `abc.dom`. To do so, all they have to do is set `www.def.dom` to 10.0.0.1. Since they control their own DNS you can't stop them from pointing the `www.def.dom` record wherever they wish.

Requests coming in to 10.0.0.1 (including all those where users typed in URLs of the form `http://www.abc.dom/whatever`) will all be served by the `def.dom` virtual host. To better understand why this happens requires a more in-depth discussion of how Apache matches up incoming requests with the virtual host that will serve it. A rough document describing this is available (p. 129).

The "main server" Address

The addition of name-based virtual host support (p. 111) in Apache 1.1 requires Apache to know the IP address(es) of the host that `httpd` is running on. To get this address it uses either the global `SERVERNAME` (if present) or calls the C function `gethostname` (which should return the same as typing "hostname" at the command prompt). Then it performs a DNS lookup on this address. At present there is no way to avoid this lookup.

If you fear that this lookup might fail because your DNS server is down then you can insert the hostname in `/etc/hosts` (where you probably already have it so that the machine can boot properly). Then ensure that your machine is configured to use `/etc/hosts` in the event that DNS fails. Depending on what OS you are using this might be accomplished by editing `/etc/resolv.conf`, or maybe `/etc/nsswitch.conf`.

If your server doesn't have to perform DNS for any other reason then you might be able to get away with running Apache with the `HOSTRESORDER` environment variable set to "local". This all depends on what OS and resolver libraries you are using. It also affects CGIs unless you use `MOD_ENV` to control the environment. It's best to consult the man pages or FAQs for your OS.

Tips to Avoid These Problems

- use IP addresses in `VIRTUALHOST`
- use IP addresses in `LISTEN`
- ensure all virtual hosts have an explicit `SERVERNAME`
- create a `<VirtualHost _default_:*>` server that has no pages to serve

Appendix: Future Directions

The situation regarding DNS is highly undesirable. For Apache 1.2 we've attempted to make the server at least continue booting in the event of failed DNS, but it might not be the best we can do. In any event, requiring the use of explicit IP addresses in configuration files is highly undesirable in today's Internet where renumbering is a necessity.

A possible work around to the theft of service attack described above would be to perform a reverse DNS lookup on the IP address returned by the forward lookup and compare the two names – in the event of a mismatch, the virtualhost

would be disabled. This would require reverse DNS to be configured properly (which is something that most admins are familiar with because of the common use of "double-reverse" DNS lookups by FTP servers and TCP wrappers).

In any event, it doesn't seem possible to reliably boot a virtual-hosted web server when DNS has failed unless IP addresses are used. Partial solutions such as disabling portions of the configuration might be worse than not booting at all depending on what the webserver is supposed to accomplish.

As HTTP/1.1 is deployed and browsers and proxies start issuing the `Host` header it will become possible to avoid the use of IP-based virtual hosts entirely. In this case, a webserver has no requirement to do DNS lookups during configuration. But as of March 1997 these features have not been deployed widely enough to be put into use on critical webservers.

Chapter 4

Apache Server Frequently Asked Questions

4.1 Frequently Asked Questions

The latest version of this FAQ is always available from the main Apache web site, at <http://httpd.apache.org/docs/2.0/faq/>. In addition, you can view this FAQ all in one page (p. ??) for easy searching and printing.

Since Apache 2.0 is quite new, we don't yet know what the *Frequently Asked Questions* will be. While this section fills up, you should also consult the Apache 1.3 FAQ¹ to see if your question is answered there.

¹<http://httpd.apache.org/docs/misc/FAQ.html>

4.2 Support - Frequently Asked Questions

Support

- "Why can't I ...? Why won't ... work?" What to do in case of problems
- Whom do I contact for support?

"Why can't I ...? Why won't ... work?" What to do in case of problems

If you are having trouble with your Apache server software, you should take the following steps:

Check the errorlog! Apache tries to be helpful when it encounters a problem. In many cases, it will provide some details by writing one or messages to the server error log. Sometimes this is enough for you to diagnose & fix the problem yourself (such as file permissions or the like). The default location of the error log is `/usr/local/apache2/logs/error_log`, but see the [ERRORLOG](#) directive in your config files for the location on your server.

Check the FAQ²! The latest version of the Apache Frequently-Asked Questions list can always be found at the main Apache web site.

Check the Apache bug database Most problems that get reported to The Apache Group are recorded in the bug database³. **Please** check the existing reports, open **and** closed, before adding one. If you find that your issue has already been reported, please *don't* add a "me, too" report. If the original report isn't closed yet, we suggest that you check it periodically. You might also consider contacting the original submitter, because there may be an email exchange going on about the issue that isn't getting recorded in the database.

Ask in a user support forum Apache has an active community of users who are willing to share their knowledge. Participating in this community is usually the best and fastest way to get answers to your questions and problems.

Users mailing list⁴

USENET newsgroups:

- comp.infosystems.www.servers.unix [news⁵] [google⁶]
- comp.infosystems.www.servers.ms-windows [news⁷] [google⁸]
- comp.infosystems.www.authoring.cgi [news⁹] [google¹⁰]

If all else fails, report the problem in the bug database If you've gone through those steps above that are appropriate and have obtained no relief, then please *do* let the httpd developers know about the problem by logging a bug report¹¹.

If your problem involves the server crashing and generating a core dump, please include a backtrace (if possible). As an example,

```
# cd ServerRoot
# dbx httpd core
(dbx) where
```

³http://httpd.apache.org/bug_report.html

⁴<http://httpd.apache.org/userslist.html>

⁵[news:comp.infosystems.www.servers.unix](mailto:comp.infosystems.www.servers.unix)

⁶<http://groups.google.com/groups?group=comp.infosystems.www.servers.unix>

⁷[news:comp.infosystems.www.servers.ms-windows](mailto:comp.infosystems.www.servers.ms-windows)

⁸<http://groups.google.com/groups?group=comp.infosystems.www.servers.ms-windows>

⁹[news:comp.infosystems.www.authoring.cgi](mailto:comp.infosystems.www.authoring.cgi)

¹⁰<http://groups.google.com/groups?group=comp.infosystems.www.authoring.cgi>

¹¹http://httpd.apache.org/bug_report.html

(Substitute the appropriate locations for your ServerRoot and your httpd and core files. You may have to use gdb instead of dbx.)

Whom do I contact for support?

With several million users and fewer than forty volunteer developers, we cannot provide personal support for Apache. For free support, we suggest participating in a user forum.

Professional, commercial support for Apache is available from a number of companies¹².

¹²<http://www.apache.org/info/support.cgi>

4.3 Error Messages - Frequently Asked Questions

Error Messages

- Invalid argument: core_output_filter: writing data to the network
- AcceptEx failed
- Premature end of script headers

Invalid argument: core_output_filter: writing data to the network

Apache uses the `sendfile` syscall on platforms where it is available in order to speed sending of responses. Unfortunately, on some systems, Apache will detect the presence of `sendfile` at compile-time, even when it does not work properly. This happens most frequently when using network or other non-standard file-system.

Symptoms of this problem include the above message in the error log and zero-length responses to non-zero-sized files. The problem generally occurs only for static files, since dynamic content usually does not make use of `sendfile`.

To fix this problem, simply use the [ENABLESENDFILE](#) directive to disable `sendfile` for all or part of your server. Also see the [ENABLEMMAP](#), which can help with similar problems.

AcceptEx Failed

If you get error messages related to the `AcceptEx` syscall on win32, see the [WIN32DISABLEACCEPTEX](#) directive.

Premature end of script headers

Most problems with CGI scripts result in this message written in the error log together with an `Internal Server Error` delivered to the browser. A guide to helping debug this type of problem is available in the CGI tutorial (p. [185](#)).

Chapter 5

Apache SSL/TLS Encryption

5.1 Apache SSL/TLS Encryption

The Apache HTTP Server module `MOD_SSL` provides an interface to the OpenSSL¹ library, which provides Strong Encryption using the Secure Sockets Layer and Transport Layer Security protocols. The module and this documentation are based on Ralf S. Engelschall's `mod_ssl` project.

Documentation

- Introduction (p. 147)
- Compatibility (p. 156)
- How-To (p. 160)
- Frequently Asked Questions (p. 165)
- Glossary (p. 656)

`mod_ssl`

Extensive documentation on the directives and environment variables provided by this module is provided in the `mod_ssl` reference documentation (p. 549) .

¹<http://www.openssl.org/>

5.2 SSL/TLS Strong Encryption: An Introduction

The nice thing about standards is that there are so many to choose from. And if you really don't like all the standards you just have to wait another year until the one arises you are looking for.

– A. Tanenbaum, "Introduction to Computer Networks"

As an introduction this chapter is aimed at readers who are familiar with the Web, HTTP, and Apache, but are not security experts. It is not intended to be a definitive guide to the SSL protocol, nor does it discuss specific techniques for managing certificates in an organization, or the important legal issues of patents and import and export restrictions. Rather, it is intended to provide a common background to mod_ssl users by pulling together various concepts, definitions, and examples as a starting point for further exploration.

The presented content is mainly derived, with permission by the author, from the article *Introducing SSL and Certificates using SSLey*² from Frederick J. Hirsch³, of The Open Group Research Institute, which was published in *Web Security: A Matter of Trust*⁴, World Wide Web Journal, Volume 2, Issue 3, Summer 1997. Please send any positive feedback to Frederick Hirsch⁵ (the original article author) and all negative feedback to Ralf S. Engelschall⁶ (the MOD_SSL author).

Cryptographic Techniques

Understanding SSL requires an understanding of cryptographic algorithms, message digest functions (aka. one-way or hash functions), and digital signatures. These techniques are the subject of entire books (see for instance [AC96]) and provide the basis for privacy, integrity, and authentication.

Cryptographic Algorithms

Suppose Alice wants to send a message to her bank to transfer some money. Alice would like the message to be private, since it will include information such as her account number and transfer amount. One solution is to use a cryptographic algorithm, a technique that would transform her message into an encrypted form, unreadable except by those it is intended for. Once in this form, the message may only be interpreted through the use of a secret key. Without the key the message is useless: good cryptographic algorithms make it so difficult for intruders to decode the original text that it isn't worth their effort.

There are two categories of cryptographic algorithms: conventional and public key.

Conventional cryptography also known as symmetric cryptography, requires the sender and receiver to share a key: a secret piece of information that may be used to encrypt or decrypt a message. If this key is secret, then nobody other than the sender or receiver may read the message. If Alice and the bank know a secret key, then they may send each other private messages. The task of privately choosing a key before communicating, however, can be problematic.

Public key cryptography also known as asymmetric cryptography, solves the key exchange problem by defining an algorithm which uses two keys, each of which may be used to encrypt a message. If one key is used to encrypt a message then the other must be used to decrypt it. This makes it possible to receive secure messages by simply publishing one key (the public key) and keeping the other secret (the private key).

Anyone may encrypt a message using the public key, but only the owner of the private key will be able to read it. In this way, Alice may send private messages to the owner of a key-pair (the bank), by encrypting it using their public key. Only the bank will be able to decrypt it.

²<http://home.earthlink.net/~fjhirsch/Papers/wwwj/article.html>

³<http://home.earthlink.net/~fjhirsch/>

⁴<http://www.ora.com/catalog/wjsum97/>

⁵<mailto:hirsch@fjhirsch.com>

⁶<mailto:rse@engelschall.com>

Message Digests

Although Alice may encrypt her message to make it private, there is still a concern that someone might modify her original message or substitute it with a different one, in order to transfer the money to themselves, for instance. One way of guaranteeing the integrity of Alice's message is to create a concise summary of her message and send this to the bank as well. Upon receipt of the message, the bank creates its own summary and compares it with the one Alice sent. If they agree then the message was received intact.

A summary such as this is called a message digest, *one-way function* or *hash function*. Message digests are used to create short, fixed-length representations of longer, variable-length messages. Digest algorithms are designed to produce unique digests for different messages. Message digests are designed to make it too difficult to determine the message from the digest, and also impossible to find two different messages which create the same digest – thus eliminating the possibility of substituting one message for another while maintaining the same digest.

Another challenge that Alice faces is finding a way to send the digest to the bank securely; when this is achieved, the integrity of the associated message is assured. One way to do this is to include the digest in a digital signature.

Digital Signatures

When Alice sends a message to the bank, the bank needs to ensure that the message is really from her, so an intruder does not request a transaction involving her account. A *digital signature*, created by Alice and included with the message, serves this purpose.

Digital signatures are created by encrypting a digest of the message, and other information (such as a sequence number) with the sender's private key. Though anyone may *decrypt* the signature using the public key, only the signer knows the private key. This means that only they may have signed it. Including the digest in the signature means the signature is only good for that message; it also ensures the integrity of the message since no one can change the digest and still sign it.

To guard against interception and reuse of the signature by an intruder at a later date, the signature contains a unique sequence number. This protects the bank from a fraudulent claim from Alice that she did not send the message – only she could have signed it (non-repudiation).

Certificates

Although Alice could have sent a private message to the bank, signed it, and ensured the integrity of the message, she still needs to be sure that she is really communicating with the bank. This means that she needs to be sure that the public key she is using corresponds to the bank's private key. Similarly, the bank also needs to verify that the message signature really corresponds to Alice's signature.

If each party has a certificate which validates the other's identity, confirms the public key, and is signed by a trusted agency, then they both will be assured that they are communicating with whom they think they are. Such a trusted agency is called a *Certificate Authority*, and certificates are used for authentication.

Certificate Contents

A certificate associates a public key with the real identity of an individual, server, or other entity, known as the subject. As shown in Table 1, information about the subject includes identifying information (the distinguished name), and the public key. It also includes the identification and signature of the Certificate Authority that issued the certificate, and the period of time during which the certificate is valid. It may have additional information (or extensions) as well as administrative information for the Certificate Authority's use, such as a serial number.

Table 1: Certificate Information

Subject	Distinguished Name, Public Key
Issuer	Distinguished Name, Signature
Period of Validity	Not Before Date, Not After Date
Administrative Information	Version, Serial Number
Extended Information	Basic Constraints, Netscape Flags, etc.

A distinguished name is used to provide an identity in a specific context – for instance, an individual might have a personal certificate as well as one for their identity as an employee. Distinguished names are defined by the X.509 standard [X509], which defines the fields, field names, and abbreviations used to refer to the fields (see Table 2).

Table 2: Distinguished Name Information

DN Field	Abbrev.	Description	Example
Common Name	CN	Name being certified	CN=Joe Average
Organization or Company	O	Name is associated with this organization	O=Snake Oil, Ltd.
Organizational Unit	OU	Name is associated with this organization unit, such as a department	OU=Research Institute
City/Locality	L	Name is located in this City	L=Snake City
State/Province	ST	Name is located in this State/Province	ST=Desert
Country	C	Name is located in this Country (ISO code)	C=XZ

A Certificate Authority may define a policy specifying which distinguished field names are optional, and which are required. It may also place requirements upon the field contents, as may users of certificates. As an example, a Netscape browser requires that the Common Name for a certificate representing a server has a name which matches a wildcard pattern for the domain name of that server, such as `*.snakeoil.com`.

The binary format of a certificate is defined using the ASN.1 notation [X208] [PKCS]. This notation defines how to specify the contents, and encoding rules define how this information is translated into binary form. The binary encoding of the certificate is defined using Distinguished Encoding Rules (DER), which are based on the more general Basic Encoding Rules (BER). For those transmissions which cannot handle binary, the binary form may be translated into an ASCII form by using Base64 encoding [MIME]. This encoded version is called PEM encoded (the name comes from "Privacy Enhanced Mail"), when placed between begin and end delimiter lines as illustrated in the following example.

Example of a PEM-encoded certificate (snakeoil.crt)

```

-----BEGIN CERTIFICATE-----
MIIC7jCCAlegAwIBAgIBATANBgkqhkiG9w0BAQQFADCBqTELMAkGA1UEBhMCWFkx
FTATBgNVBAGTDFNuYWtlIERlcnVydDETMDEGGA1UEBxMKU25ha2UgVG93bjEXMBUG
A1UEChMOU25ha2UgT21sLCBmdGQxHjAcBgNVBAsTFUNlcnRpZmljYXR1IEF1dGhv
cm10eTEVMBMGGA1UEAxMMU25ha2UgT21sIENBMR4wHAYJKoZIhvcNAQkBFg9jYUBz
bmFrZW9pbC5kb20wHhcNOTgxMDIxMDg1ODM2WhcNOTkxMDIxMDg1ODM2WjCBpzEL
MAkGA1UEBhMCWFkxFTATBgNVBAGTDFNuYWtlIERlcnVydDETMDEGGA1UEBxMKU25h
a2UgVG93bjEXMBUGA1UEChMOU25ha2UgT21sLCBmdGQxHjAcBgNVBAsTD1dlYnNl
cnZlcjBUZWFtMRkwFwYDQDExB3d3cuc25ha2VvaWwuZG9tMR8wHQYJKoZIhvcN
AQkBFhB3d3dAc25ha2VvaWwuZG9tMIGfMA0GCSqGSIb3DQEBAQUAA4GNADCBiQKB
gQDH9Ge/s2zcH+da+rPTx/DPRp3xGjHZ4GG6pCmvADIEtBtKBFACz64n+Dy7Np8b
vKR+yy5DGQiijsH1D/j8H1GE+q4TZ8OFk7BNBFazHxYbYI4OKMiCxdKzdi1yfaa
lWoANFlAz1sdbxeGVHoTOK+gT5w3UxwZKv2DLbCTzLZyPwIDAQABoYwJDAPBgNV
HRMECDAGAQH/AgEAMBEGCWCsSAGG+EIBAQQEAWIAQDANBgkqhkiG9w0BAQQFAA0B
gQAZUIHAL4D09oE6Lv2k56Gp38OBDuILvwLg1v1KL8mQR+KFjghCrtpqaztZqcDt
2q2QoyulCgSzHbEGmi0EsdKpfg6mp0penssIFePYNI+/8u9HT4LuKMXJ15hxBam7
dUHzICxBVC1lnHyYGjDuAMhe3961YAn8bC1d1/L4NMGBCQ==
-----END CERTIFICATE-----

```

Certificate Authorities

By first verifying the information in a certificate request before granting the certificate, the Certificate Authority assures the identity of the private key owner of a key-pair. For instance, if Alice requests a personal certificate, the Certificate Authority must first make sure that Alice really is the person the certificate request claims.

Certificate Chains

A Certificate Authority may also issue a certificate for another Certificate Authority. When examining a certificate, Alice may need to examine the certificate of the issuer, for each parent Certificate Authority, until reaching one which she has confidence in. She may decide to trust only certificates with a limited chain of issuers, to reduce her risk of a "bad" certificate in the chain.

Creating a Root-Level CA

As noted earlier, each certificate requires an issuer to assert the validity of the identity of the certificate subject, up to the top-level Certificate Authority (CA). This presents a problem: Since this is who vouches for the certificate of the top-level authority, which has no issuer? In this unique case, the certificate is "self-signed", so the issuer of the certificate is the same as the subject. As a result, one must exercise extra care in trusting a self-signed certificate. The wide publication of a public key by the root authority reduces the risk in trusting this key – it would be obvious if someone else publicized a key claiming to be the authority. Browsers are preconfigured to trust well-known certificate authorities.

A number of companies, such as Thawte⁷ and VeriSign⁸ have established themselves as Certificate Authorities. These companies provide the following services:

- Verifying certificate requests
- Processing certificate requests
- Issuing and managing certificates

⁷<http://www.thawte.com/>

⁸<http://www.verisign.com/>

It is also possible to create your own Certificate Authority. Although risky in the Internet environment, it may be useful within an Intranet where the organization can easily verify the identities of individuals and servers.

Certificate Management

Establishing a Certificate Authority is a responsibility which requires a solid administrative, technical, and management framework. Certificate Authorities not only issue certificates, they also manage them – that is, they determine how long certificates are valid, they renew them, and they keep lists of certificates that have already been issued but are no longer valid (Certificate Revocation Lists, or CRLs). Say Alice is entitled to a certificate as an employee of a company. Say too, that the certificate needs to be revoked when Alice leaves the company. Since certificates are objects that get passed around, it is impossible to tell from the certificate alone that it has been revoked. When examining certificates for validity, therefore, it is necessary to contact the issuing Certificate Authority to check CRLs – this is not usually an automated part of the process.

⇒ Note

If you use a Certificate Authority that is not configured into browsers by default, it is necessary to load the Certificate Authority certificate into the browser, enabling the browser to validate server certificates signed by that Certificate Authority. Doing so may be dangerous, since once loaded, the browser will accept all certificates signed by that Certificate Authority.

Secure Sockets Layer (SSL)

The Secure Sockets Layer protocol is a protocol layer which may be placed between a reliable connection-oriented network layer protocol (e.g. TCP/IP) and the application protocol layer (e.g. HTTP). SSL provides for secure communication between client and server by allowing mutual authentication, the use of digital signatures for integrity, and encryption for privacy.

The protocol is designed to support a range of choices for specific algorithms used for cryptography, digests, and signatures. This allows algorithm selection for specific servers to be made based on legal, export or other concerns, and also enables the protocol to take advantage of new algorithms. Choices are negotiated between client and server at the start of establishing a protocol session.

Table 4: Versions of the SSL protocol

Version	Source	Description	Browser Support
SSL v2.0	Vendor Standard (from Netscape Corp.) [SSL2]	First SSL protocol for which implementations exists	- NS Navigator 1.x/2.x - MS IE 3.x - Lynx/2.8+OpenSSL
SSL v3.0	Expired Internet Draft (from Netscape Corp.) [SSL3]	Revisions to prevent specific security attacks, add non-RSA ciphers, and support for certificate chains	- NS Navigator 2.x/3.x/4.x - MS IE 3.x/4.x - Lynx/2.8+OpenSSL
TLS v1.0	Proposed Internet Standard (from IETF) [TLS1]	Revision of SSL 3.0 to update the MAC layer to HMAC, add block padding for block ciphers, message order standardization and more alert messages.	- Lynx/2.8+OpenSSL

There are a number of versions of the SSL protocol, as shown in Table 4. As noted there, one of the benefits in SSL 3.0 is that it adds support of certificate chain loading. This feature allows a server to pass a server certificate along with issuer certificates to the browser. Chain loading also permits the browser to validate the server certificate, even if Certificate Authority certificates are not installed for the intermediate issuers, since they are included in the certificate chain. SSL 3.0 is the basis for the Transport Layer Security [TLS] protocol standard, currently in development by the Internet Engineering Task Force (IETF).

Session Establishment

The SSL session is established by following a handshake sequence between client and server, as shown in Figure 1. This sequence may vary, depending on whether the server is configured to provide a server certificate or request a client certificate. Though cases exist where additional handshake steps are required for management of cipher information, this article summarizes one common scenario: see the SSL specification for the full range of possibilities.

⇒ Note

Once an SSL session has been established it may be reused, thus avoiding the performance penalty of repeating the many steps needed to start a session. For this the server assigns each SSL session a unique session identifier which is cached in the server and which the client can use on forthcoming connections to reduce the handshake (until the session identifier expires in the cache of the server).

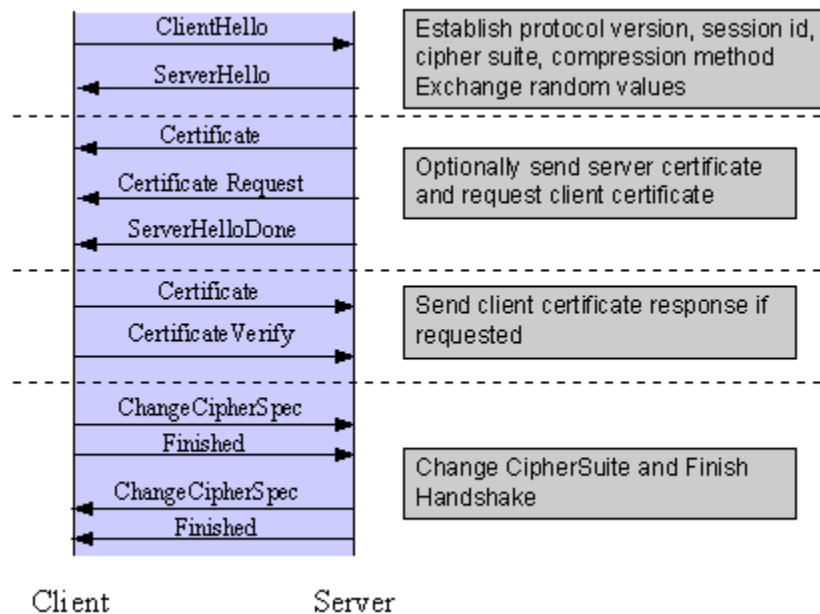

Figure 1: Simplified SSL Handshake Sequence

The elements of the handshake sequence, as used by the client and server, are listed below:

1. Negotiate the Cipher Suite to be used during data transfer
2. Establish and share a session key between client and server
3. Optionally authenticate the server to the client
4. Optionally authenticate the client to the server

The first step, Cipher Suite Negotiation, allows the client and server to choose a Cipher Suite supportable by both of them. The SSL3.0 protocol specification defines 31 Cipher Suites. A Cipher Suite is defined by the following components:

- Key Exchange Method
- Cipher for Data Transfer
- Message Digest for creating the Message Authentication Code (MAC)

These three elements are described in the sections that follow.

Key Exchange Method

The key exchange method defines how the shared secret symmetric cryptography key used for application data transfer will be agreed upon by client and server. SSL 2.0 uses RSA key exchange only, while SSL 3.0 supports a choice of key exchange algorithms including the RSA key exchange when certificates are used, and Diffie-Hellman key exchange for exchanging keys without certificates and without prior communication between client and server.

One variable in the choice of key exchange methods is digital signatures – whether or not to use them, and if so, what kind of signatures to use. Signing with a private key provides assurance against a man-in-the-middle-attack during the information exchange used in generating the shared key [AC96, p516].

Cipher for Data Transfer

SSL uses the conventional cryptography algorithm (symmetric cryptography) described earlier for encrypting messages in a session. There are nine choices, including the choice to perform no encryption:

- No encryption
- Stream Ciphers
 - RC4 with 40-bit keys
 - RC4 with 128-bit keys
- CBC Block Ciphers
 - RC2 with 40 bit key
 - DES with 40 bit key
 - DES with 56 bit key
 - Triple-DES with 168 bit key
 - Idea (128 bit key)
 - Fortezza (96 bit key)

Here "CBC" refers to Cipher Block Chaining, which means that a portion of the previously encrypted cipher text is used in the encryption of the current block. "DES" refers to the Data Encryption Standard [AC96, ch12], which has a number of variants (including DES40 and 3DES_EDE). "Idea" is one of the best and cryptographically strongest available algorithms, and "RC2" is a proprietary algorithm from RSA DSI [AC96, ch13].

Digest Function

The choice of digest function determines how a digest is created from a record unit. SSL supports the following:

- No digest (Null choice)
- MD5, a 128-bit hash
- Secure Hash Algorithm (SHA-1), a 160-bit hash

The message digest is used to create a Message Authentication Code (MAC) which is encrypted with the message to provide integrity and to prevent against replay attacks.

Handshake Sequence Protocol

The handshake sequence uses three protocols:

- The SSL Handshake Protocol for performing the client and server SSL session establishment.
- The SSL Change Cipher Spec Protocol for actually establishing agreement on the Cipher Suite for the session.
- The SSL Alert Protocol for conveying SSL error messages between client and server.

These protocols, as well as application protocol data, are encapsulated in the SSL Record Protocol, as shown in Figure 2. An encapsulated protocol is transferred as data by the lower layer protocol, which does not examine the data. The encapsulated protocol has no knowledge of the underlying protocol.

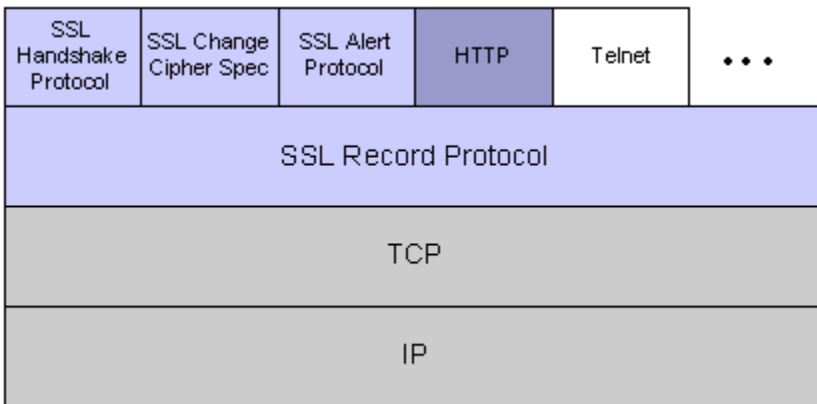

Figure 2: SSL Protocol Stack

The encapsulation of SSL control protocols by the record protocol means that if an active session is renegotiated the control protocols will be transmitted securely. If there were no session before, then the Null cipher suite is used, which means there is no encryption and messages have no integrity digests until the session has been established.

Data Transfer

The SSL Record Protocol, shown in Figure 3, is used to transfer application and SSL Control data between the client and server, possibly fragmenting this data into smaller units, or combining multiple higher level protocol data messages into single units. It may compress, attach digest signatures, and encrypt these units before transmitting them using the underlying reliable transport protocol (Note: currently all major SSL implementations lack support for compression).

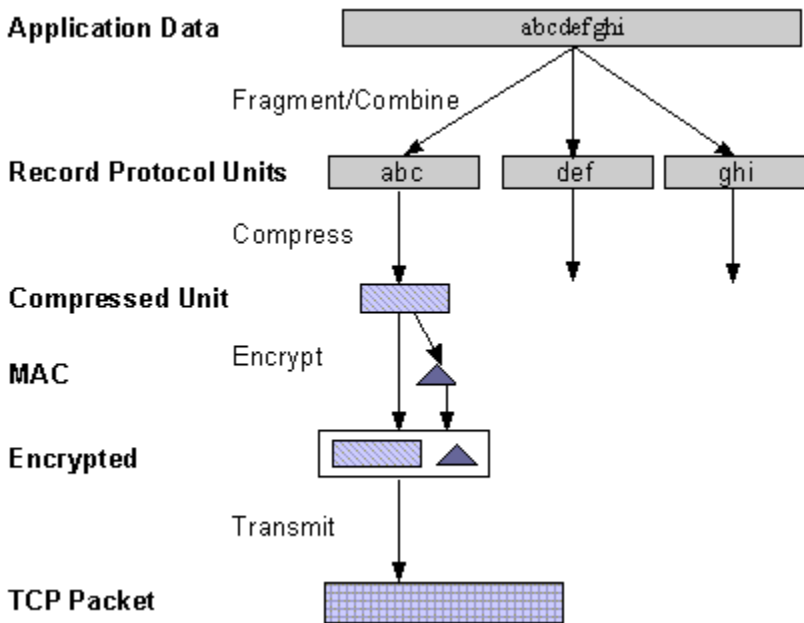

Figure 3: SSL Record Protocol

Securing HTTP Communication

One common use of SSL is to secure Web HTTP communication between a browser and a webserver. This case does not preclude the use of non-secured HTTP. The secure version is mainly plain HTTP over SSL (named HTTPS), but with one major difference: it uses the URL scheme `https` rather than `http` and a different server port (by default 443). This mainly is what `MOD_SSL` provides to you for the Apache webserver...

References

- [AC96] Bruce Schneier, Applied Cryptography, 2nd Edition, Wiley, 1996. See <http://www.counterpane.com/> for various other materials by Bruce Schneier.
- [X208] ITU-T Recommendation X.208, Specification of Abstract Syntax Notation One (ASN.1), 1988. See for instance <http://www.itu.int/rec/recommendation.asp?type=items&lang=e&parent=T-REC-X.208-198811-I>.
- [X509] ITU-T Recommendation X.509, The Directory - Authentication Framework. See for instance <http://www.itu.int/rec/recommendation.asp?type=folders&lang=e&parent=T-REC-X.509>.
- [PKCS] Public Key Cryptography Standards (PKCS), RSA Laboratories Technical Notes, See <http://www.rsasecurity.com/rsalabs/pkcs/>.
- [MIME] N. Freed, N. Borenstein, Multipurpose Internet Mail Extensions (MIME) Part One: Format of Internet Message Bodies, RFC2045. See for instance <http://ietf.org/rfc/rfc2045.txt>.
- [SSL2] Kipp E.B. Hickman, The SSL Protocol, 1995. See http://www.netscape.com/eng/security/SSL_2.html.
- [SSL3] Alan O. Freier, Philip Karlton, Paul C. Kocher, The SSL Protocol Version 3.0, 1996. See <http://www.netscape.com/eng/ssl3/draft302.txt>.
- [TLS1] Tim Dierks, Christopher Allen, The TLS Protocol Version 1.0, 1999. See <http://ietf.org/rfc/rfc2246.txt>.

5.3 SSL/TLS Strong Encryption: Compatibility

All PCs are compatible. But some of them are more compatible than others.
– Unknown

Here we talk about backward compatibility to other SSL solutions. As you perhaps know, `mod_ssl` is not the only existing SSL solution for Apache. Actually there are four additional major products available on the market: Ben Laurie's freely available Apache-SSL⁹ (from where `mod_ssl` were originally derived in 1998), Red Hat's commercial Secure Web Server¹⁰ (which is based on `mod_ssl`), Covalent's commercial Raven SSL Module¹¹ (also based on `mod_ssl`) and finally C2Net's commercial product Stronghold¹² (based on a different evolution branch named Sioux up to Stronghold 2.x and based on `mod_ssl` since Stronghold 3.x).

The idea in `mod_ssl` is mainly the following: because `mod_ssl` provides mostly a superset of the functionality of all other solutions we can easily provide backward compatibility for most of the cases. Actually there are three compatibility areas we currently address: configuration directives, environment variables and custom log functions.

Configuration Directives

For backward compatibility to the configuration directives of other SSL solutions we do an on-the-fly mapping: directives which have a direct counterpart in `mod_ssl` are mapped silently while other directives lead to a warning message in the logfiles. The currently implemented directive mapping is listed in Table 1. Currently full backward compatibility is provided only for Apache-SSL 1.x and `mod_ssl` 2.0.x. Compatibility to Sioux 1.x and Stronghold 2.x is only partial because of special functionality in these interfaces which `mod_ssl` (still) doesn't provide.

Table 1: Configuration Directive Mapping

Old Directive	<code>mod_ssl</code> Directive	Comment
Apache-SSL 1.x & <code>mod_ssl</code> 2.0.x compatibility:		
<code>SSLEnable</code>	<code>SSLEngine on</code>	compactified
<code>SSLDisable</code>	<code>SSLEngine off</code>	compactified
<code>SSLLogFile file</code>	<code>SSLLog file</code>	compactified
<code>SSLRequiredCiphers spec</code>	<code>SSLCipherSuite spec</code>	renamed
<code>SSLRequireCipher c1 ...</code>	<code>SSLRequire %{SSL_CIPHER} in {"c1", ...}</code>	generalized
<code>SSLBanCipher c1 ...</code>	<code>SSLRequire not (%{SSL_CIPHER} in {"c1", ...})</code>	generalized
<code>SSLFakeBasicAuth</code>	<code>SSLOptions +FakeBasicAuth</code>	merged
<code>SSLCacheServerPath dir</code>	-	functionality removed
<code>SSLCacheServerPort integer</code>	-	functionality removed
Apache-SSL 1.x compatibility:		
<code>SSLExportClientCertificates</code>	<code>SSLOptions +ExportCertData</code>	merged
<code>SSLCacheServerRunDir dir</code>	-	functionality not supported
Sioux 1.x compatibility:		
<code>SSL_CertFile file</code>	<code>SSLCertificateFile file</code>	renamed
<code>SSL_KeyFile file</code>	<code>SSLCertificateKeyFile file</code>	renamed
<code>SSL_CipherSuite arg</code>	<code>SSLCipherSuite arg</code>	renamed

⁹<http://www.apache-ssl.org/>

¹⁰<http://www.redhat.com/products/product-details.phtml?id=rhsa>

¹¹<http://raven.covalent.net/>

¹²<http://www.c2.net/products/stronghold/>

SSL_X509VerifyDir <i>arg</i>	SSLCACertificatePath <i>arg</i>	renamed
SSL_Log <i>file</i>	SSLLogFile <i>file</i>	renamed
SSL_Connect <i>flag</i>	SSLEngine <i>flag</i>	renamed
SSL_ClientAuth <i>arg</i>	SSLVerifyClient <i>arg</i>	renamed
SSL_X509VerifyDepth <i>arg</i>	SSLVerifyDepth <i>arg</i>	renamed
SSL_FetchKeyPhraseFrom <i>arg</i>	-	not directly mappable; use SSLPassPhraseDialog
SSL_SessionDir <i>dir</i>	-	not directly mappable; use SSLSession- Cache
SSL_Require <i>expr</i>	-	not directly mappable; use SSLRequire
SSL_CertFileType <i>arg</i>	-	functionality not supported
SSL_KeyFileType <i>arg</i>	-	functionality not supported
SSL_X509VerifyPolicy <i>arg</i>	-	functionality not supported
SSL_LogX509Attributes <i>arg</i>	-	functionality not supported
Stronghold 2.x compatibility:		
StrongholdAccelerator <i>dir</i>	-	functionality not supported
StrongholdKey <i>dir</i>	-	functionality not supported
StrongholdLicenseFile <i>dir</i>	-	functionality not supported
SSLFlag <i>flag</i>	SSLEngine <i>flag</i>	renamed
SSLSessionLockFile <i>file</i>	SSLMutex <i>file</i>	renamed
SSLCipherList <i>spec</i>	SSLCipherSuite <i>spec</i>	renamed
RequireSSL	SSLRequireSSL	renamed
SSL_ErrorFile <i>file</i>	-	functionality not supported
SSLRoot <i>dir</i>	-	functionality not supported
SSL_CertificateLogDir <i>dir</i>	-	functionality not supported
AuthCertDir <i>dir</i>	-	functionality not supported
SSL_Group <i>name</i>	-	functionality not supported
SSLProxyMachineCertPath <i>dir</i>	-	functionality not supported
SSLProxyMachineCertFile <i>file</i>	-	functionality not supported
SSLProxyCACertificatePath <i>dir</i>	-	functionality not supported
SSLProxyCACertificateFile <i>file</i>	-	functionality not supported
SSLProxyVerifyDepth <i>number</i>	-	functionality not supported
SSLProxyCipherList <i>spec</i>	-	functionality not supported

Environment Variables

When you use “SSLOptions +CompatEnvVars” additional environment variables are generated. They all correspond to existing official mod_ssl variables. The currently implemented variable derivation is listed in Table 2.

Table 2: Environment Variable Derivation

Old Variable	mod_ssl Variable	Comment
SSL_PROTOCOL_VERSION	SSL_PROTOCOL	renamed
SSLEAY_VERSION	SSL_VERSION_LIBRARY	renamed
HTTPS_SECRETKEYSIZE	SSL_CIPHER_USEKEYSIZE	renamed
HTTPS_KEYSIZE	SSL_CIPHER_ALGKEYSIZE	renamed
HTTPS_CIPHER	SSL_CIPHER	renamed
HTTPS_EXPORT	SSL_CIPHER_EXPORT	renamed
SSL_SERVER_KEY_SIZE	SSL_CIPHER_ALGKEYSIZE	renamed
SSL_SERVER_CERTIFICATE	SSL_SERVER_CERT	renamed
SSL_SERVER_CERT_START	SSL_SERVER_V_START	renamed
SSL_SERVER_CERT_END	SSL_SERVER_V_END	renamed

SSL_SERVER_CERT_SERIAL	SSL_SERVER_M.SERIAL	renamed
SSL_SERVER_SIGNATURE_ALGORITHM	SSL_SERVER_A.SIG	renamed
SSL_SERVER_DN	SSL_SERVER_S.DN	renamed
SSL_SERVER_CN	SSL_SERVER_S.DN_CN	renamed
SSL_SERVER_EMAIL	SSL_SERVER_S.DN.Email	renamed
SSL_SERVER_O	SSL_SERVER_S.DN_O	renamed
SSL_SERVER_OU	SSL_SERVER_S.DN_OU	renamed
SSL_SERVER_C	SSL_SERVER_S.DN_C	renamed
SSL_SERVER_SP	SSL_SERVER_S.DN.SP	renamed
SSL_SERVER_L	SSL_SERVER_S.DN.L	renamed
SSL_SERVER_IDN	SSL_SERVER_I.DN	renamed
SSL_SERVER_ICN	SSL_SERVER_I.DN_CN	renamed
SSL_SERVER_IEMAIL	SSL_SERVER_I.DN.Email	renamed
SSL_SERVER_IO	SSL_SERVER_I.DN_O	renamed
SSL_SERVER_IOU	SSL_SERVER_I.DN_OU	renamed
SSL_SERVER_IC	SSL_SERVER_I.DN_C	renamed
SSL_SERVER_ISP	SSL_SERVER_I.DN.SP	renamed
SSL_SERVER_IL	SSL_SERVER_I.DN.L	renamed
SSL_CLIENT_CERTIFICATE	SSL_CLIENT_CERT	renamed
SSL_CLIENT_CERT_START	SSL_CLIENT_V.START	renamed
SSL_CLIENT_CERT_END	SSL_CLIENT_V.END	renamed
SSL_CLIENT_CERT_SERIAL	SSL_CLIENT_M.SERIAL	renamed
SSL_CLIENT_SIGNATURE_ALGORITHM	SSL_CLIENT_A.SIG	renamed
SSL_CLIENT_DN	SSL_CLIENT_S.DN	renamed
SSL_CLIENT_CN	SSL_CLIENT_S.DN_CN	renamed
SSL_CLIENT_EMAIL	SSL_CLIENT_S.DN.Email	renamed
SSL_CLIENT_O	SSL_CLIENT_S.DN_O	renamed
SSL_CLIENT_OU	SSL_CLIENT_S.DN_OU	renamed
SSL_CLIENT_C	SSL_CLIENT_S.DN_C	renamed
SSL_CLIENT_SP	SSL_CLIENT_S.DN.SP	renamed
SSL_CLIENT_L	SSL_CLIENT_S.DN.L	renamed
SSL_CLIENT_IDN	SSL_CLIENT_I.DN	renamed
SSL_CLIENT_ICN	SSL_CLIENT_I.DN_CN	renamed
SSL_CLIENT_IEMAIL	SSL_CLIENT_I.DN.Email	renamed
SSL_CLIENT_IO	SSL_CLIENT_I.DN_O	renamed
SSL_CLIENT_IOU	SSL_CLIENT_I.DN_OU	renamed
SSL_CLIENT_IC	SSL_CLIENT_I.DN_C	renamed
SSL_CLIENT_ISP	SSL_CLIENT_I.DN.SP	renamed
SSL_CLIENT_IL	SSL_CLIENT_I.DN.L	renamed
SSL_EXPORT	SSL_CIPHER_EXPORT	renamed
SSL_KEYSIZE	SSL_CIPHER_ALGKEYSIZE	renamed
SSL_SECKEYSIZE	SSL_CIPHER_USEKEYSIZE	renamed
SSL_SSLEAY_VERSION	SSL_VERSION_LIBRARY	renamed
SSL_STRONG_CRYPTO	-	Not supported by mod_ssl
SSL_SERVER_KEY_EXP	-	Not supported by mod_ssl
SSL_SERVER_KEY_ALGORITHM	-	Not supported by mod_ssl
SSL_SERVER_KEY_SIZE	-	Not supported by mod_ssl
SSL_SERVER_SESSIONDIR	-	Not supported by mod_ssl
SSL_SERVER_CERTIFICATELOGDIR	-	Not supported by mod_ssl
SSL_SERVER_CERTFILE	-	Not supported by mod_ssl
SSL_SERVER_KEYFILE	-	Not supported by mod_ssl
SSL_SERVER_KEYFILETYPE	-	Not supported by mod_ssl
SSL_CLIENT_KEY_EXP	-	Not supported by mod_ssl

SSL_CLIENT_KEY_ALGORITHM	-	Not supported by mod_ssl
SSL_CLIENT_KEY_SIZE	-	Not supported by mod_ssl

Custom Log Functions

When mod_ssl is built into Apache or at least loaded (under DSO situation) additional functions exist for the Custom Log Format (p. 471) of `MOD_LOG_CONFIG` as documented in the Reference Chapter. Beside the “`%{varname}x`” eXtension format function which can be used to expand any variables provided by any module, an additional Cryptography “`%{name}c`” cryptography format function exists for backward compatibility. The currently implemented function calls are listed in Table 3.

Table 3: Custom Log Cryptography Function

Function Call	Description
<code>%...{version}c</code>	SSL protocol version
<code>%...{cipher}c</code>	SSL cipher
<code>%...{subjectdn}c</code>	Client Certificate Subject Distinguished Name
<code>%...{issuerdn}c</code>	Client Certificate Issuer Distinguished Name
<code>%...{errcode}c</code>	Certificate Verification Error (numerical)
<code>%...{errstr}c</code>	Certificate Verification Error (string)

5.4 SSL/TLS Strong Encryption: How-To

The solution of this problem is trivial and is left as an exercise for the reader.
– Standard textbook cookie

How to solve particular security constraints for an SSL-aware webserver is not always obvious because of the coherences between SSL, HTTP and Apache's way of processing requests. This chapter gives instructions on how to solve such typical situations. Treat it as a first step to find out the final solution, but always try to understand the stuff before you use it. Nothing is worse than using a security solution without knowing its restrictions and coherences.

Cipher Suites and Enforced Strong Security

- SSLv2 only server
- strong encryption only server
- server gated cryptography
- stronger per-directory requirements

How can I create a real SSLv2-only server?

The following creates an SSL server which speaks only the SSLv2 protocol and its ciphers.

```
httpd.conf
SSLProtocol -all +SSLv2
SSLCipherSuite SSLv2:+HIGH:+MEDIUM:+LOW:+EXP
```

How can I create an SSL server which accepts strong encryption only?

The following enables only the seven strongest ciphers:

```
httpd.conf
SSLProtocol all
SSLCipherSuite HIGH:MEDIUM
```

How can I create an SSL server which accepts strong encryption only, but allows export browsers to upgrade to stronger encryption?

This facility is called Server Gated Cryptography (SGC) and details you can find in the `README.GlobalID` document in the `mod_ssl` distribution. In short: The server has a Global ID server certificate, signed by a special CA certificate from Verisign which enables strong encryption in export browsers. This works as following: The browser connects with an export cipher, the server sends its Global ID certificate, the browser verifies it and subsequently upgrades the cipher suite before any HTTP communication takes place. The question now is: How can we allow this upgrade, but enforce strong encryption. Or in other words: Browser either have to initially connect with strong encryption or have to upgrade to strong encryption, but are not allowed to keep the export ciphers. The following does the trick:

```

httpd.conf
# allow all ciphers for the initial handshake,
# so export browsers can upgrade via SGC facility
SSLCipherSuite ALL:!ADH:RC4+RSA:+HIGH:+MEDIUM:+LOW:+SSLv2:+EXP:+eNULL
<Directory /usr/local/apache2/htdocs>
# but finally deny all browsers which haven't upgraded
SSLRequire %{SSL_CIPHER_USEKEYSIZE} >= 128
</Directory>

```

How can I create an SSL server which accepts all types of ciphers in general, but requires a strong ciphers for access to a particular URL?

Obviously you cannot just use a server-wide `SSLCIPHERSUITE` which restricts the ciphers to the strong variants. But `mod_ssl` allows you to reconfigure the cipher suite in per-directory context and automatically forces a renegotiation of the SSL parameters to meet the new configuration. So, the solution is:

```

# be liberal in general
SSLCipherSuite ALL:!ADH:RC4+RSA:+HIGH:+MEDIUM:+LOW:+SSLv2:+EXP:+eNULL
<Location /strong/area>
# but https://hostname/strong/area/ and below
# requires strong ciphers
SSLCipherSuite HIGH:MEDIUM
</Location>

```

Client Authentication and Access Control

- simple certificate-based client authentication
- selective certificate-based client authentication
- particular certificate-based client authentication
- intranet vs. internet authentication

How can I authenticate clients based on certificates when I know all my clients?

When you know your user community (i.e. a closed user group situation), as it's the case for instance in an Intranet, you can use plain certificate authentication. All you have to do is to create client certificates signed by your own CA certificate `ca.crt` and then verify the clients against this certificate.

```

httpd.conf
# require a client certificate which has to be directly
# signed by our CA certificate in ca.crt
SSLVerifyClient require
SSLVerifyDepth 1
SSLCACertificateFile conf/ssl.crt/ca.crt

```

How can I authenticate my clients for a particular URL based on certificates but still allow arbitrary clients to access the remaining parts of the server?

For this we again use the per-directory reconfiguration feature of [MOD_SSL](#):

```
httpd.conf
SSLVerifyClient none
SSLCACertificateFile conf/ssl.crt/ca.crt
<Location /secure/area>
SSLVerifyClient require
SSLVerifyDepth 1
</Location>
```

How can I authenticate only particular clients for a some URLs based on certificates but still allow arbitrary clients to access the remaining parts of the server?

The key is to check for various ingredients of the client certificate. Usually this means to check the whole or part of the Distinguished Name (DN) of the Subject. For this two methods exists: The [MOD_AUTH](#) based variant and the [SSLREQUIRE](#) variant. The first method is good when the clients are of totally different type, i.e. when their DNs have no common fields (usually the organisation, etc.). In this case you've to establish a password database containing *all* clients. The second method is better when your clients are all part of a common hierarchy which is encoded into the DN. Then you can match them more easily.

The first method:

httpd.conf

```
SSLVerifyClient    none
<Directory /usr/local/apache2/htdocs/secure/area>

SSLVerifyClient    require
SSLVerifyDepth     5
SSLCACertificateFile conf/ssl.crt/ca.crt
SSLCACertificatePath conf/ssl.crt
SSLOptions         +FakeBasicAuth
SSLRequireSSL
AuthName           "Snake Oil Authentication"
AuthType           Basic
AuthUserFile       /usr/local/apache2/conf/httpd.passwd
require            valid-user
</Directory>
```

httpd.passwd

```
/C=DE/L=Munich/O=Snake Oil, Ltd./OU=Staff/CN=Foo:xxj31ZMTZzkVA
/C=US/L=S.F./O=Snake Oil, Ltd./OU=CA/CN=Bar:xxj31ZMTZzkVA
/C=US/L=L.A./O=Snake Oil, Ltd./OU=Dev/CN=Quux:xxj31ZMTZzkVA
```

The second method:

httpd.conf

```
SSLVerifyClient      none
<Directory /usr/local/apache2/htdocs/secure/area>

    SSLVerifyClient      require
    SSLVerifyDepth      5
    SSLCACertificateFile conf/ssl.crt/ca.crt
    SSLCACertificatePath conf/ssl.crt
    SSLOptions           +FakeBasicAuth
    SSLRequireSSL
    SSLRequire          %{SSL_CLIENT_S_DN_O} eq "Snake Oil, Ltd." \
and %{SSL_CLIENT_S_DN_OU} in {"Staff", "CA", "Dev"}
</Directory>
```

How can I require HTTPS with strong ciphers and either basic authentication or client certificates for access to a subarea on the Intranet website for clients coming from the Internet but still allow plain HTTP access for clients on the Intranet?

Let us assume the Intranet can be distinguished through the IP network 192.160.1.0/24 and the subarea on the Intranet website has the URL /subarea. Then configure the following outside your HTTPS virtual host (so it applies to both HTTPS and HTTP):

httpd.conf

```
SSLCACertificateFile conf/ssl.crt/company-ca.crt

<Directory /usr/local/apache2/htdocs>
#   Outside the subarea only Intranet access is granted
Order                deny,allow
Deny                 from all
Allow                from 192.168.1.0/24
</Directory>

<Directory /usr/local/apache2/htdocs/subarea>
#   Inside the subarea any Intranet access is allowed
#   but from the Internet only HTTPS + Strong-Cipher + Password
#   or the alternative HTTPS + Strong-Cipher + Client-Certificate

#   If HTTPS is used, make sure a strong cipher is used.
#   Additionally allow client certs as alternative to basic auth.
SSLVerifyClient      optional
SSLVerifyDepth       1
SSLOptions            +FakeBasicAuth +StrictRequire
SSLRequire            %{SSL_CIPHER_USEKEYSIZE} >= 128

#   Force clients from the Internet to use HTTPS
RewriteEngine        on
RewriteCond           %{REMOTE_ADDR} !^192\.168\.1\.[0-9]+$
RewriteCond           %{HTTPS} !=on
RewriteRule           .* - [F]

#   Allow Network Access and/or Basic Auth
Satisfy               any

#   Network Access Control
Order                deny,allow
Deny                 from all
Allow                192.168.1.0/24

#   HTTP Basic Authentication
AuthType              basic
AuthName              "Protected Intranet Area"
AuthUserFile          conf/protected.passwd
Require               valid-user
</Directory>
```

5.5 SSL/TLS Strong Encryption: FAQ

The wise man doesn't give the right answers, he poses the right questions.
– Claude Levi-Strauss

This chapter is a collection of frequently asked questions (FAQ) and corresponding answers following the popular USENET tradition. Most of these questions occurred on the News-group comp.infosystems.www.servers.unix¹³ or the mod_ssl Support Mailing List modssl-users@modssl.org¹⁴. They are collected at this place to avoid answering the same questions over and over.

Please read this chapter at least once when installing mod_ssl or at least search for your problem here before submitting a problem report to the author.

About The Module

- What is the history of mod_ssl?
- mod_ssl and Year 2000?
- mod_ssl and Wassenaar Arrangement?

What is the history of mod_ssl?

The mod_ssl v1 package was initially created in April 1998 by Ralf S. Engelschall¹⁵ via porting Ben Laurie¹⁶'s Apache-SSL¹⁷ 1.17 source patches for Apache 1.2.6 to Apache 1.3b6. Because of conflicts with Ben Laurie's development cycle it then was re-assembled from scratch for Apache 1.3.0 by merging the old mod_ssl 1.x with the newer Apache-SSL 1.18. From this point on mod_ssl lived its own life as mod_ssl v2. The first publicly released version was mod_ssl 2.0.0 from August 10th, 1998.

After US export restrictions on cryptographic software were loosened, [MOD_SSL](#) became part of the Apache HTTP Server with the release of Apache httpd 2.

Is mod_ssl affected by the Wassenaar Arrangement?

First, let us explain what Wassenaar and its Arrangement on Export Controls for Conventional Arms and Dual-Use Goods and Technologies is: This is a international regime, established in 1995, to control trade in conventional arms and dual-use goods and technology. It replaced the previous CoCom regime. Further details on both the Arrangement and its signatories are available at <http://www.wassenaar.org/>.

In short, the aim of the Wassenaar Arrangement is to prevent the build up of military capabilities that threaten regional and international security and stability. The Wassenaar Arrangement controls the export of cryptography as a dual-use good, that is, something that has both military and civilian applications. However, the Wassenaar Arrangement also provides an exemption from export controls for mass-market software and free software.

In the current Wassenaar List of Dual Use Goods and Technologies And Munitions, under GENERAL SOFTWARE NOTE (GSN) it says The Lists do not control "software" which is either: 1. [...] 2. "in the public domain". And under DEFINITIONS OF TERMS USED IN THESE LISTS we find In the public domain defined as "technology" or "software" which has been made available without restrictions upon its further dissemination. Note: Copyright restrictions do not remove "technology" or "software" from being "in the public domain".

¹³[news:comp.infosystems.www.servers.unix](mailto:comp.infosystems.www.servers.unix)

¹⁴<mailto:modssl-users@modssl.org>

¹⁵<mailto:rse@engelschall.com>

¹⁶<mailto:ben@algroup.co.uk>

¹⁷<http://www.apache-ssl.org/>

So, both `mod_ssl` and OpenSSL are in the public domain for the purposes of the Wassenaar Arrangement and its List of Dual Use Goods and Technologies And Munitions List, and thus not affected by its provisions.

Installation

- Why do I get permission errors related to SSLMutex when I start Apache?
- Why does `mod_ssl` stop with the error "Failed to generate temporary 512 bit RSA private key", when I start Apache?

Why do I get permission errors related to SSLMutex when I start Apache?

Errors such as “`mod_ssl: Child could not open SSLMutex lockfile /opt/apache/logs/ssl_mutex.18332 (System error follows) [...] System: Permission denied (errno: 13)`” are usually caused by overly restrictive permissions on the *parent* directories. Make sure that all parent directories (here `/opt`, `/opt/apache` and `/opt/apache/logs`) have the `x`-bit set for, at minimum, the UID under which Apache’s children are running (see the [USER](#) directive).

Why does `mod_ssl` stop with the error "Failed to generate temporary 512 bit RSA private key", when I start Apache?

Cryptographic software needs a source of unpredictable data to work correctly. Many open source operating systems provide a "randomness device" that serves this purpose (usually named `/dev/random`). On other systems, applications have to seed the OpenSSL Pseudo Random Number Generator (PRNG) manually with appropriate data before generating keys or performing public key encryption. As of version 0.9.5, the OpenSSL functions that need randomness report an error if the PRNG has not been seeded with at least 128 bits of randomness.

To prevent this error, `MOD_SSL` has to provide enough entropy to the PRNG to allow it to work correctly. This can be done via the `SSLRANDOMSEED` directives.

Configuration

- Is it possible to provide HTTP and HTTPS from the same server?
- Which port does HTTPS use?
- How do I speak HTTPS manually for testing purposes?
- Why does the connection hang when I connect to my SSL-aware Apache server?
- Why do I get “Connection Refused” errors, when trying to access my newly installed Apache+`mod_ssl` server via HTTPS?
- Why are the `SSL_XXX` variables not available to my CGI & SSI scripts?
- How can I switch between HTTP and HTTPS in relative hyperlinks?

Is it possible to provide HTTP and HTTPS from the same server?

Yes. HTTP and HTTPS use different server ports (HTTP binds to port 80, HTTPS to port 443), so there is no direct conflict between them. You can either run two separate server instances bound to these ports, or use Apache’s elegant virtual hosting facility to create two virtual servers over one instance of Apache - one responding to requests on port 80 and speaking HTTP and the other responding to requests on port 443 speaking HTTPS.

Which port does HTTPS use?

You can run HTTPS on any port, but the standards specify port 443, which is where any HTTPS compliant browser will look by default. You can force your browser to look on a different port by specifying it in the URL like this (for port 666): `https://secure.server.dom:666/`

How do I speak HTTPS manually for testing purposes?

While you usually just use

```
$ telnet localhost 80
GET / HTTP/1.0
```

for simple testing of Apache via HTTP, it's not so easy for HTTPS because of the SSL protocol between TCP and HTTP. With the help of OpenSSL's `s_client` command, however, you can do a similar check for HTTPS:

```
$ openssl s_client -connect localhost:443 -state -debug
GET / HTTP/1.0
```

Before the actual HTTP response you will receive detailed information about the SSL handshake. For a more general command line client which directly understands both HTTP and HTTPS, can perform GET and POST operations, can use a proxy, supports byte ranges, etc. you should have a look at the nifty `cURL`¹⁸ tool. Using this, you can check that Apache is responding correctly on ports 80 and 443 as follows:

```
$ curl http://localhost/
$ curl https://localhost/
```

Why does the connection hang when I connect to my SSL-aware Apache server?

Because you connected with HTTP to the HTTPS port, i.e. you used an URL of the form “`http://`” instead of “`https://`”. This also happens the other way round when you connect via HTTPS to a HTTP port, i.e. when you try to use “`https://`” on a server that doesn't support SSL (on this port). Make sure you are connecting to a virtual server that supports SSL, which is probably the IP associated with your hostname, not localhost (127.0.0.1).

Why do I get “Connection Refused” messages, when trying to access my newly installed Apache+mod_ssl server via HTTPS?

This can happen for various reasons. The most common mistakes include starting Apache with just `apachectl start` (or `httpd`) instead of `apachectl startssl` (or `httpd -DSSL`). Your configuration may also be incorrect. Please make sure that your `LISTEN` directives match your `<VIRTUALHOST>` directives. If all else fails, please start afresh, using the default configuration provided by `MOD_SSL`.

Why are the `SSL_XXX` variables not available to my CGI & SSI scripts?

Please make sure you have “`SSLOptions +StdEnvVars`” enabled for the context of your CGI/SSI requests.

¹⁸<http://curl.haxx.se/>

How can I switch between HTTP and HTTPS in relative hyperlinks?

Usually, to switch between HTTP and HTTPS, you have to use fully-qualified hyperlinks (because you have to change the URL scheme). Using `MOD_REWRITE` however, you can manipulate relative hyperlinks, to achieve the same effect.

```
RewriteEngine on
RewriteRule ^/(.*)$ :SSL$ https://%{SERVER_NAME}/$1 [R,L]
RewriteRule ^/(.*)$ :NOSSL$ http://%{SERVER_NAME}/$1 [R,L]
```

This rewrite ruleset lets you use hyperlinks of the form ``, to switch to HTTPS in a relative link.

Certificates

- What are RSA Private Keys, CSRs and Certificates?
- Is there a difference on startup between the original Apache and an SSL-aware Apache?
- How do I create a self-signed SSL Certificate for testing purposes?
- How do I create a real SSL Certificate?
- How do I create and use my own Certificate Authority (CA)?
- How can I change the pass-phrase on my private key file?
- How can I get rid of the pass-phrase dialog at Apache startup time?
- How do I verify that a private key matches its Certificate?
- Why do connections fail with an "alert bad certificate" error?
- Why does my 2048-bit private key not work?
- Why is client authentication broken after upgrading from SSLeay version 0.8 to 0.9?
- How can I convert a certificate from PEM to DER format?
- Why can't I find the `getca` or `getverisign` programs mentioned by Verisign, for installing my Verisign certificate?
- Can I use the Server Gated Cryptography (SGC) facility (aka Verisign Global ID) with `mod_ssl`?
- Why do browsers complain that they cannot verify my Verisign Global ID server certificate?

What are RSA Private Keys, CSRs and Certificates?

An RSA private key file is a digital file that you can use to decrypt messages sent to you. It has a public component which you distribute (via your Certificate file) which allows people to encrypt those messages to you.

A Certificate Signing Request (CSR) is a digital file which contains your public key and your name. You send the CSR to a Certifying Authority (CA), who will convert it into a real Certificate, by signing it.

A Certificate contains your RSA public key, your name, the name of the CA, and is digitally signed by the CA. Browsers that know the CA can verify the signature on that Certificate, thereby obtaining your RSA public key. That enables them to send messages which only you can decrypt.

See the Introduction (p. 147) chapter for a general description of the SSL protocol.

Is there a difference on startup between the original Apache and an SSL-aware Apache?

Yes. In general, starting Apache with `MOD_SSL` built-in is just like starting Apache without it. However, if you have a passphrase on your SSL private key file, a startup dialog will pop up which asks you to enter the pass phrase.

Having to manually enter the passphrase when starting the server can be problematic - for example, when starting the server from the system boot scripts. In this case, you can follow the steps below to remove the passphrase from your private key.

How do I create a self-signed SSL Certificate for testing purposes?

1. Make sure OpenSSL is installed and in your `PATH`.
2. Run the following command, to create `server.key` and `server.crt` files:

```
$ openssl req -new -x509 -nodes -out server.crt -keyout server.key
```

 These can be used as follows in your `httpd.conf` file:

```
SSLCertificateFile    /path/to/this/server.crt
SSLCertificateKeyFile /path/to/this/server.key
```

3. It is important that you are aware that this `server.key` does *not* have any passphrase. To add a passphrase to the key, you should run the following command, and enter & verify the passphrase as requested.

```
$ openssl rsa -des3 -in server.key -out server.key.new
$ mv server.key.new server.key
```

 Please backup the `server.key` file, and the passphrase you entered, in a secure location.

How do I create a real SSL Certificate?

Here is a step-by-step description:

1. Make sure OpenSSL is installed and in your `PATH`.
2. Create a RSA private key for your Apache server (will be Triple-DES encrypted and PEM formatted):

```
$ openssl genrsa -des3 -out server.key 1024
```

 Please backup this `server.key` file and the pass-phrase you entered in a secure location. You can see the details of this RSA private key by using the command:

```
$ openssl rsa -noout -text -in server.key
```

 If necessary, you can also create a decrypted PEM version (not recommended) of this RSA private key with:

```
$ openssl rsa -in server.key -out server.key.unsecure
```
3. Create a Certificate Signing Request (CSR) with the server RSA private key (output will be PEM formatted):

```
$ openssl req -new -key server.key -out server.csr
```

 Make sure you enter the FQDN ("Fully Qualified Domain Name") of the server when OpenSSL prompts you for the "CommonName", i.e. when you generate a CSR for a website which will be later accessed via `https://www.foo.dom/`, enter "www.foo.dom" here. You can see the details of this CSR by using

```
$ openssl req -noout -text -in server.csr
```

4. You now have to send this Certificate Signing Request (CSR) to a Certifying Authority (CA) to be signed. Once the CSR has been signed, you will have a real Certificate, which can be used by Apache. You can have a CSR signed by a commercial CA, or you can create your own CA to sign it.

Commercial CAs usually ask you to post the CSR into a web form, pay for the signing, and then send a signed Certificate, which you can store in a `server.crt` file. For more information about commercial CAs see the following locations:

- (a) Verisign

<http://digitalid.verisign.com/server/apacheNotice.htm> ¹⁹

- (b) Thawte

<http://www.thawte.com/>

- (c) CertiSign Certificadora Digital Ltda.

<http://www.certsign.com.br> ²⁰

- (d) IKS GmbH

<http://www.iks-jena.de/leistungen/ca/> ²¹

- (e) Uptime Commerce Ltd.

<http://www.uptimecommerce.com> ²²

- (f) BelSign NV/SA

<http://www.belsign.be> ²³

For details on how to create your own CA, and use this to sign a CSR, see below.

Once your CSR has been signed, you can see the details of the Certificate as follows:

```
$ openssl x509 -noout -text -in server.crt
```

5. You should now have two files: `server.key` and `server.crt`. These can be used as follows in your `httpd.conf` file:

```
SSLCertificateFile    /path/to/this/server.crt
SSLCertificateKeyFile /path/to/this/server.key
```

The `server.csr` file is no longer needed.

¹⁹<http://digitalid.verisign.com/server/apacheNotice.htm>

²⁰<http://www.certsign.com.br>

²¹<http://www.iks-jena.de/leistungen/ca/>

²²<http://www.uptimecommerce.com>

²³<http://www.belsign.be>

How do I create and use my own Certificate Authority (CA)?

The short answer is to use the `CA.sh` or `CA.pl` script provided by OpenSSL. Unless you have a good reason not to, you should use these for preference. If you cannot, you can create a self-signed Certificate as follows:

1. Create a RSA private key for your server (will be Triple-DES encrypted and PEM formatted):

```
$ openssl genrsa -des3 -out server.key 1024
```

Please backup this `server.key` file and the pass-phrase you entered in a secure location. You can see the details of this RSA private key by using the command:

```
$ openssl rsa -noout -text -in server.key
```

If necessary, you can also create a decrypted PEM version (not recommended) of this RSA private key with:

```
$ openssl rsa -in server.key -out server.key.unsecure
```

2. Create a self-signed Certificate (X509 structure) with the RSA key you just created (output will be PEM formatted):

```
$ openssl req -new -x509 -nodes -sha1 -days 365 -key server.key -out  
server.crt
```

This signs the server CSR and results in a `server.crt` file.

You can see the details of this Certificate using:

```
$ openssl x509 -noout -text -in server.crt
```

How can I change the pass-phrase on my private key file?

You simply have to read it with the old pass-phrase and write it again, specifying the new pass-phrase. You can accomplish this with the following commands:

```
$ openssl rsa -des3 -in server.key -out server.key.new  
$ mv server.key.new server.key
```

The first time you're asked for a PEM pass-phrase, you should enter the old pass-phrase. After that, you'll be asked again to enter a pass-phrase - this time, use the new pass-phrase. If you are asked to verify the pass-phrase, you'll need to enter the new pass-phrase a second time.

How can I get rid of the pass-phrase dialog at Apache startup time?

The reason this dialog pops up at startup and every re-start is that the RSA private key inside your `server.key` file is stored in encrypted format for security reasons. The pass-phrase is needed to decrypt this file, so it can be read and parsed. Removing the pass-phrase removes a layer of security from your server - proceed with caution!

1. Remove the encryption from the RSA private key (while keeping a backup copy of the original file):

```
$ cp server.key server.key.org
```

```
$ openssl rsa -in server.key.org -out server.key
```

2. Make sure the `server.key` file is only readable by root:

```
$ chmod 400 server.key
```

Now `server.key` contains an unencrypted copy of the key. If you point your server at this file, it will not prompt you for a pass-phrase. HOWEVER, if anyone gets this key they will be able to impersonate you on the net. PLEASE make sure that the permissions on this file are such that only root or the web server user can read it (preferably get your web server to start as root but run as another user, and have the key readable only by root).

As an alternative approach you can use the “`SSLPassPhraseDialog exec:/path/to/program`” facility. Bear in mind that this is neither more nor less secure, of course.

How do I verify that a private key matches its Certificate?

A private key contains a series of numbers. Two of these numbers form the "public key", the others are part of the "private key". The "public key" bits are included when you generate a CSR, and subsequently form part of the associated Certificate.

To check that the public key in your Certificate matches the public portion of your private key, you simply need to compare these numbers. To view the Certificate and the key run the commands:

```
$ openssl x509 -noout -text -in server.crt
$ openssl rsa -noout -text -in server.key
```

The ‘modulus’ and the ‘public exponent’ portions in the key and the Certificate must match. As the public exponent is usually 65537 and it’s difficult to visually check that the long modulus numbers are the same, you can use the following approach:

```
$ openssl x509 -noout -modulus -in server.crt | openssl md5
$ openssl rsa -noout -modulus -in server.key | openssl md5
```

This leaves you with two rather shorter numbers to compare. It is, in theory, possible that these numbers may be the same, without the modulus numbers being the same, but the chances of this are overwhelmingly remote.

Should you wish to check to which key or certificate a particular CSR belongs you can perform the same calculation on the CSR as follows:

```
$ openssl req -noout -modulus -in server.csr | openssl md5
```

Why do connections fail with an "alert bad certificate" error?

Errors such as `OpenSSL: error:14094412: SSL routines:SSL3_READ_BYTES:sslv3 alert bad certificate` in the SSL logfile, are usually caused a browser which is unable to handle the server certificate/private-key. For example, Netscape Navigator 3.x is unable to handle RSA key lengths not equal to 1024 bits.

Why does my 2048-bit private key not work?

The private key sizes for SSL must be either 512 or 1024 bits, for compatibility with certain web browsers. A keysize of 1024 bits is recommended because keys larger than 1024 bits are incompatible with some versions of Netscape Navigator and Microsoft Internet Explorer, and with other browsers that use RSA’s BSAFE cryptography toolkit.

Why is client authentication broken after upgrading from SSLeay version 0.8 to 0.9?

The CA certificates under the path you configured with `SSLCACertificatePath` are found by SSLeay through hash symlinks. These hash values are generated by the ‘`openssl x509 -noout -hash`’ command. However, the algorithm used to calculate the hash for a certificate changed between SSLeay 0.8 and 0.9. You will need to remove all old hash symlinks and create new ones after upgrading. Use the `Makefile` provided by [MOD_SSL](#).

How can I convert a certificate from PEM to DER format?

The default certificate format for SSLeay/OpenSSL is PEM, which is simply Base64 encoded DER, with header and footer lines. For some applications (e.g. Microsoft Internet Explorer) you need the certificate in plain DER format. You can convert a PEM file `cert.pem` into the corresponding DER file `cert.der` using the following command:

```
$ openssl x509 -in cert.pem -out cert.der -outform DER
```

Why can't I find the `getca` or `getverisign` programs mentioned by Verisign, for installing my Verisign certificate?

Verisign has never provided specific instructions for Apache+`mod_ssl`. The instructions provided are for C2Net's Stronghold (a commercial Apache based server with SSL support).

To install your certificate, all you need to do is to save the certificate to a file, and give the name of that file to the `SSLCERTIFICATEFILE` directive. You will also need to give it the key file. For more information, see the `SSLCERTIFICATEKEYFILE` directive.

Can I use the Server Gated Cryptography (SGC) facility (aka Verisign Global ID) with `mod_ssl`?

Yes. `MOD_SSL` has included support for the SGC facility since version 2.1. No special configuration is required - just use the Global ID as your server certificate. The *step up* of the clients is then automatically handled by `MOD_SSL` at run-time.

Why do browsers complain that they cannot verify my Verisign Global ID server certificate?

Verisign uses an intermediate CA certificate between the root CA certificate (which is installed in the browsers) and the server certificate (which you installed on the server). You should have received this additional CA certificate from Verisign. If not, complain to them. Then, configure this certificate with the `SSLCERTIFICATECHAINFILE` directive. This ensures that the intermediate CA certificate is sent to the browser, filling the gap in the certificate chain.

The SSL Protocol

- Why do I get lots of random SSL protocol errors under heavy server load?
- Why does my webserver have a higher load, now that it serves SSL encrypted traffic?
- Why do HTTPS connections to my server sometimes take up to 30 seconds to establish a connection?
- What SSL Ciphers are supported by `mod_ssl`?
- Why do I get "no shared cipher" errors, when trying to use Anonymous Diffie-Hellman (ADH) ciphers?
- Why do I get a 'no shared ciphers' error when connecting to my newly installed server?
- Why can't I use SSL with name-based/non-IP-based virtual hosts?
- Why is it not possible to use Name-Based Virtual Hosting to identify different SSL virtual hosts?
- When I use Basic Authentication over HTTPS the lock icon in Netscape browsers stays unlocked when the dialog pops up. Does this mean the username/password is being sent unencrypted?
- Why do I get I/O errors when connecting via HTTPS to an Apache+`mod_ssl` server with Microsoft Internet Explorer (MSIE)?
- Why do I get I/O errors, or the message "Netscape has encountered bad data from the server", when connecting via HTTPS to an Apache+`mod_ssl` server with Netscape Navigator?

Why do I get lots of random SSL protocol errors under heavy server load?

There can be a number of reasons for this, but the main one is problems with the SSL session Cache specified by the `SSLSESSIONCACHE` directive. The DBM session cache is the most likely source of the problem, so using the SHM session cache (or no cache at all) may help.

Why does my webserver have a higher load, now that it serves SSL encrypted traffic?

SSL uses strong cryptographic encryption, which necessitates a lot of number crunching. When you request a webpage via HTTPS, everything (even the images) is encrypted before it is transferred. So increased HTTPS traffic leads to load increases.

Why do HTTPS connections to my server sometimes take up to 30 seconds to establish a connection?

This is usually caused by a `/dev/random` device for `SSLRANDOMSEED` which blocks the `read(2)` call until enough entropy is available to service the request. More information is available in the reference manual for the `SSLRANDOMSEED` directive.

What SSL Ciphers are supported by `mod_ssl`?

Usually, any SSL ciphers supported by the version of OpenSSL in use, are also supported by `MOD_SSL`. Which ciphers are available can depend on the way you built OpenSSL. Typically, at least the following ciphers are supported:

1. RC4 with MD5
2. RC4 with MD5 (export version restricted to 40-bit key)
3. RC2 with MD5
4. RC2 with MD5 (export version restricted to 40-bit key)
5. IDEA with MD5
6. DES with MD5
7. Triple-DES with MD5

To determine the actual list of ciphers available, you should run the following:

```
$ openssl ciphers -v
```

Why do I get “no shared cipher” errors, when trying to use Anonymous Diffie-Hellman (ADH) ciphers?

By default, OpenSSL does *not* allow ADH ciphers, for security reasons. Please be sure you are aware of the potential side-effects if you choose to enable these ciphers.

In order to use Anonymous Diffie-Hellman (ADH) ciphers, you must build OpenSSL with “`-DSSL_ALLOW_ADH`”, and then add “ADH” into your `SSLCIPHERSUITE`.

Why do I get a 'no shared ciphers' error when connecting to my newly installed server?

Either you have made a mistake with your `>SSLCIPHERSUITE` directive (compare it with the pre-configured example in `httpd.conf-dist`) or you chose to use DSA/DH algorithms instead of RSA when you generated your private key and ignored or overlooked the warnings. If you have chosen DSA/DH, then your server cannot communicate using RSA-based SSL ciphers (at least until you configure an additional RSA-based certificate/key pair). Modern browsers like NS or IE can only communicate over SSL using RSA ciphers. The result is the "no shared ciphers" error. To fix this, regenerate your server certificate/key pair, using the RSA algorithm.

Why can't I use SSL with name-based/non-IP-based virtual hosts?

The reason is very technical, and a somewhat "chicken and egg" problem. The SSL protocol layer stays below the HTTP protocol layer and encapsulates HTTP. When an SSL connection (HTTPS) is established Apache/mod_ssl has to negotiate the SSL protocol parameters with the client. For this, mod_ssl has to consult the configuration of the virtual server (for instance it has to look for the cipher suite, the server certificate, etc.). But in order to go to the correct virtual server Apache has to know the `Host` HTTP header field. To do this, the HTTP request header has to be read. This cannot be done before the SSL handshake is finished, but the information is needed in order to complete the SSL handshake phase. Bingo!

Why is it not possible to use Name-Based Virtual Hosting to identify different SSL virtual hosts?

Name-Based Virtual Hosting is a very popular method of identifying different virtual hosts. It allows you to use the same IP address and the same port number for many different sites. When people move on to SSL, it seems natural to assume that the same method can be used to have lots of different SSL virtual hosts on the same server.

It comes as rather a shock to learn that it is impossible.

The reason is that the SSL protocol is a separate layer which encapsulates the HTTP protocol. So the SSL session is a separate transaction, that takes place before the HTTP session has begun. The server receives an SSL request on IP address X and port Y (usually 443). Since the SSL request does not contain any `Host:` field, the server has no way to decide which SSL virtual host to use. Usually, it will just use the first one it finds, which matches the port and IP address specified.

You can, of course, use Name-Based Virtual Hosting to identify many non-SSL virtual hosts (all on port 80, for example) and then have a single SSL virtual host (on port 443). But if you do this, you must make sure to put the non-SSL port number on the `NameVirtualHost` directive, e.g.

```
NameVirtualHost 192.168.1.1:80
```

Other workaround solutions include:

Using separate IP addresses for different SSL hosts. Using different port numbers for different SSL hosts.

How do I get SSL compression working?

Although SSL compression negotiation was defined in the specification of SSLv2 and TLS, it took until May 2004 for RFC 3749 to define DEFLATE as a negotiable standard compression method.

OpenSSL 0.9.8 started to support this by default when compiled with the `zlib` option. If both the client and the server support compression, it will be used. However, most clients still try to initially connect with an SSLv2 Hello. As SSLv2 did not include an array of preferred compression algorithms in its handshake, compression cannot be negotiated with these clients. If the client disables support for SSLv2, either an SSLv3 or TLS Hello may be sent, depending on which SSL library is used, and compression may be set up. You can verify whether clients make use of SSL compression by logging the `%{SSL_COMPRESS_METHOD}x` variable.

When I use Basic Authentication over HTTPS the lock icon in Netscape browsers stays unlocked when the dialog pops up. Does this mean the username/password is being sent unencrypted?

No, the username/password is transmitted encrypted. The icon in Netscape browsers is not actually synchronized with the SSL/TLS layer. It only toggles to the locked state when the first part of the actual webpage data is transferred, which may confuse people. The Basic Authentication facility is part of the HTTP layer, which is above the SSL/TLS layer in HTTPS. Before any HTTP data communication takes place in HTTPS, the SSL/TLS layer has already completed its handshake phase, and switched to encrypted communication. So don't be confused by this icon.

Why do I get I/O errors when connecting via HTTPS to an Apache+mod_ssl server with Microsoft Internet Explorer (MSIE)?

The first reason is that the SSL implementation in some MSIE versions has some subtle bugs related to the HTTP keep-alive facility and the SSL close notify alerts on socket connection close. Additionally the interaction between SSL and HTTP/1.1 features are problematic in some MSIE versions. You can work around these problems by forcing Apache not to use HTTP/1.1, keep-alive connections or send the SSL close notify messages to MSIE clients. This can be done by using the following directive in your SSL-aware virtual host section:

```
SetEnvIf User-Agent ".*MSIE.*" \
nokeepalive ssl-unclean-shutdown \
downgrade-1.0 force-response-1.0
```

Further, some MSIE versions have problems with particular ciphers. Unfortunately, it is not possible to implement a MSIE-specific workaround for this, because the ciphers are needed as early as the SSL handshake phase. So a MSIE-specific `SETENVIF` won't solve these problems. Instead, you will have to make more drastic adjustments to the global parameters. Before you decide to do this, make sure your clients really have problems. If not, do not make these changes - they will affect *all* your clients, MSIE or otherwise.

The next problem is that 56bit export versions of MSIE 5.x browsers have a broken SSLv3 implementation, which interacts badly with OpenSSL versions greater than 0.9.4. You can accept this and require your clients to upgrade their browsers, you can downgrade to OpenSSL 0.9.4 (not advised), or you can work around this, accepting that your workaround will affect other browsers too:

```
SSLProtocol all -SSLv3
```

will completely disables the SSLv3 protocol and allow those browsers to work. A better workaround is to disable only those ciphers which cause trouble.

```
SSLCipherSuite
ALL:!ADH:!EXPORT56:RC4+RSA:+HIGH:+MEDIUM:+LOW:+SSLv2:+EXP
```

This also allows the broken MSIE versions to work, but only removes the newer 56bit TLS ciphers.

Another problem with MSIE 5.x clients is that they refuse to connect to URLs of the form `https://12.34.56.78/` (where IP-addresses are used instead of the hostname), if the server is using the Server Gated Cryptography (SGC) facility. This can only be avoided by using the fully qualified domain name (FQDN) of the website in hyperlinks instead, because MSIE 5.x has an error in the way it handles the SGC negotiation.

And finally there are versions of MSIE which seem to require that an SSL session can be reused (a totally non standard-conforming behaviour, of course). Connecting with those MSIE versions only work if a SSL session cache is used. So, as a work-around, make sure you are using a session cache (see the `SSLSESSIONCACHE` directive).

Why do I get I/O errors, or the message "Netscape has encountered bad data from the server", when connecting via HTTPS to an Apache+mod_ssl server with Netscape Navigator?

This usually occurs when you have created a new server certificate for a given domain, but had previously told your browser to always accept the old server certificate. Once you clear the entry for the old certificate from your browser, everything should be fine. Netscape's SSL implementation is correct, so when you encounter I/O errors with Netscape Navigator it is usually caused by the configured certificates.

mod_ssl Support

- What information resources are available in case of mod_ssl problems?
- What support contacts are available in case of mod_ssl problems?
- What information should I provide when writing a bug report?
- I had a core dump, can you help me?
- How do I get a backtrace, to help find the reason for my core dump?

What information resources are available in case of mod_ssl problems?

The following information resources are available. In case of problems you should search here first.

Answers in the User Manual's F.A.Q. List (this) http://httpd.apache.org/docs/2.0/ssl/ssl_faq.html²⁴

First check the F.A.Q. (this text). If your problem is a common one, it may have been answered several times before, and been included in this doc.

Postings from the modssl-users Support Mailing List <http://www.modssl.org/support/> Search for your problem in the archives of the modssl-users mailing list. You're probably not the first person to have had this problem!

What support contacts are available in case of mod_ssl problems?

The following lists all support possibilities for mod_ssl, in order of preference. Please go through these possibilities *in this order* - don't just pick the one you like the look of.

1. *Send a Problem Report to the modssl-users Support Mailing List*

modssl-users@modssl.org²⁵

This is the preferred way of submitting your problem report, because this way, others can see the problem, and learn from any answers. You must subscribe to the list first, but you can then easily discuss your problem with both the author and the whole mod_ssl user community.

2. *Send a Problem Report to the Apache httpd Users Support Mailing List*

users@httpd.apache.org²⁶

This is the second way of submitting your problem report. Again, you must subscribe to the list first, but you can then easily discuss your problem with the whole Apache httpd user community.

3. *Write a Problem Report in the Bug Database*

http://httpd.apache.org/bug_report.html²⁷

²⁴http://httpd.apache.org/docs/2.0/ssl/ssl_faq.html

²⁵<mailto:modssl-users@modssl.org>

²⁶<mailto:users@httpd.apache.org>

²⁷http://httpd.apache.org/bug_report.html

This is the last way of submitting your problem report. You should only do this if you've already posted to the mailing lists, and had no success. Please follow the instructions on the above page *carefully*.

What information should I provide when writing a bug report?

You should always provide at least the following information:

Apache and OpenSSL version information The Apache version can be determined by running `httpd -v`. The OpenSSL version can be determined by running `openssl version`. Alternatively, if you have Lynx installed, you can run the command `lynx -mime_header http://localhost/ | grep Server` to gather this information in a single step.

The details on how you built and installed Apache+mod_ssl+OpenSSL For this you can provide a logfile of your terminal session which shows the configuration and install steps. If this is not possible, you should at least provide the configure command line you used.

In case of core dumps please include a Backtrace If your Apache+mod_ssl+OpenSSL dumps its core, please attach a stack-frame "backtrace" (see below for information on how to get this). Without this information, the reason for your core dump cannot be found

A detailed description of your problem Don't laugh, we really mean it! Many problem reports don't include a description of what the actual problem is. Without this, it's very difficult for anyone to help you. So, it's in your own interest (you want the problem be solved, don't you?) to include as much detail as possible, please. Of course, you should still include all the essentials above too.

I had a core dump, can you help me?

In general no, at least not unless you provide more details about the code location where Apache dumped core. What is usually always required in order to help you is a backtrace (see next question). Without this information it is mostly impossible to find the problem and help you in fixing it.

How do I get a backtrace, to help find the reason for my core dump?

Following are the steps you will need to complete, to get a backtrace:

1. Make sure you have debugging symbols available, at least in Apache. On platforms where you use GCC/GDB, you will have to build Apache+mod_ssl with "`OPTIM="-g -ggdb3"`" to get this. On other platforms at least "`OPTIM="-g"`" is needed.
2. Start the server and try to reproduce the core-dump. For this you may want to use a directive like "`CoreDumpDirectory /tmp`" to make sure that the core-dump file can be written. This should result in a `/tmp/core` or `/tmp/httpd.core` file. If you don't get one of these, try running your server under a non-root UID. Many modern kernels do not allow a process to dump core after it has done a `setuid()` (unless it does an `exec()`) for security reasons (there can be privileged information left over in memory). If necessary, you can run `/path/to/httpd -X` manually to force Apache to not fork.
3. Analyze the core-dump. For this, run `gdb /path/to/httpd /tmp/httpd.core` or a similar command. In GDB, all you have to do then is to enter `bt`, and voila, you get the backtrace. For other debuggers consult your local debugger manual.

Chapter 6

Guides, Tutorials, and HowTos

6.1 How-To / Tutorials

How-To / Tutorials

Authentication Authentication is any process by which you verify that someone is who they claim they are. Authorization is any process by which someone is allowed to be where they want to go, or to have information that they want to have.

See: Authentication, Authorization, and Access Control (p. 181)

Dynamic Content with CGI The CGI (Common Gateway Interface) defines a way for a web server to interact with external content-generating programs, which are often referred to as CGI programs or CGI scripts. It is the simplest, and most common, way to put dynamic content on your web site. This document will be an introduction to setting up CGI on your Apache web server, and getting started writing CGI programs.

See: CGI: Dynamic Content (p. 185)

.htaccess files `.htaccess` files provide a way to make configuration changes on a per-directory basis. A file, containing one or more configuration directives, is placed in a particular document directory, and the directives apply to that directory, and all subdirectories thereof.

See: `.htaccess` files (p. 197)

Introduction to Server Side Includes SSI (Server Side Includes) are directives that are placed in HTML pages, and evaluated on the server while the pages are being served. They let you add dynamically generated content to an existing HTML page, without having to serve the entire page via a CGI program, or other dynamic technology.

See: Server Side Includes (SSI) (p. 191)

Per-user web directories On systems with multiple users, each user can be permitted to have a web site in their home directory using the `USERDIR` directive. Visitors to a URL `http://example.com/~username/` will get content out of the home directory of the user "username", out of the subdirectory specified by the `USERDIR` directive.

See: User web directories (`public_html`) (p. 202)

6.2 Authentication, Authorization and Access Control

Authentication is any process by which you verify that someone is who they claim they are. Authorization is any process by which someone is allowed to be where they want to go, or to have information that they want to have.

Related Modules and Directives

Related Modules	Related Directives
MOD_AUTH	ALLOW
MOD_ACCESS	AUTHGROUPFILE
	AUTHNAME
	AUTHTYPE
	AUTHUSERFILE
	DENY
	OPTIONS
	REQUIRE

Introduction

If you have information on your web site that is sensitive or intended for only a small group of people, the techniques in this article will help you make sure that the people that see those pages are the people that you wanted to see them.

This article covers the "standard" way of protecting parts of your web site that most of you are going to use.

The Prerequisites

The directives discussed in this article will need to go either in your main server configuration file (typically in a `<DIRECTORY>` section), or in per-directory configuration files (`.htaccess` files).

If you plan to use `.htaccess` files, you will need to have a server configuration that permits putting authentication directives in these files. This is done with the `ALLOWOVERRIDE` directive, which specifies which directives, if any, may be put in per-directory configuration files.

Since we're talking here about authentication, you will need an `ALLOWOVERRIDE` directive like the following:

```
AllowOverride AuthConfig
```

Or, if you are just going to put the directives directly in your main server configuration file, you will of course need to have write permission to that file.

And you'll need to know a little bit about the directory structure of your server, in order to know where some files are kept. This should not be terribly difficult, and I'll try to make this clear when we come to that point.

Getting it working

Here's the basics of password protecting a directory on your server.

You'll need to create a password file. This file should be placed somewhere not accessible from the web. This is so that folks cannot download the password file. For example, if your documents are served out of `/usr/local/apache/htdocs` you might want to put the password file(s) in `/usr/local/apache/passwd`.

To create the file, use the `htpasswd` utility that came with Apache. This will be located in the `bin` directory of wherever you installed Apache. To create the file, type:

```
htpasswd -c /usr/local/apache/passwd/passwords rbowen
```

`htpasswd` will ask you for the password, and then ask you to type it again to confirm it:

```
# htpasswd -c /usr/local/apache/passwd/passwords rbowen
New password: mypassword
Re-type new password: mypassword
Adding password for user rbowen
```

If `htpasswd` is not in your path, of course you'll have to type the full path to the file to get it to run. On my server, it's located at `/usr/local/apache/bin/htpasswd`

Next, you'll need to configure the server to request a password and tell the server which users are allowed access. You can do this either by editing the `httpd.conf` file or using an `.htaccess` file. For example, if you wish to protect the directory `/usr/local/apache/htdocs/secret`, you can use the following directives, either placed in the file `/usr/local/apache/htdocs/secret/.htaccess`, or placed in `httpd.conf` inside a `<Directory /usr/local/apache/apache/htdocs/secret>` section.

```
AuthType Basic
AuthName "Restricted Files"
AuthUserFile /usr/local/apache/passwd/passwords
Require user rbowen
```

Let's examine each of those directives individually. The `AUTHTYPE` directive selects that method that is used to authenticate the user. The most common method is `Basic`, and this is the method implemented by `MOD_AUTH`. It is important to be aware, however, that Basic authentication sends the password from the client to the browser unencrypted. This method should therefore not be used for highly sensitive data. Apache supports one other authentication method: `AuthType Digest`. This method is implemented by `MOD_AUTH_DIGEST` and is much more secure. Only the most recent versions of clients are known to support Digest authentication.

The `AUTHNAME` directive sets the Realm to be used in the authentication. The realm serves two major functions. First, the client often presents this information to the user as part of the password dialog box. Second, it is used by the client to determine what password to send for a given authenticated area.

So, for example, once a client has authenticated in the "Restricted Files" area, it will automatically retry the same password for any area on the same server that is marked with the "Restricted Files" Realm. Therefore, you can prevent a user from being prompted more than once for a password by letting multiple restricted areas share the same realm. Of course, for security reasons, the client will always need to ask again for the password whenever the hostname of the server changes.

The `AUTHUSERFILE` directive sets the path to the password file that we just created with `htpasswd`. If you have a large number of users, it can be quite slow to search through a plain text file to authenticate the user on each request. Apache also has the ability to store user information in fast database files. The `MOD_AUTH_DBM` module provides the `AUTHDBMUSERFILE` directive. These files can be created and manipulated with the `dbmmanage` program. Many other types of authentication options are available from third party modules in the Apache Modules Database¹.

Finally, the `REQUIRE` directive provides the authorization part of the process by setting the user that is allowed to access this region of the server. In the next section, we discuss various ways to use the `REQUIRE` directive.

¹<http://modules.apache.org/>

Letting more than one person in

The directives above only let one person (specifically someone with a username of `rbowen`) into the directory. In most cases, you'll want to let more than one person in. This is where the [AUTHGROUPFILE](#) comes in.

If you want to let more than one person in, you'll need to create a group file that associates group names with a list of users in that group. The format of this file is pretty simple, and you can create it with your favorite editor. The contents of the file will look like this:

```
GroupName: rbowen dpitts sungo rshersey
```

That's just a list of the members of the group in a long line separated by spaces.

To add a user to your already existing password file, type:

```
htpasswd /usr/local/apache/passwd/passwords dpitts
```

You'll get the same response as before, but it will be appended to the existing file, rather than creating a new file. (It's the `-c` that makes it create a new password file).

Now, you need to modify your `.htaccess` file to look like the following:

```
AuthType Basic
AuthName "By Invitation Only"
AuthUserFile /usr/local/apache/passwd/passwords
AuthGroupFile /usr/local/apache/passwd/groups
Require group GroupName
```

Now, anyone that is listed in the group `GroupName`, and has an entry in the `password` file, will be let in, if they type the correct password.

There's another way to let multiple users in that is less specific. Rather than creating a group file, you can just use the following directive:

```
Require valid-user
```

Using that rather than the `Require user rbowen` line will allow anyone in that is listed in the password file, and who correctly enters their password. You can even emulate the group behavior here, by just keeping a separate password file for each group. The advantage of this approach is that Apache only has to check one file, rather than two. The disadvantage is that you have to maintain a bunch of password files, and remember to reference the right one in the [AUTHUSERFILE](#) directive.

Possible problems

Because of the way that Basic authentication is specified, your username and password must be verified every time you request a document from the server. This is even if you're reloading the same page, and for every image on the page (if they come from a protected directory). As you can imagine, this slows things down a little. The amount that it slows things down is proportional to the size of the password file, because it has to open up that file, and go down the list of users until it gets to your name. And it has to do this every time a page is loaded.

A consequence of this is that there's a practical limit to how many users you can put in one password file. This limit will vary depending on the performance of your particular server machine, but you can expect to see slowdowns once you get above a few hundred entries, and may wish to consider a different authentication method at that time.

What other neat stuff can I do?

Authentication by username and password is only part of the story. Frequently you want to let people in based on something other than who they are. Something such as where they are coming from.

The [ALLOW](#) and [DENY](#) directives let you allow and deny access based on the host name, or host address, of the machine requesting a document. The [ORDER](#) directive goes hand-in-hand with these two, and tells Apache in which order to apply the filters.

The usage of these directives is:

```
Allow from address
```

where address is an IP address (or a partial IP address) or a fully qualified domain name (or a partial domain name); you may provide multiple addresses or domain names, if desired.

For example, if you have someone spamming your message board, and you want to keep them out, you could do the following:

```
Deny from 10.252.46.165
```

Visitors coming from that address will not be able to see the content covered by this directive. If, instead, you have a machine name, rather than an IP address, you can use that.

```
Deny from host.example.com
```

And, if you'd like to block access from an entire domain, you can specify just part of an address or domain name:

```
Deny from 192.168.205
Deny from phishers.example.com moreidiots.example
Deny from ke
```

Using [ORDER](#) will let you be sure that you are actually restricting things to the group that you want to let in, by combining a [DENY](#) and an [ALLOW](#) directive:

```
Order deny,allow
Deny from all
Allow from dev.example.com
```

Listing just the [ALLOW](#) directive would not do what you want, because it will let folks from that host in, in addition to letting everyone in. What you want is to let *only* those folks in.

More information

You should also read the documentation for [MOD_AUTH](#) and [MOD_ACCESS](#) which contain some more information about how this all works.

6.3 Apache Tutorial: Dynamic Content with CGI

Introduction

Related Modules	Related Directives
MOD_ALIAS	ADDFHANDLER
MOD_CGI	OPTIONS
	SCRIPTALIAS

The CGI (Common Gateway Interface) defines a way for a web server to interact with external content-generating programs, which are often referred to as CGI programs or CGI scripts. It is the simplest, and most common, way to put dynamic content on your web site. This document will be an introduction to setting up CGI on your Apache web server, and getting started writing CGI programs.

Configuring Apache to permit CGI

In order to get your CGI programs to work properly, you'll need to have Apache configured to permit CGI execution. There are several ways to do this.

ScriptAlias

The [SCRIPTALIAS](#)

directive tells Apache that a particular directory is set aside for CGI programs. Apache will assume that every file in this directory is a CGI program, and will attempt to execute it, when that particular resource is requested by a client.

The [SCRIPTALIAS](#) directive looks like:

```
ScriptAlias /cgi-bin/ /usr/local/apache2/cgi-bin/
```

The example shown is from your default `httpd.conf` configuration file, if you installed Apache in the default location. The [SCRIPTALIAS](#) directive is much like the [ALIAS](#) directive, which defines a URL prefix that is mapped to a particular directory. [ALIAS](#) and [SCRIPTALIAS](#) are usually used for directories that are outside of the [DOCUMENTROOT](#) directory. The difference between [ALIAS](#) and [SCRIPTALIAS](#) is that [SCRIPTALIAS](#) has the added meaning that everything under that URL prefix will be considered a CGI program. So, the example above tells Apache that any request for a resource beginning with `/cgi-bin/` should be served from the directory `/usr/local/apache2/cgi-bin/`, and should be treated as a CGI program.

For example, if the URL `http://www.example.com/cgi-bin/test.pl` is requested, Apache will attempt to execute the file `/usr/local/apache2/cgi-bin/test.pl` and return the output. Of course, the file will have to exist, and be executable, and return output in a particular way, or Apache will return an error message.

CGI outside of ScriptAlias directories

CGI programs are often restricted to [SCRIPTALIAS](#)'ed directories for security reasons. In this way, administrators can tightly control who is allowed to use CGI programs. However, if the proper security precautions are taken, there is no reason why CGI programs cannot be run from arbitrary directories. For example, you may wish to let users have web content in their home directories with the [USERDIR](#) directive. If they want to have their own CGI programs, but don't have access to the main `cgi-bin` directory, they will need to be able to run CGI programs elsewhere.

There are two steps to allowing CGI execution in an arbitrary directory. First, the `cgi-script` handler must be activated using the [ADDFHANDLER](#) or [SETHANDLER](#) directive. Second, `ExecCGI` must be specified in the [OPTIONS](#) directive.

Explicitly using Options to permit CGI execution

You could explicitly use the **OPTIONS** directive, inside your main server configuration file, to specify that CGI execution was permitted in a particular directory:

```
<Directory /usr/local/apache2/htdocs/somedir>
    Options +ExecCGI
</Directory>
```

The above directive tells Apache to permit the execution of CGI files. You will also need to tell the server what files are CGI files. The following **ADDFHANDLER** directive tells the server to treat all files with the `cgi` or `pl` extension as CGI programs:

```
AddHandler cgi-script .cgi .pl
```

.htaccess files

The `.htaccess` tutorial (p. 197) shows how to activate CGI programs if you do not have access to `httpd.conf`.

User Directories

To allow CGI program execution for any file ending in `.cgi` in users' directories, you can use the following configuration.

```
<Directory /home/*/public_html>
    Options +ExecCGI
    AddHandler cgi-script .cgi
</Directory>
```

If you wish designate a `cgi-bin` subdirectory of a user's directory where everything will be treated as a CGI program, you can use the following.

```
<Directory /home/*/public_html/cgi-bin>
    Options ExecCGI
    SetHandler cgi-script
</Directory>
```

Writing a CGI program

There are two main differences between "regular" programming, and CGI programming.

First, all output from your CGI program must be preceded by a MIME-type header. This is HTTP header that tells the client what sort of content it is receiving. Most of the time, this will look like:

```
Content-type: text/html
```

Secondly, your output needs to be in HTML, or some other format that a browser will be able to display. Most of the time, this will be HTML, but occasionally you might write a CGI program that outputs a gif image, or other non-HTML content.

Apart from those two things, writing a CGI program will look a lot like any other program that you might write.

Your first CGI program

The following is an example CGI program that prints one line to your browser. Type in the following, save it to a file called `first.pl`, and put it in your `cgi-bin` directory.

```
#!/usr/bin/perl
print "Content-type: text/html\n\n";
print "Hello, World.";
```

Even if you are not familiar with Perl, you should be able to see what is happening here. The first line tells Apache (or whatever shell you happen to be running under) that this program can be executed by feeding the file to the interpreter found at the location `/usr/bin/perl`. The second line prints the content-type declaration we talked about, followed by two carriage-return newline pairs. This puts a blank line after the header, to indicate the end of the HTTP headers, and the beginning of the body. The third line prints the string "Hello, World.". And that's the end of it.

If you open your favorite browser and tell it to get the address

```
http://www.example.com/cgi-bin/first.pl
```

or wherever you put your file, you will see the one line `Hello, World.` appear in your browser window. It's not very exciting, but once you get that working, you'll have a good chance of getting just about anything working.

But it's still not working!

There are four basic things that you may see in your browser when you try to access your CGI program from the web:

The output of your CGI program Great! That means everything worked fine. If the output is correct, but the browser is not processing it correctly, make sure you have the correct `Content-Type` set in your CGI program.

The source code of your CGI program or a "POST Method Not Allowed" message That means that you have not properly configured Apache to process your CGI program. Reread the section on configuring Apache and try to find what you missed.

A message starting with "Forbidden" That means that there is a permissions problem. Check the Apache error log and the section below on file permissions.

A message saying "Internal Server Error" If you check the Apache error log, you will probably find that it says "Premature end of script headers", possibly along with an error message generated by your CGI program. In this case, you will want to check each of the below sections to see what might be preventing your CGI program from emitting the proper HTTP headers.

File permissions

Remember that the server does not run as you. That is, when the server starts up, it is running with the permissions of an unprivileged user - usually `nobody`, or `www` - and so it will need extra permissions to execute files that are owned by you. Usually, the way to give a file sufficient permissions to be executed by `nobody` is to give everyone execute permission on the file:

```
chmod a+x first.pl
```

Also, if your program reads from, or writes to, any other files, those files will need to have the correct permissions to permit this.

Path information and environment

When you run a program from your command line, you have certain information that is passed to the shell without you thinking about it. For example, you have a `PATH`, which tells the shell where it can look for files that you reference.

When a program runs through the web server as a CGI program, it may not have the same `PATH`. Any programs that you invoke in your CGI program (like `sendmail`, for example) will need to be specified by a full path, so that the shell can find them when it attempts to execute your CGI program.

A common manifestation of this is the path to the script interpreter (often `perl`) indicated in the first line of your CGI program, which will look something like:

```
#!/usr/bin/perl
```

Make sure that this is in fact the path to the interpreter.

In addition, if your CGI program depends on other environment variables, you will need to assure that those variables are passed by Apache.

Program errors

Most of the time when a CGI program fails, it's because of a problem with the program itself. This is particularly true once you get the hang of this CGI stuff, and no longer make the above two mistakes. The first thing to do is to make sure that your program runs from the command line before testing it via the web server. For example, try:

```
cd /usr/local/apache2/cgi-bin  
./first.pl
```

(Do not call the `perl` interpreter. The shell and Apache should find the interpreter using the path information on the first line of the script.)

The first thing you see written by your program should be a set of HTTP headers, including the `Content-Type`, followed by a blank line. If you see anything else, Apache will return the `Premature end of script headers` error if you try to run it through the server. See Writing a CGI program above for more details.

Error logs

The error logs are your friend. Anything that goes wrong generates message in the error log. You should always look there first. If the place where you are hosting your web site does not permit you access to the error log, you should probably host your site somewhere else. Learn to read the error logs, and you'll find that almost all of your problems are quickly identified, and quickly solved.

Suexec

The `suexec` (p. 68) support program allows CGI programs to be run under different user permissions, depending on which virtual host or user home directory they are located in. `Suexec` has very strict permission checking, and any failure in that checking will result in your CGI programs failing with `Premature end of script headers`.

To check if you are using `suexec`, run `apachectl -V` and check for the location of `SUEXEC_BIN`. If Apache finds an `suexec` binary there on startup, `suexec` will be activated.

Unless you fully understand `suexec`, you should not be using it. To disable `suexec`, simply remove (or rename) the `suexec` binary pointed to by `SUEXEC_BIN` and then restart the server. If, after reading about `suexec` (p. 68), you still wish to use it, then run `suexec -V` to find the location of the `suexec` log file, and use that log file to find what policy you are violating.

What's going on behind the scenes?

As you become more advanced in CGI programming, it will become useful to understand more about what's happening behind the scenes. Specifically, how the browser and server communicate with one another. Because although it's all very well to write a program that prints "Hello, World.", it's not particularly useful.

Environment variables

Environment variables are values that float around you as you use your computer. They are useful things like your path (where the computer searches for the actual file implementing a command when you type it), your username, your terminal type, and so on. For a full list of your normal, every day environment variables, type `env` at a command prompt.

During the CGI transaction, the server and the browser also set environment variables, so that they can communicate with one another. These are things like the browser type (Netscape, IE, Lynx), the server type (Apache, IIS, WebSite), the name of the CGI program that is being run, and so on.

These variables are available to the CGI programmer, and are half of the story of the client-server communication. The complete list of required variables is at <http://hoohoo.ncsa.uiuc.edu/cgi/env.html>.

This simple Perl CGI program will display all of the environment variables that are being passed around. Two similar programs are included in the `cgi-bin`

directory of the Apache distribution. Note that some variables are required, while others are optional, so you may see some variables listed that were not in the official list. In addition, Apache provides many different ways for you to add your own environment variables (p. 60) to the basic ones provided by default.

```
#!/usr/bin/perl
print "Content-type: text/html\n\n";
foreach $key (keys %ENV) {
    print "$key --> $ENV{$key}<br>";
}
```

STDIN and STDOUT

Other communication between the server and the client happens over standard input (STDIN) and standard output (STDOUT). In normal everyday context, STDIN means the keyboard, or a file that a program is given to act on, and STDOUT usually means the console or screen.

When you `POST` a web form to a CGI program, the data in that form is bundled up into a special format and gets delivered to your CGI program over STDIN. The program then can process that data as though it was coming in from the keyboard, or from a file

The "special format" is very simple. A field name and its value are joined together with an equals (=) sign, and pairs of values are joined together with an ampersand (&). Inconvenient characters like spaces, ampersands, and equals signs, are converted into their hex equivalent so that they don't gum up the works. The whole data string might look something like:

```
name=Rich%20Bowen&city=Lexington&state=KY&sidekick=Squirrel%20Monkey
```

You'll sometimes also see this type of string appended to a URL. When that is done, the server puts that string into the environment variable called `QUERY_STRING`. That's called a `GET` request. Your HTML form specifies whether a `GET` or a `POST` is used to deliver the data, by setting the `METHOD` attribute in the `FORM` tag.

Your program is then responsible for splitting that string up into useful information. Fortunately, there are libraries and modules available to help you process this data, as well as handle other of the aspects of your CGI program.

CGI modules/libraries

When you write CGI programs, you should consider using a code library, or module, to do most of the grunt work for you. This leads to fewer errors, and faster development.

If you're writing CGI programs in Perl, modules are available on CPAN². The most popular module for this purpose is `CGI.pm`. You might also consider `CGI::Lite`, which implements a minimal set of functionality, which is all you need in most programs.

If you're writing CGI programs in C, there are a variety of options. One of these is the `CGIC` library, from <http://www.boutell.com/cgic/>.

For more information

There are a large number of CGI resources on the web. You can discuss CGI problems with other users on the Usenet group comp.infosystems.www.authoring.cgi³. And the `-servers` mailing list from the HTML Writers Guild is a great source of answers to your questions. You can find out more at <http://www.hwg.org/lists/hwg-servers/>.

And, of course, you should probably read the CGI specification, which has all the details on the operation of CGI programs. You can find the original version at the NCSA⁴ and there is an updated draft at the Common Gateway Interface RFC project⁵.

When you post a question about a CGI problem that you're having, whether to a mailing list, or to a newsgroup, make sure you provide enough information about what happened, what you expected to happen, and how what actually happened was different, what server you're running, what language your CGI program was in, and, if possible, the offending code. This will make finding your problem much simpler.

Note that questions about CGI problems should **never** be posted to the Apache bug database unless you are sure you have found a problem in the Apache source code.

²<http://www.cpan.org/>

³news:comp.infosystems.www.authoring.cgi

⁴<http://hoohoo.ncsa.uiuc.edu/cgi/interface.html>

⁵<http://web.golux.com/coar/cgi/>

6.4 Apache Tutorial: Introduction to Server Side Includes

Server-side includes provide a means to add dynamic content to existing HTML documents.

Introduction

Related Modules	Related Directives
MOD_INCLUDE	OPTIONS
MOD_CGI	XBITHACK
MOD_EXPIRES	ADDTYPE
	SETOUTPUTFILTER
	BROWSERMATCHNOCASE

This article deals with Server Side Includes, usually called simply SSI. In this article, I'll talk about configuring your server to permit SSI, and introduce some basic SSI techniques for adding dynamic content to your existing HTML pages.

In the latter part of the article, we'll talk about some of the somewhat more advanced things that can be done with SSI, such as conditional statements in your SSI directives.

What are SSI?

SSI (Server Side Includes) are directives that are placed in HTML pages, and evaluated on the server while the pages are being served. They let you add dynamically generated content to an existing HTML page, without having to serve the entire page via a CGI program, or other dynamic technology.

The decision of when to use SSI, and when to have your page entirely generated by some program, is usually a matter of how much of the page is static, and how much needs to be recalculated every time the page is served. SSI is a great way to add small pieces of information, such as the current time. But if a majority of your page is being generated at the time that it is served, you need to look for some other solution.

Configuring your server to permit SSI

To permit SSI on your server, you must have the following directive either in your `httpd.conf` file, or in a `.htaccess` file:

```
Options +Includes
```

This tells Apache that you want to permit files to be parsed for SSI directives. Note that most configurations contain multiple `OPTIONS` directives that can override each other. You will probably need to apply the `Options` to the specific directory where you want SSI enabled in order to assure that it gets evaluated last.

Not just any file is parsed for SSI directives. You have to tell Apache which files should be parsed. There are two ways to do this. You can tell Apache to parse any file with a particular file extension, such as `.shtml`, with the following directives:

```
AddType text/html .shtml
AddOutputFilter INCLUDES .shtml
```

One disadvantage to this approach is that if you wanted to add SSI directives to an existing page, you would have to change the name of that page, and all links to that page, in order to give it a `.shtml` extension, so that those directives would be executed.

The other method is to use the `XBitHack` directive:

```
XBitHack on
```

`XBitHack` tells Apache to parse files for SSI directives if they have the execute bit set. So, to add SSI directives to an existing page, rather than having to change the file name, you would just need to make the file executable using `chmod`.

```
chmod +x pagename.html
```

A brief comment about what not to do. You'll occasionally see people recommending that you just tell Apache to parse all `.html` files for SSI, so that you don't have to mess with `.shtml` file names. These folks have perhaps not heard about `XBitHack`. The thing to keep in mind is that, by doing this, you're requiring that Apache read through every single file that it sends out to clients, even if they don't contain any SSI directives. This can slow things down quite a bit, and is not a good idea.

Of course, on Windows, there is no such thing as an execute bit to set, so that limits your options a little.

In its default configuration, Apache does not send the last modified date or content length HTTP headers on SSI pages, because these values are difficult to calculate for dynamic content. This can prevent your document from being cached, and result in slower perceived client performance. There are two ways to solve this:

1. Use the `XBitHack Full` configuration. This tells Apache to determine the last modified date by looking only at the date of the originally requested file, ignoring the modification date of any included files.
2. Use the directives provided by `MOD_EXPIRES` to set an explicit expiration time on your files, thereby letting browsers and proxies know that it is acceptable to cache them.

Basic SSI directives

SSI directives have the following syntax:

```
<!--#element attribute=value attribute=value ... -->
```

It is formatted like an HTML comment, so if you don't have SSI correctly enabled, the browser will ignore it, but it will still be visible in the HTML source. If you have SSI correctly configured, the directive will be replaced with its results.

The element can be one of a number of things, and we'll talk some more about most of these in the next installment of this series. For now, here are some examples of what you can do with SSI

Today's date

```
<!--#echo var="DATE_LOCAL" -->
```

The `echo` element just spits out the value of a variable. There are a number of standard variables, which include the whole set of environment variables that are available to CGI programs. Also, you can define your own variables with the `set` element.

If you don't like the format in which the date gets printed, you can use the `config` element, with a `timefmt` attribute, to modify that formatting.

```
<!--#config timefmt="%A %B %d, %Y" -->
Today is <!--#echo var="DATE_LOCAL" -->
```

Modification date of the file

```
This document last modified <!--#flastmod file="index.html" -->
```

This element is also subject to `timefmt` format configurations.

Including the results of a CGI program

This is one of the more common uses of SSI - to output the results of a CGI program, such as everybody's favorite, a "hit counter."

```
<!--#include virtual="/cgi-bin/counter.pl" -->
```

Additional examples

Following are some specific examples of things you can do in your HTML documents with SSI.

When was this document modified?

Earlier, we mentioned that you could use SSI to inform the user when the document was most recently modified. However, the actual method for doing that was left somewhat in question. The following code, placed in your HTML document, will put such a time stamp on your page. Of course, you will have to have SSI correctly enabled, as discussed above.

```
<!--#config timefmt="%A %B %d, %Y" -->
This file last modified <!--#flastmod file="ssi.shtml" -->
```

Of course, you will need to replace the `ssi.shtml` with the actual name of the file that you're referring to. This can be inconvenient if you're just looking for a generic piece of code that you can paste into any file, so you probably want to use the `LAST_MODIFIED` variable instead:

```
<!--#config timefmt="%D" -->
This file last modified <!--#echo var="LAST_MODIFIED" -->
```

For more details on the `timefmt` format, go to your favorite search site and look for `strftime`. The syntax is the same.

Including a standard footer

If you are managing any site that is more than a few pages, you may find that making changes to all those pages can be a real pain, particularly if you are trying to maintain some kind of standard look across all those pages.

Using an include file for a header and/or a footer can reduce the burden of these updates. You just have to make one footer file, and then include it into each page with the `include` SSI command. The `include` element can determine what file to include with either the `file` attribute, or the `virtual` attribute. The `file` attribute is a file path, *relative to the current directory*. That means that it cannot be an absolute file path (starting with `/`), nor can it contain `../` as part of that path. The `virtual` attribute is probably more useful, and should specify a URL relative to the document being served. It can start with a `/`, but must be on the same server as the file being served.

```
<!--#include virtual="/footer.html" -->
```

I'll frequently combine the last two things, putting a `LAST_MODIFIED` directive inside a footer file to be included. SSI directives can be contained in the included file, and includes can be nested - that is, the included file can include another file, and so on.

What else can I config?

In addition to being able to `config` the time format, you can also `config` two other things.

Usually, when something goes wrong with your SSI directive, you get the message

```
[an error occurred while processing this directive]
```

If you want to change that message to something else, you can do so with the `errmsg` attribute to the `config` element:

```
<!--#config errmsg="[It appears that you don't know how to use SSI]"
-->
```

Hopefully, end users will never see this message, because you will have resolved all the problems with your SSI directives before your site goes live. (Right?)

And you can `config` the format in which file sizes are returned with the `sizefmt` attribute. You can specify `bytes` for a full count in bytes, or `abbrev` for an abbreviated number in Kb or Mb, as appropriate.

Executing commands

I expect that I'll have an article some time in the coming months about using SSI with small CGI programs. For now, here's something else that you can do with the `exec` element. You can actually have SSI execute a command using the shell (`/bin/sh`, to be precise - or the DOS shell, if you're on Win32). The following, for example, will give you a directory listing.

```
<pre>
<!--#exec cmd="ls" -->
</pre>
```

or, on Windows

```
<pre>
<!--#exec cmd="dir" -->
</pre>
```

You might notice some strange formatting with this directive on Windows, because the output from `dir` contains the string “<dir>” in it, which confuses browsers.

Note that this feature is exceedingly dangerous, as it will execute whatever code happens to be embedded in the `exec` tag. If you have any situation where users can edit content on your web pages, such as with a “guestbook”, for example, make sure that you have this feature disabled. You can allow SSI, but not the `exec` feature, with the `IncludesNOEXEC` argument to the `Options` directive.

Advanced SSI techniques

In addition to spitting out content, Apache SSI gives you the option of setting variables, and using those variables in comparisons and conditionals.

Caveat

Most of the features discussed in this article are only available to you if you are running Apache 1.2 or later. Of course, if you are not running Apache 1.2 or later, you need to upgrade immediately, if not sooner. Go on. Do it now. We’ll wait.

Setting variables

Using the `set` directive, you can set variables for later use. We’ll need this later in the discussion, so we’ll talk about it here. The syntax of this is as follows:

```
<!--#set var="name" value="Rich" -->
```

In addition to merely setting values literally like that, you can use any other variable, including environment variables (p. 60) or the variables discussed above (like `LAST_MODIFIED`, for example) to give values to your variables. You will specify that something is a variable, rather than a literal string, by using the dollar sign (\$) before the name of the variable.

```
<!--#set var="modified" value="$LAST_MODIFIED" -->
```

To put a literal dollar sign into the value of your variable, you need to escape the dollar sign with a backslash.

```
<!--#set var="cost" value="\$100" -->
```

Finally, if you want to put a variable in the midst of a longer string, and there’s a chance that the name of the variable will run up against some other characters, and thus be confused with those characters, you can place the name of the variable in braces, to remove this confusion. (It’s hard to come up with a really good example of this, but hopefully you’ll get the point.)

```
<!--#set var="date" value="{DATE_LOCAL}-{DATE_GMT}" -->
```

Conditional expressions

Now that we have variables, and are able to set and compare their values, we can use them to express conditionals. This lets SSI be a tiny programming language of sorts. `MOD_INCLUDE` provides an `if`, `elif`, `else`, `endif` structure for building conditional statements. This allows you to effectively generate multiple logical pages out of one actual page.

The structure of this conditional construct is:

```
<!--#if expr="test_condition" -->
<!--#elif expr="test_condition" -->
<!--#else -->
<!--#endif -->
```

A *test_condition* can be any sort of logical comparison - either comparing values to one another, or testing the “truth” of a particular value. (A given string is true if it is nonempty.) For a full list of the comparison operators available to you, see the `MOD_INCLUDE` documentation. Here are some examples of how one might use this construct.

In your configuration file, you could put the following line:

```
BrowserMatchNoCase macintosh Mac
BrowserMatchNoCase MSIE InternetExplorer
```

This will set environment variables “Mac” and “InternetExplorer” to true, if the client is running Internet Explorer on a Macintosh.

Then, in your SSI-enabled document, you might do the following:

```
<!--#if expr=" ${Mac} && ${InternetExplorer}" -->
Apologetic text goes here
<!--#else -->
Cool JavaScript code goes here
<!--#endif -->
```

Not that I have anything against IE on Macs - I just struggled for a few hours last week trying to get some JavaScript working on IE on a Mac, when it was working everywhere else. The above was the interim workaround.

Any other variable (either ones that you define, or normal environment variables) can be used in conditional statements. With Apache’s ability to set environment variables with the `SetEnvIf` directives, and other related directives, this functionality can let you do some pretty involved dynamic stuff without ever resorting to CGI.

Conclusion

SSI is certainly not a replacement for CGI, or other technologies used for generating dynamic web pages. But it is a great way to add small amounts of dynamic content to pages, without doing a lot of extra work.

6.5 Apache Tutorial: .htaccess files

.htaccess files provide a way to make configuration changes on a per-directory basis.

.htaccess files

Related Modules	Related Directives
CORE	ACCESSFILENAME
MOD_AUTH	ALLOWOVERRIDE
MOD_CGI	OPTIONS
MOD_INCLUDE	ADDFHANDLER
MOD_MIME	SETHANDLER
	AUTHTYPE
	AUTHNAME
	AUTHUSERFILE
	AUTHGROUPFILE
	REQUIRE

What they are/How to use them

.htaccess files (or "distributed configuration files") provide a way to make configuration changes on a per-directory basis. A file, containing one or more configuration directives, is placed in a particular document directory, and the directives apply to that directory, and all subdirectories thereof.

⇒ Note:

If you want to call your .htaccess file something else, you can change the name of the file using the [ACCESSFILENAME](#) directive. For example, if you would rather call the file .config then you can put the following in your server configuration file:

```
AccessFileName .config
```

In general, .htaccess files use the same syntax as the main configuration files (p. 19) . What you can put in these files is determined by the [ALLOWOVERRIDE](#) directive. This directive specifies, in categories, what directives will be honored if they are found in a .htaccess file. If a directive is permitted in a .htaccess file, the documentation for that directive will contain an Override section, specifying what value must be in [ALLOWOVERRIDE](#) in order for that directive to be permitted.

For example, if you look at the documentation for the [ADDDFAULTCHARSET](#) directive, you will find that it is permitted in .htaccess files. (See the Context line in the directive summary.) The Override (p. 299) line reads FileInfo. Thus, you must have at least AllowOverride FileInfo in order for this directive to be honored in .htaccess files.

Example:

```
Context: (p. 299)          server config, virtual host,
                          directory, .htaccess
Override: (p. 299)       FileInfo
```

If you are unsure whether a particular directive is permitted in a .htaccess file, look at the documentation for that directive, and check the Context line for ".htaccess".

When (not) to use .htaccess files

In general, you should never use .htaccess files unless you don't have access to the main server configuration file. There is, for example, a prevailing misconception that user authentication should always be done in .htaccess files. This is simply not the case. You can put user authentication configurations in the main server configuration, and this is, in fact, the preferred way to do things.

.htaccess files should be used in a case where the content providers need to make configuration changes to the server on a per-directory basis, but do not have root access on the server system. In the event that the server administrator is not willing to make frequent configuration changes, it might be desirable to permit individual users to make these changes in .htaccess files for themselves. This is particularly true, for example, in cases where ISPs are hosting multiple user sites on a single machine, and want their users to be able to alter their configuration.

However, in general, use of .htaccess files should be avoided when possible. Any configuration that you would consider putting in a .htaccess file, can just as effectively be made in a <DIRECTORY> section in your main server configuration file.

There are two main reasons to avoid the use of .htaccess files.

The first of these is performance. When **ALLOWOVERRIDE** is set to allow the use of .htaccess files, Apache will look in every directory for .htaccess files. Thus, permitting .htaccess files causes a performance hit, whether or not you actually even use them! Also, the .htaccess file is loaded every time a document is requested.

Further note that Apache must look for .htaccess files in all higher-level directories, in order to have a full complement of directives that it must apply. (See section on how directives are applied.) Thus, if a file is requested out of a directory /www/htdocs/example, Apache must look for the following files:

```
/.htaccess
/www/.htaccess
/www/htdocs/.htaccess
/www/htdocs/example/.htaccess
```

And so, for each file access out of that directory, there are 4 additional file-system accesses, even if none of those files are present. (Note that this would only be the case if .htaccess files were enabled for /, which is not usually the case.)

The second consideration is one of security. You are permitting users to modify server configuration, which may result in changes over which you have no control. Carefully consider whether you want to give your users this privilege. Note also that giving users less privileges than they need will lead to additional technical support requests. Make sure you clearly tell your users what level of privileges you have given them. Specifying exactly what you have set **ALLOWOVERRIDE** to, and pointing them to the relevant documentation, will save yourself a lot of confusion later.

Note that it is completely equivalent to put a .htaccess file in a directory /www/htdocs/example containing a directive, and to put that same directive in a Directory section <Directory /www/htdocs/example> in your main server configuration:

.htaccess file in /www/htdocs/example:

```
Contents of .htaccess file in /www/htdocs/example
AddType text/example .exm
```

```
Section from your httpd.conf file
<Directory /www/htdocs/example>
    AddType text/example .exm
</Directory>
```

However, putting this configuration in your server configuration file will result in less of a performance hit, as the configuration is loaded once when Apache starts, rather than every time a file is requested.

The use of `.htaccess` files can be disabled completely by setting the `ALLOWOVERRIDE` directive to none:

```
AllowOverride None
```

How directives are applied

The configuration directives found in a `.htaccess` file are applied to the directory in which the `.htaccess` file is found, and to all subdirectories thereof. However, it is important to also remember that there may have been `.htaccess` files in directories higher up. Directives are applied in the order that they are found. Therefore, a `.htaccess` file in a particular directory may override directives found in `.htaccess` files found higher up in the directory tree. And those, in turn, may have overridden directives found yet higher up, or in the main server configuration file itself.

Example:

In the directory `/www/htdocs/example1` we have a `.htaccess` file containing the following:

```
Options +ExecCGI
```

(Note: you must have `"AllowOverride Options"` in effect to permit the use of the `"OPTIONS"` directive in `.htaccess` files.)

In the directory `/www/htdocs/example1/example2` we have a `.htaccess` file containing:

```
Options Includes
```

Because of this second `.htaccess` file, in the directory `/www/htdocs/example1/example2`, CGI execution is not permitted, as only `Options Includes` is in effect, which completely overrides any earlier setting that may have been in place.

Merging of .htaccess with the main configuration files

As discussed in the documentation on Configuration Sections (p. 21), `.htaccess` files can override the `<DIRECTORY>` sections for the corresponding directory, but will be overridden by other types of configuration sections from the main configuration files. This fact can be used to enforce certain configurations, even in the presence of a liberal `ALLOWOVERRIDE` setting. For example, to prevent script execution while allowing anything else to be set in `.htaccess` you can use:

```
<Directory />
  Allowoverride All
</Directory>
<Location />
  Options +IncludesNoExec -ExecCGI
</Location>
```

Authentication example

If you jumped directly to this part of the document to find out how to do authentication, it is important to note one thing. There is a common misconception that you are required to use `.htaccess` files in order to implement password authentication. This is not the case. Putting authentication directives in a `<DIRECTORY>` section, in your main server configuration file, is the preferred way to implement this, and `.htaccess` files should be used only if you don't have access to the main server configuration file. See above for a discussion of when you should and should not use `.htaccess` files.

Having said that, if you still think you need to use a `.htaccess` file, you may find that a configuration such as what follows may work for you.

You must have `"AllowOverride AuthConfig"` in effect for these directives to be honored.

`.htaccess` file contents:

```
AuthType Basic
AuthName "Password Required"
AuthUserFile /www/passwords/password.file
AuthGroupFile /www/passwords/group.file
Require Group admins
```

Note that `AllowOverride AuthConfig` must be in effect for these directives to have any effect.

Please see the authentication tutorial (p. 181) for a more complete discussion of authentication and authorization.

Server Side Includes example

Another common use of `.htaccess` files is to enable Server Side Includes for a particular directory. This may be done with the following configuration directives, placed in a `.htaccess` file in the desired directory:

```
Options +Includes
AddType text/html shtml
AddHandler server-parsed shtml
```

Note that `AllowOverride Options` and `AllowOverride FileInfo` must both be in effect for these directives to have any effect.

Please see the SSI tutorial (p. 191) for a more complete discussion of server-side includes.

CGI example

Finally, you may wish to use a `.htaccess` file to permit the execution of CGI programs in a particular directory. This may be implemented with the following configuration:

```
Options +ExecCGI
AddHandler cgi-script cgi pl
```

Alternately, if you wish to have all files in the given directory be considered to be CGI programs, this may be done with the following configuration:

```
Options +ExecCGI
SetHandler cgi-script
```

Note that `AllowOverride Options` and `AllowOverride FileInfo` must both be in effect for these directives to have any effect.

Please see the CGI tutorial (p. 185) for a more complete discussion of CGI programming and configuration.

Troubleshooting

When you put configuration directives in a `.htaccess` file, and you don't get the desired effect, there are a number of things that may be going wrong.

Most commonly, the problem is that `ALLOWOVERRIDE` is not set such that your configuration directives are being honored. Make sure that you don't have a `AllowOverride None` in effect for the file scope in question. A good test for this is to put garbage in your `.htaccess` file and reload. If a server error is not generated, then you almost certainly have `AllowOverride None` in effect.

If, on the other hand, you are getting server errors when trying to access documents, check your Apache error log. It will likely tell you that the directive used in your `.htaccess` file is not permitted. Alternately, it may tell you that you had a syntax error, which you will then need to fix.

6.6 Per-user web directories

On systems with multiple users, each user can be permitted to have a web site in their home directory using the [USERDIR](#) directive. Visitors to a URL `http://example.com/~username/` will get content out of the home directory of the user "username", out of the subdirectory specified by the [USERDIR](#) directive.

See also

- Mapping URLs to the Filesystem (p. 36)

Per-user web directories

Related Modules	Related Directives
MOD_USERDIR	USERDIR DIRECTORYMATCH ALLOWOVERRIDE

Setting the file path with UserDir

The [USERDIR](#) directive specifies a directory out of which per-user content is loaded. This directive may take several different forms.

If a path is given which does not start with a leading slash, it is assumed to be a directory path relative to the home directory of the specified user. Given this configuration:

```
UserDir public_html
```

the URL `http://example.com/~rbowen/file.html` will be translated to the file path `/home/rbowen/public_html/file.html`

If a path is given starting with a slash, a directory path will be constructed using that path, plus the username specified. Given this configuration:

```
UserDir /var/html
```

the URL `http://example.com/~rbowen/file.html` will be translated to the file path `/var/html/rbowen/file.html`

If a path is provided which contains an asterisk (*), a path is used in which the asterisk is replaced with the username. Given this configuration:

```
UserDir /var/www/*/docs
```

the URL `http://example.com/~rbowen/file.html` will be translated to the file path `/var/www/rbowen/docs/file.html`

Restricting what users are permitted to use this feature

Using the syntax shown in the UserDir documentation, you can restrict what users are permitted to use this functionality:

```
UserDir enabled
UserDir disabled root jro fish
```

The configuration above will enable the feature for all users except for those listed in the `disabled` statement. You can, likewise, disable the feature for all but a few users by using a configuration like the following:

```
UserDir disabled
UserDir enabled rbowen krietz
```

See [USERDIR](#) documentation for additional examples.

Enabling a cgi directory for each user

In order to give each user their own cgi-bin directory, you can use a `<DIRECTORY>` directive to make a particular subdirectory of a user's home directory cgi-enabled.

```
<Directory /home/*/public_html/cgi-bin/>
Options ExecCGI
SetHandler cgi-script
</Directory>
```

Then, presuming that UserDir is set to `public_html`, a cgi program `example.cgi` could be loaded from that directory as:

```
http://example.com/~rbowen/cgi-bin/example.cgi
```

Allowing users to alter configuration

If you want to allow users to modify the server configuration in their web space, they will need to use `.htaccess` files to make these changes. Ensure that you have set `ALLOWOVERWRITE` to a value sufficient for the directives that you want to permit the users to modify. See the `.htaccess` tutorial (p. 197) for additional details on how this works.

6.7 Apache Tutorials



Warning:

This document has not been fully updated to take into account changes made in the 2.0 version of the Apache HTTP Server. Some of the information may still be relevant, but please use it with care.

The following documents give you step-by-step instructions on how to accomplish common tasks with the Apache HTTP server. Many of these documents are located at external sites and are not the work of the Apache Software Foundation. Copyright to documents on external sites is owned by the authors or their assignees. Please consult the official Apache Server documentation (p. ??) to verify what you read on external sites.

Installation & Getting Started

- Getting Started with Apache 1.3⁶ (ApacheToday)
- Configuring Your Apache Server Installation⁷ (ApacheToday)
- Getting, Installing, and Running Apache (on Unix)⁸ (O'Reilly Network Apache DevCenter)
- Maximum Apache: Getting Started⁹ (CNET Builder.com)
- How to Build the Apache of Your Dreams¹⁰ (Developer Shed)

Basic Configuration

- An Amble Through Apache Configuration¹¹ (O'Reilly Network Apache DevCenter)
- Using .htaccess Files with Apache¹² (ApacheToday)
- Setting Up Virtual Hosts¹³ (ApacheToday)
- Maximum Apache: Configure Apache¹⁴ (CNET Builder.com)
- Getting More Out of Apache¹⁵ (Developer Shed)

Security

- Security and Apache: An Essential Primer¹⁶ (LinuxPlanet)
- Using User Authentication¹⁷ (Apacheweek)
- DBM User Authentication¹⁸ (Apacheweek)
- An Introduction to Securing Apache¹⁹ (Linux.com)
- Securing Apache - Access Control²⁰ (Linux.com)

⁶http://apachetoday.com/news_story.php3?itsn=2000-06-1-001-01-NW-DP-LF

⁷http://apachetoday.com/news_story.php3?itsn=2000-07-10-001-01-NW-LF-SW

⁸http://www.onlamp.com/pub/a/apache/2000/02/24/installing_apache.html

⁹<http://www.builder.com/Servers/Apache/ss01.html>

¹⁰http://www.devshed.com/Server_Side/Administration/APACHE/

¹¹http://www.onlamp.com/pub/a/apache/2000/03/02/configuring_apache.html

¹²http://apachetoday.com/news_story.php3?itsn=2000-07-19-002-01-NW-LF-SW

¹³http://apachetoday.com/news_story.php3?itsn=2000-07-17-001-01-PS

¹⁴<http://www.builder.com/Servers/Apache/ss02.html>

¹⁵http://www.devshed.com/Server_Side/Administration/MoreApache/

¹⁶<http://www.linuxplanet.com/linuxplanet/tutorials/1527/1/>

¹⁷<http://www.apacheweek.com/features/userauth>

¹⁸<http://www.apacheweek.com/features/dbmauth>

¹⁹<http://linux.com/security/newsitem.phtml?sid=12&aid=3549>

²⁰<http://linux.com/security/newsitem.phtml?sid=12&aid=3667>

- Apache Authentication Part 1²¹ - Part 2²² - Part 3²³ - Part 4²⁴ (ApacheToday)
- mod_access: Restricting Access by Host²⁵ (ApacheToday)

Logging

- Log Rhythms²⁶ (O'Reilly Network Apache DevCenter)
- Gathering Visitor Information: Customising Your Logfiles²⁷ (Apacheweek)
- Apache Guide: Logging Part 1²⁸ - Part 2²⁹ - Part 3³⁰ - Part 4³¹ - Part 5³² (ApacheToday)

CGI and SSI

- Dynamic Content with CGI³³ (ApacheToday)
- The Idiot's Guide to Solving Perl CGI Problems³⁴ (CPAN)
- Executing CGI Scripts as Other Users³⁵ (LinuxPlanet)
- CGI Programming FAQ³⁶ (Web Design Group)
- Introduction to Server Side Includes Part 1³⁷ - Part 2³⁸ (ApacheToday)
- Advanced SSI Techniques³⁹ (ApacheToday)
- Setting up CGI and SSI with Apache⁴⁰ (CNET Builder.com)

Other Features

- Content Negotiation Explained⁴¹ (Apacheweek)
- Using Apache Imagemaps⁴² (Apacheweek)
- Keeping Your Images from Adorning Other Sites⁴³ (ApacheToday)
- Language Negotiation Notes⁴⁴ (Alan J. Flavell)

²¹http://apachetoday.com/news_story.php3?itsn=2000-07-24-002-01-NW-LF-SW

²²http://apachetoday.com/news_story.php3?itsn=2000-07-31-001-01-NW-DP-LF

²³http://apachetoday.com/news_story.php3?itsn=2000-08-07-001-01-NW-LF-SW

²⁴http://apachetoday.com/news_story.php3?itsn=2000-08-14-001-01-NW-LF-SW

²⁵http://apachetoday.com/news_story.php3?itsn=2000-11-13-003-01-SC-LF-SW

²⁶http://www.onlamp.com/pub/a/apache/2000/03/10/log_rhythms.html

²⁷<http://www.apacheweek.com/features/logfiles>

²⁸http://apachetoday.com/news_story.php3?itsn=2000-08-21-003-01-NW-LF-SW

²⁹http://apachetoday.com/news_story.php3?itsn=2000-08-28-001-01-NW-LF-SW

³⁰http://apachetoday.com/news_story.php3?itsn=2000-09-05-001-01-NW-LF-SW

³¹http://apachetoday.com/news_story.php3?itsn=2000-09-18-003-01-NW-LF-SW

³²http://apachetoday.com/news_story.php3?itsn=2000-09-25-001-01-NW-LF-SW

³³http://apachetoday.com/news_story.php3?itsn=2000-06-05-001-10-NW-LF-SW

³⁴<http://www.cpan.org/doc/FAQs/cgi/idiots-guide.html>

³⁵<http://www.linuxplanet.com/linuxplanet/tutorials/1445/1/>

³⁶<http://www.htmlhelp.org/faq/cgifaq.html>

³⁷http://apachetoday.com/news_story.php3?itsn=2000-06-12-001-01-PS

³⁸http://apachetoday.com/news_story.php3?itsn=2000-06-19-002-01-NW-LF-SW

³⁹http://apachetoday.com/news_story.php3?itsn=2000-06-26-001-01-NW-LF-SW

⁴⁰<http://www.builder.com/Servers/ApacheFiles/082400/>

⁴¹<http://www.apacheweek.com/features/negotiation>

⁴²<http://www.apacheweek.com/features/imagemaps>

⁴³http://apachetoday.com/news_story.php3?itsn=2000-06-14-002-01-PS

⁴⁴<http://ppewwww.ph.gla.ac.uk/~flavell/www/lang-neg.html>

If you have a pointer to an accurate and well-written tutorial not included here, please let us know by submitting it to the Apache Bug Database⁴⁵.

⁴⁵<http://bugs.apache.org/>

Chapter 7

Platform-specific Notes

7.1 Platform Specific Notes

Microsoft Windows

Using Apache This document explains how to install, configure and run Apache 2.0 under Microsoft Windows.

See: Using Apache with Microsoft Windows (p. [209](#))

Compiling Apache There are many important points before you begin compiling Apache. This document explain them.

See: Compiling Apache for Microsoft Windows (p. [218](#))

Other Platforms

Novell NetWare This document explains how to install, configure and run Apache 2.0 under Novell NetWare 5.1 and above.

See: Using Apache With Novell NetWare (p. [223](#))

EBCDIC Version 1.3 of the Apache HTTP Server is the first version which includes a port to a (non-ASCII) main-frame machine which uses the EBCDIC character set as its native codeset.



Warning: This document has not been updated to take into account changes made in the 2.0 version of the Apache HTTP Server. Some of the information may still be relevant, but please use it with care.

See: The Apache EBCDIC Port (p. [230](#))

7.2 Using Apache with Microsoft Windows

This document explains how to install, configure and run Apache 2.0 under Microsoft Windows. If you find any bugs, or wish to contribute in other ways, please use our bug reporting page¹.

This document assumes that you are installing a binary distribution of Apache. If you want to compile Apache yourself (possibly to help with development or tracking down bugs), see Compiling Apache for Microsoft Windows (p. 218).

Because of the current versioning policies on Microsoft Windows operating system families, this document assumes the following:

- **Windows NT:** This means all versions of Windows that are based on the Windows NT kernel. Includes Windows NT, Windows 2000, Windows XP and Windows .Net Server 2003.
- **Windows 9x:** This means older, consumer-oriented versions of Windows. Includes Windows 95 (also OSR2), Windows 98 and Windows ME.

Operating System Requirements

The primary Windows platform for running Apache 2.0 is Windows NT. The binary installer only works with the x86 family of processors, such as Intel and AMD processors. Running Apache on Windows 9x is not thoroughly tested, and it is never recommended on production systems.

On all operating systems, TCP/IP networking must be installed and working. If running on Windows 95, the Winsock 2 upgrade must be installed. Winsock 2 for Windows 95 can be downloaded from here².

On Windows NT 4.0, installing Service Pack 6 is strongly recommended, as Service Pack 4 created known issues with TCP/IP and Winsock integrity that were resolved in later Service Packs.

Downloading Apache for Windows

Information on the latest versions of Apache can be found on the web site of the Apache web server at <http://httpd.apache.org/download.cgi>. There you will find the current release, as well as more recent alpha or beta test versions, and a list of HTTP and FTP mirrors from which you can download the Apache web server. Please use a mirror near to you for a fast and reliable download.

For Windows installations you should download the version of Apache for Windows with the `.msi` extension. This is a single Microsoft Installer file, which contains a ready-to-run version of Apache. There is a separate `.zip` file, which contains only the source code. You can compile Apache yourself with the Microsoft Visual C++ (Visual Studio) tools.

Installing Apache for Windows

You need Microsoft Installer 1.2 or above for the installation to work. On Windows 9x you can update your Microsoft Installer to version 2.0 here³ and on Windows NT 4.0 and 2000 the version 2.0 update can be found here⁴. Windows XP does not need this update.

Note that you cannot install two versions of Apache 2.0 on the same computer with the binary installer. You can, however, install a version of the 1.3 series **and** a version of the 2.0 series on the same computer without problems. If you need to have two different 2.0 versions on the same computer, you have to compile and install Apache from the source (p. 218).

Run the Apache `.msi` file you downloaded above. The installation will ask you for these things:

¹http://httpd.apache.org/bug_report.html

²http://www.microsoft.com/windows95/downloads/contents/WUAdminTools/S_WUNetworkingTools/W95Sockets2/Default.asp

³<http://www.microsoft.com/downloads/release.asp?ReleaseID=32831>

⁴<http://www.microsoft.com/downloads/release.asp?ReleaseID=32832>

1. **Network Domain.** Enter the DNS domain in which your server is or will be registered in. For example, if your server's full DNS name is `server.mydomain.net`, you would type `mydomain.net` here.
2. **Server Name.** Your server's full DNS name. From the example above, you would type `server.mydomain.net` here.
3. **Administrator's Email Address.** Enter the server administrator's or webmaster's email address here. This address will be displayed along with error messages to the client by default.
4. **For whom to install Apache** Select `for All Users`, on Port `80`, as a `Service - Recommended` if you'd like your new Apache to listen at port 80 for incoming traffic. It will run as a service (that is, Apache will run even if no one is logged in on the server at the moment) Select `only for the Current User`, on Port `8080`, when started `Manually` if you'd like to install Apache for your personal experimenting or if you already have another WWW server running on port 80.
5. **The installation type.** Select `Typical` for everything except the source code and libraries for module development. With `Custom` you can specify what to install. A full install will require about 13 megabytes of free disk space. This does *not* include the size of your web site(s).
6. **Where to install.** The default path is `C:\Program Files\Apache Group` under which a directory called `Apache2` will be created by default.

During the installation, Apache will configure the files in the `conf` subdirectory to reflect the chosen installation directory. However, if any of the configuration files in this directory already exist, they will not be overwritten. Instead, the new copy of the corresponding file will be left with the extension `.default`. So, for example, if `conf\httpd.conf` already exists, it will be renamed as `conf\httpd.conf.default`. After the installation you should manually check to see what new settings are in the `.default` file, and if necessary, update your existing configuration file.

Also, if you already have a file called `htdocs\index.html`, it will not be overwritten (and no `index.html.default` will be installed either). This means it should be safe to install Apache over an existing installation, although you would have to stop the existing running server before doing the installation, and then start the new one after the installation is finished.

After installing Apache, you must edit the configuration files in the `conf` subdirectory as required. These files will be configured during the installation so that Apache is ready to be run from the directory it was installed into, with the documents server from the subdirectory `htdocs`. There are lots of other options which you should set before you really start using Apache. However, to get started quickly, the files should work as installed.

Customizing Apache for Windows

Apache is configured by the files in the `conf` subdirectory. These are the same files used to configure the Unix version, but there are a few different directives for Apache on Windows. See the directive index (p. 663) for all the available directives.

The main differences in Apache for Windows are:

- Because Apache for Windows is multithreaded, it does not use a separate process for each request, as Apache does on Unix. Instead there are usually only two Apache processes running: a parent process, and a child which handles the requests. Within the child process each request is handled by a separate thread.

The process management directives are also different:

MAXREQUESTSPERCHILD: Like the Unix directive, this controls how many requests a single child process will serve before exiting. However, unlike on Unix, a single process serves all the requests at once, not just one. If this is set, it is recommended that a very high number is used. The recommended default, `MaxRequestsPerChild 0`, causes the child process to never exit.



Warning: The server configuration file is reread when a new child process is started. If you have modified `httpd.conf`, the new child may not start or you may receive unexpected results.

THREADSPERCHILD: This directive is new. It tells the server how many threads it should use. This is the maximum number of connections the server can handle at once, so be sure to set this number high enough for your site if you get a lot of hits. The recommended default is `ThreadsPerChild 50`.

- The directives that accept filenames as arguments must use Windows filenames instead of Unix ones. However, because Apache uses Unix-style names internally, you must use forward slashes, not backslashes. Drive letters can be used; if omitted, the drive with the Apache executable will be assumed.
- While filenames are generally case-insensitive on Windows, URLs are still treated internally as case-sensitive before they are mapped to the filesystem. For example, the `<LOCATION>`, `ALIAS`, and `PROXYPASS` directives all use case-sensitive arguments. For this reason, it is particularly important to use the `<DIRECTORY>` directive when attempting to limit access to content in the filesystem, since this directive applies to any content in a directory, regardless of how it is accessed. If you wish to assure that only lowercase is used in URLs, you can use something like:

```
RewriteEngine On
RewriteMap lowercase int:tolower
RewriteCond %{REQUEST_URI} [A-Z]
RewriteRule (.*) ${lowercase:$1} [R,L]
```

- Apache for Windows contains the ability to load modules at runtime, without recompiling the server. If Apache is compiled normally, it will install a number of optional modules in the `\Apache2\modules` directory. To activate these or other modules, the new `LOADMODULE` directive must be used. For example, to activate the status module, use the following (in addition to the status-activating directives in `access.conf`):

```
LoadModule status_module modules/mod_status.so
```

Information on creating loadable modules (p. 545) is also available.

- Apache can also load ISAPI (Internet Server Application Programming Interface) extensions (i.e. internet server applications), such as those used by Microsoft IIS and other Windows servers. More information is available (p. 461). Note that Apache **cannot** load ISAPI Filters.
- When running CGI scripts, the method Apache uses to find the interpreter for the script is configurable using the `SCRIPTINTERPRETERSOURCE` directive.
- Since it is often difficult to manage files with names like `.htaccess` in Windows, you may find it useful to change the name of this per-directory configuration file using the `ACCESSFILENAME` directive.
- Any errors during Apache startup are logged into the Windows event log when running on Windows NT. This mechanism acts as a backup for those situations where Apache cannot even access the normally used `error.log` file. You can view the Windows event log by using the Event Viewer application on Windows NT 4.0, and the Event Viewer MMC snap-in on newer versions of Windows.

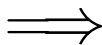

Note that there is no startup error logging on Windows 9x because no Windows event log exists on those operating systems.

Running Apache as a Service

Apache can be run as a service on Windows NT. There is some highly experimental support for similar behavior on Windows 9x.

You can install Apache as a service automatically during the installation. If you chose to install for all users, the installation will create an Apache service for you. If you specify to install for yourself only, you can manually register Apache as a service after the installation. You have to be a member of the Administrators group for the service installation to succeed.

Apache comes with a utility called the Apache Service Monitor. With it you can see and manage the state of all installed Apache services on any machine on your network. To be able to manage an Apache service with the monitor, you have to first install the service (either automatically via the installation or manually).

You can install Apache as a Windows NT service as follows from the command prompt at the Apache `bin` subdirectory:

```
httpd -k install
```

If you need to specify the name of the service you want to install, use the following command. You have to do this if you have several different service installations of Apache on your computer.

```
httpd -k install -n "MyServiceName"
```

If you need to have specifically named configuration files for different services, you must use this:

```
httpd -k install -n "MyServiceName" -f "c:\files\my.conf"
```

If you use the first command without any special parameters except `-k install`, the service will be called `Apache2` and the configuration will be assumed to be `conf\httpd.conf`.

Removing an Apache service is easy. Just use:

```
httpd -k uninstall
```

The specific Apache service to be uninstalled can be specified by using:

```
httpd -k uninstall -n "MyServiceName"
```

Normal starting, restarting and shutting down of an Apache service is usually done via the Apache Service Monitor, by using commands like `NET START Apache2` and `NET STOP Apache2` or via normal Windows service management. Before starting Apache as a service by any means, you should test the service's configuration file by using:

```
httpd -n "MyServiceName" -t
```

You can control an Apache service by its command line switches, too. To start an installed Apache service you'll use this:

```
httpd -k start
```

To stop an Apache service via the command line switches, use this:

```
httpd -k stop
```

or

```
httpd -k shutdown
```

You can also restart a running service and force it to reread its configuration file by using:

```
httpd -k restart
```

By default, all Apache services are registered to run as the system user (the `LocalSystem` account). The `LocalSystem` account has no privileges to your network via any Windows-secured mechanism, including the file system, named pipes, DCOM, or secure RPC. It has, however, wide privileges locally.



Never grant any network privileges to the `LocalSystem` account! If you need Apache to be able to access network resources, create a separate account for Apache as noted below.

You may want to create a separate account for running Apache service(s). Especially, if you have to access network resources via Apache, this is strongly recommended.

1. Create a normal domain user account, and be sure to memorize its password.
2. Grant the newly-created user a privilege of Log on as a service and Act as part of the operating system. On Windows NT 4.0 these privileges are granted via User Manager for Domains, but on Windows 2000 and XP you probably want to use Group Policy for propagating these settings. You can also manually set these via the Local Security Policy MMC snap-in.
3. Confirm that the created account is a member of the Users group.
4. Grant the account read and execute (RX) rights to all document and script folders (`htdocs` and `cgi-bin` for example).
5. Grant the account change (RWXD) rights to the Apache `logs` directory.
6. Grant the account read and execute (RX) rights to the Apache `.exe` binary executable.

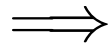

It is usually a good practice to grant the user the Apache service runs as read and execute (RX) access to the whole `Apache2` directory, except the `logs` subdirectory, where the user has to have at least change (RWXD) rights.

If you allow the account to log in as a user and as a service, then you can log on with that account and test that the account has the privileges to execute the scripts, read the web pages, and that you can start Apache in a console window. If this works, and you have followed the steps above, Apache should execute as a service with no problems.

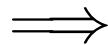

Error code 2186 is a good indication that you need to review the "Log On As" configuration for the service, since Apache cannot access a required network resource. Also, pay close attention to the privileges of the user Apache is configured to run as.

When starting Apache as a service you may encounter an error message from the Windows Service Control Manager. For example, if you try to start Apache by using the Services applet in the Windows Control Panel, you may get the following message:

```
Could not start the Apache2 service on \\COMPUTER
Error 1067; The process terminated unexpectedly.
```

You will get this generic error if there is any problem with starting the Apache service. In order to see what is really causing the problem you should follow the instructions for Running Apache for Windows from the Command Prompt.

There is some support for Apache on Windows 9x to behave in a similar manner as a service on Windows NT. It is **highly experimental**. It is not of production-class reliability, and its future is not guaranteed. It can be mostly regarded as a risky thing to play with - proceed with caution!

There are some differences between the two kinds of services you should be aware of:

- Apache will attempt to start and if successful it will run in the background. If you run the command

```
httpd -n "MyServiceName" -k start
```

via a shortcut on your desktop, for example, then if the service starts successfully, a console window will flash up but it immediately disappears. If Apache detects any errors on startup such as incorrect entries in the httpd.conf configuration file, the console window will remain visible. This will display an error message which will be useful in tracking down the cause of the problem.

- Windows 9x does not support NET START or NET STOP commands. You must control the Apache service on the command prompt via the `-k` switches.
- Apache and Windows 9x offer no support for running Apache as a specific user with network privileges. In fact, Windows 9x offers no security on the local machine, either. This is the simple reason because of which the Apache Software Foundation never endorses use of a Windows 9x -based system as a public Apache server. The primitive support for Windows 9x exists only to assist the user in developing web content and learning the Apache server, and perhaps as an intranet server on a secured, private network.

Once you have confirmed that Apache runs correctly as a console application you can install, control and uninstall the pseudo-service with the same commands as on Windows NT. You can also use the Apache Service Monitor to manage Windows 9x pseudo-services.

Running Apache as a Console Application

Running Apache as a service is usually the recommended way to use it, but it is sometimes easier to work from the command line (on Windows 9x running Apache from the command line is the recommended way due to the lack of reliable service support.)

To run Apache from the command line as a console application, use the following command:

```
httpd
```

Apache will execute, and will remain running until it is stopped by pressing Control-C.

You can also run Apache via the shortcut Start Apache in Console placed to Start Menu --> Programs --> Apache HTTP Server 2.0.xx --> Control Apache Server during the installation. This will open a console window and start Apache inside it. If you don't have Apache installed as a service, the window will remain visible until you stop Apache by pressing Control-C in the console window where Apache is running in. The server will exit in a few seconds. However, if you do have Apache installed as a service, the shortcut starts the service. If the Apache service is running already, the shortcut doesn't do anything.

You can tell a running Apache to stop by opening another console window and entering:

```
httpd -k shutdown
```

This should be preferred over pressing Control-C because this lets Apache end any current operations and clean up gracefully.

You can also tell Apache to restart. This forces it to reread the configuration file. Any operations in progress are allowed to complete without interruption. To restart Apache, use:

```
httpd -k restart
```

⇒ Note for people familiar with the Unix version of Apache: these commands provide a Windows equivalent to `kill -TERM pid` and `kill -USR1 pid`. The command line option used, `-k`, was chosen as a reminder of the `kill` command used on Unix.

If the Apache console window closes immediately or unexpectedly after startup, open the Command Prompt from the Start Menu → Programs. Change to the folder to which you installed Apache, type the command `apache`, and read the error message. Then change to the logs folder, and review the `error.log` file for configuration mistakes. If you accepted the defaults when you installed Apache, the commands would be:

```
c:
cd "\Program Files\Apache Group\Apache2\bin"
httpd
```

Then wait for Apache to stop, or press Control-C. Then enter the following:

```
cd ..\logs
more < error.log
```

When working with Apache it is important to know how it will find the configuration file. You can specify a configuration file on the command line in two ways:

- `-f` specifies an absolute or relative path to a particular configuration file:

```
httpd -f "c:\my server files\anotherconfig.conf"
```

or

```
httpd -f files\anotherconfig.conf
```

- `-n` specifies the installed Apache service whose configuration file is to be used:

```
httpd -n "MyServiceName"
```

In both of these cases, the proper `SERVERROOT` should be set in the configuration file.

If you don't specify a configuration file with `-f` or `-n`, Apache will use the file name compiled into the server, such as `conf\httpd.conf`. This built-in path is relative to the installation directory. You can verify the compiled file name from a value labelled as `SERVER_CONFIG_FILE` when invoking Apache with the `-V` switch, like this:

```
httpd -V
```

Apache will then try to determine its `SERVERROOT` by trying the following, in this order:

1. A `SERVERROOT` directive via the `-C` command line switch.
2. The `-d` switch on the command line.
3. Current working directory.
4. A registry entry which was created if you did a binary installation.
5. The server root compiled into the server. This is `/apache` by default, you can verify it by using `apache -V` and looking for a value labelled as `HTTPD_ROOT`.

During the installation, a version-specific registry key is created in the Windows registry. The location of this key depends on the type of the installation. If you chose to install Apache for all users, the key is located under the `HKEY_LOCAL_MACHINE` hive, like this (the version numbers will of course vary between different versions of Apache:

```
HKEY_LOCAL_MACHINE\SOFTWARE\Apache Group\Apache\2.0.43
```

Correspondingly, if you chose to install Apache for the current user only, the key is located under the `HKEY_CURRENT_USER` hive, the contents of which are dependent of the user currently logged on:

```
HKEY_CURRENT_USER\SOFTWARE\Apache Group\Apache\2.0.43
```

This key is compiled into the server and can enable you to test new versions without affecting the current version. Of course, you must take care not to install the new version in the same directory as another version.

If you did not do a binary install, Apache will in some scenarios complain about the missing registry key. This warning can be ignored if the server was otherwise able to find its configuration file.

The value of this key is the `SERVERROOT` directory which contains the `conf` subdirectory. When Apache starts it reads the `httpd.conf` file from that directory. If this file contains a `SERVERROOT` directive which contains a different directory from the one obtained from the registry key above, Apache will forget the registry key and use the directory from the configuration file. If you copy the Apache directory or configuration files to a new location it is vital that you update the `SERVERROOT` directive in the `httpd.conf` file to reflect the new location.

Testing the Installation

After starting Apache (either in a console window or as a service) it will be listening on port 80 (unless you changed the `LISTEN` directive in the configuration files or installed Apache only for the current user). To connect to the server and access the default page, launch a browser and enter this URL:

```
http://localhost/
```

Apache should respond with a welcome page and a link to the Apache manual. If nothing happens or you get an error, look in the `error.log` file in the `logs` subdirectory. If your host is not connected to the net, or if you have serious problems with your DNS (Domain Name Service) configuration, you may have to use this URL:

```
http://127.0.0.1/
```

If you happen to be running Apache on an alternate port, you need to explicitly put that in the URL:

```
http://127.0.0.1:8080/
```

Once your basic installation is working, you should configure it properly by editing the files in the `conf` subdirectory. Again, if you change the configuration of the Windows NT service for Apache, first attempt to start it from the command line to make sure that the service starts with no errors.

Because Apache **cannot** share the same port with another TCP/IP application, you may need to stop, uninstall or reconfigure certain other services before running Apache. These conflicting services include other WWW servers and some firewall implementations.

7.3 Compiling Apache for Microsoft Windows

There are many important points before you begin compiling Apache. See [Using Apache with Microsoft Windows \(p. 209\)](#) before you begin.

Requirements

Compiling Apache requires the following environment to be properly installed:

- Disk Space

Make sure you have at least 50 MB of free disk space available. After installation Apache requires approximately 10 MB of disk space, plus space for log and cache files, which can grow rapidly. The actual disk space requirements will vary considerably based on your chosen configuration and any third-party modules or libraries.

- Microsoft Visual C++ 5.0 or higher.

Apache can be built using the command line tools, or from within the Visual Studio IDE Workbench. The command line build requires the environment to reflect the `PATH`, `INCLUDE`, `LIB` and other variables that can be configured with the `vcvars32` batch file:

```
"c:\Program Files\DevStudio\VC\Bin\vcvars32.bat"
```

- The Windows Platform SDK.

Visual C++ 5.0 builds require an updated Microsoft Windows Platform SDK to enable some Apache features. For command line builds, the Platform SDK environment is prepared by the `setenv` batch file:

```
"c:\Program Files\Platform SDK\setenv.bat"
```

The Platform SDK files distributed with Visual C++ 6.0 and later are sufficient, so users of later version may skip this requirement.

⇒ Note that the Windows Platform SDK update is required to enable all supported `MOD_ISAPI` features. Without a recent update, Apache will issue warnings under `MSVC++ 5.0` that some `MOD_ISAPI` features will be disabled. Look for the update at <http://msdn.microsoft.com/downloads/sdks/platform/platform.asp>.

- The awk utility (awk, gawk or similar).

To install Apache within the build system, several files are modified using the `awk.exe` utility. `awk` was chosen since it is a very small download (compared with Perl or WSH/VB) and accomplishes the task of generating files. Brian Kernighan's <http://cm.bell-labs.com/cm/cs/who/bwk/> site has a compiled native Win32 binary, <http://cm.bell-labs.com/cm/cs/who/bwk/awk95.exe> which you must save with the name `awk.exe` rather than `awk95.exe`.

⇒ Note that Developer Studio IDE will only find `awk.exe` from the Tools menu Options... Directories tab (the Projects - VC++ Directories pane in Developer Studio 7.0) listing Executable file paths. Add the path for `awk.exe` to this list, and your system `PATH` environment variable, as needed.

⇒ Also note that if you are using Cygwin (<http://www.cygwin.com/>) the `awk` utility is named `gawk.exe` and that the file `awk.exe` is really a symlink to the `gawk.exe` file. The Windows command shell does not recognize symlinks, and because of that building `InstallBin` will fail. A workaround is to delete `awk.exe` from the cygwin installation and rename `gawk.exe` to `awk.exe`.

- [Optional] OpenSSL libraries (for [MOD_SSL](#) and `ab.exe` with ssl support)

Caution: there are significant restrictions and prohibitions on the use and distribution of strong cryptography and patented intellectual property throughout the world. OpenSSL includes strong cryptography controlled by both export regulations and domestic law, as well as intellectual property protected by patent, in the United States and elsewhere. Neither the Apache Software Foundation nor the OpenSSL project can provide legal advice regarding possession, use, or distribution of the code provided by the OpenSSL project. **Consult your own legal counsel, you are responsible for your own actions.**

OpenSSL must be installed into a `srclib` subdirectory named `openssl`, obtained from <http://www.openssl.org/source/>, in order to compile [MOD_SSL](#) or the `abs` project (`ab.exe` with SSL support.) To prepare OpenSSL for both `release` and `debug` builds of Apache, and disable the patent protected features in OpenSSL, you might use the following build commands:

```
perl Configure VC-WIN32
perl util\mkfiles.pl >MINFO
perl util\mk1mf.pl dll no-asm no-mdc2 no-rc5 no-idea VC-WIN32
>makefile.rel
perl util\mk1mf.pl dll debug no-asm no-mdc2 no-rc5 no-idea VC-WIN32
>makefile.dbg
perl util\mkdef.pl 32 libeay no-asm no-mdc2 no-rc5 no-idea
>ms\libeay32.def
perl util\mkdef.pl 32 ssleay no-asm no-mdc2 no-rc5 no-idea
>ms\ssleay32.def
nmake -f makefile.rel
nmake -f makefile.dbg
```

Note; you can use the scripts in the `ms\` subdirectory, however, it's rather tricky to force `ms\do_masm.bat`, for example, to perform the patent encumbrances as mentioned above. Patches to add the `$*` argument list to the appropriate `.bat` lines in these scripts aren't incorporated, thus far.

- [Optional] zlib sources (for [MOD_DEFLATE](#))

Zlib must be installed into a `srclib` subdirectory named `zlib`, however those sources need not be compiled. The build system will compile the compression sources directly into the [MOD_DEFLATE](#) module. Zlib can be obtained from <http://www.zlib.net/> – [MOD_DEFLATE](#) is confirmed to build correctly with version 1.1.4. To use a later version of zlib, upgrade to Apache HTTP Server release 2.2 or later.

Command-Line Build

First, unpack the Apache distribution into an appropriate directory. Open a command-line prompt and `cd` to that directory.

The master Apache makefile instructions are contained in the `Makefile.win` file. To compile Apache on Windows NT, simply use one of the following commands to compile the `release` or `debug` build, respectively:

```
nmake /f Makefile.win _apacher
nmake /f Makefile.win _apached
```

Either command will compile Apache. The latter will include debugging information in the resulting files, making it easier to find bugs and track down problems.

Developer Studio Workspace IDE Build

Apache can also be compiled using VC++'s Visual Studio development environment. To simplify this process, a Visual Studio workspace, `Apache.dsw`, is provided. This workspace exposes the entire list of working `.dsp` projects that are required for the complete Apache binary release. It includes dependencies between the projects to assure that they are built in the appropriate order.

Open the `Apache.dsw` workspace, and select `InstallBin` (Release or Debug build, as desired) as the Active Project. `InstallBin` causes all related project to be built, and then invokes `Makefile.win` to move the compiled executables and dlls. You may personalize the `INSTDIR=` choice by changing `InstallBin`'s Settings, General tab, Build command line entry. `INSTDIR` defaults to the `/Apache2` directory. If you only want a test compile (without installing) you may build the `BuildBin` project instead.

The `.dsp` project files are distributed in Visual C++ 6.0 format. Visual C++ 5.0 (97) will recognize them. Visual C++ 7.0 (.net) must convert `Apache.dsw` plus the `.dsp` files into an `Apache.sln` plus `.msproj` files, be sure you reconvert the `.msproj` file if any of the source `.dsp` files change! This is really trivial, just open `Apache.dsw` in the VC++ 7.0 IDE once again.

Visual C++ 7.0 (.net) users should also use the Build menu, Configuration Manager dialog to uncheck both the Debug and Release Solution modules `abs`, `MOD_SSL` and `MOD_DEFLATE`. These modules are built by invoking `nmake` or the IDE directly with the `BinBuild` target to build those modules explicitly, only if the `srclib` directories `openssl` and/or `zlib` exist.

Exported `.mak` files pose a greater hassle, but they are required for Visual C++ 5.0 users to build `MOD_SSL`, `abs` (ab with SSL support) and/or `MOD_DEFLATE`. VC++ 7.0 (.net) users also benefit, `nmake` builds are faster than `binenv` builds. Build the entire project from within the VC++ 5.0 or 6.0 IDE, then use the Project Menu Export for all makefiles. You must build the projects first in order to create all dynamic auto-generated targets, so that dependencies can be parsed correctly. Run the following command to fix the paths so they will build anywhere:

```
perl srclib\apr\build\fixwin32mak.pl
```

You must type this command from the *top level* directory of the `httpd` source tree. Every `.mak` and `.dep` project file within the current directory and below will be corrected, and the timestamps adjusted to reflect the `.dsp`.

If you contribute back a patch that revises project files, we must commit project files in Visual Studio 6.0 format. Changes should be simple, with minimal compilation and linkage flags that will be recognized by all VC++ 5.0 through 7.0 environments.

Project Components

The `Apache.dsw` workspace and `makefile.win` `nmake` script both build the `.dsp` projects of the Apache server in the following sequence:

1. `srclib\apr\apr.dsp`
2. `srclib\apr\libapr.dsp`
3. `srclib\apr-util\uri\gen_uri_delims.dsp`
4. `srclib\apr-util\xml\expat\lib\xml.dsp`
5. `srclib\apr-util\aprutil.dsp`
6. `srclib\apr-util\libaprutil.dsp`
7. `srclib\pcre\dftables.dsp`

8. srclib\pcre\pcre.dsp
9. srclib\pcre\pcreposix.dsp
10. server\gen_test_char.dsp
11. libhttpd.dsp
12. Apache.dsp

In addition, the `modules\` subdirectory tree contains project files for the majority of the modules.

The `support\` directory contains project files for additional programs that are not part of the Apache runtime, but are used by the administrator to test Apache and maintain password and log files. Windows-specific support projects are broken out in the `support\win32\` directory.

1. support\ab.dsp
2. support\htdigest.dsp
3. support\htpasswd.dsp
4. support\logresolve.dsp
5. support\rotatelogs.dsp
6. support\win32\ApacheMonitor.dsp
7. support\win32\wintty.dsp

Once Apache has been compiled, it needs to be installed in its server root directory. The default is the `\Apache2` directory, of the same drive.

To build and install all the files into the desired folder *dir* automatically, use one of the following `nmake` commands:

```
nmake /f Makefile.win installr INSTDIR=dir  
nmake /f Makefile.win installd INSTDIR=dir
```

The *dir* argument to `INSTDIR` gives the installation directory; it can be omitted if Apache is to be installed into `\Apache2`.

This will install the following:

- `dir\bin\Apache.exe` - Apache executable
- `dir\bin\ApacheMonitor.exe` - Service monitor taskbar icon utility
- `dir\bin\htdigest.exe` - Digest auth password file utility
- `dir\bin\htdbm.exe` - SDBM auth database password file utility
- `dir\bin\htpasswd.exe` - Basic auth password file utility
- `dir\bin\logresolve.exe` - Log file dns name lookup utility
- `dir\bin\rotatelogs.exe` - Log file cycling utility
- `dir\bin\wintty.exe` - Console window utility

- `dir\bin\libapr.dll` - Apache Portable Runtime shared library
- `dir\bin\libaprutil.dll` - Apache Utility Runtime shared library
- `dir\bin\libhttpd.dll` - Apache Core library
- `dir\modules\mod_*.so` - Loadable Apache modules
- `dir\conf` - Configuration directory
- `dir\logs` - Empty logging directory
- `dir\include` - C language header files
- `dir\lib` - Link library files

Warning about building Apache from the development tree

⇒ Note only the `.dsp` files are maintained between release builds. The `.mak` files are NOT regenerated, due to the tremendous waste of reviewer's time. Therefore, you cannot rely on the `NMAKE` commands above to build revised `.dsp` project files unless you then export all `.mak` files yourself from the project. This is unnecessary if you build from within the Microsoft Developer Studio environment.

⇒ Also note it is very worthwhile to build the `BuildBin` target project (or the command line `_apacher` or `_apached` target) prior to exporting the make files. Many files are autogenerated in the build process. Only a full build provides all of the dependent files required to build proper dependency trees for correct build behavior.

In order to create distribution `.mak` files, always review the generated `.mak` (or `.dep`) dependencies for Platform SDK or other garbage includes. The `DevStudio\SharedIDE\bin\` (VC5) or `DevStudio\Common\MSDev98\bin\` (VC6) directory contains the `sysincl.dat` file, which must list all exceptions. Update this file (including both forward and backslashed paths, such as both `sys/time.h` and `sys\time.h`) to include such dependencies. Including local-install paths in a distributed `.mak` file will cause the build to fail completely. And don't forget to run `srclib/apr/build/fixwin32mak.pl` in order to fix absolute paths within the `.mak` files.

7.4 Using Apache With Novell NetWare

This document explains how to install, configure and run Apache 2.0 under Novell NetWare 6.0 and above. If you find any bugs, or wish to contribute in other ways, please use our bug reporting page.⁵

The bug reporting page and dev-httpd mailing list are *not* provided to answer questions about configuration or running Apache. Before you submit a bug report or request, first consult this document, the Frequently Asked Questions (p. 140) page and the other relevant documentation topics. If you still have a question or problem, post it to the novell.devsup.webserver⁶ newsgroup, where many Apache users are more than willing to answer new and obscure questions about using Apache on NetWare.

Most of this document assumes that you are installing Apache from a binary distribution. If you want to compile Apache yourself (possibly to help with development, or to track down bugs), see the section on Compiling Apache for NetWare below.

Requirements

Apache 2.0 is designed to run on NetWare 6.0 service pack 3 and above. If you are running a service pack less than SP3, you must install the latest NetWare Libraries for C (LibC)⁷.

NetWare service packs are available here⁸.

Apache 2.0 for NetWare can also be run in a NetWare 5.1 environment as long as the latest service pack or the latest version of the NetWare Libraries for C (LibC)⁹ has been installed. **WARNING:** Apache 2.0 for NetWare has not been targeted for or tested in this environment.

Downloading Apache for NetWare

Information on the latest version of Apache can be found on the Apache web server at <http://www.apache.org/>. This will list the current release, any more recent alpha or beta-test releases, together with details of mirror web and anonymous ftp sites. Binary builds of the latest releases of Apache 2.0 for NetWare can be downloaded from here¹⁰.

Installing Apache for NetWare

There is no Apache install program for NetWare currently. If you are building Apache 2.0 for NetWare from source, you will need to copy the files over to the server manually.

Follow these steps to install Apache on NetWare from the binary download (assuming you will install to `sys:/apache2`):

- Unzip the binary download file to the root of the `SYS :` volume (may be installed to any volume)
- Edit the `httpd.conf` file setting `SERVERROOT` and `SERVERNAME` along with any file path values to reflect your correct server settings
- Add `SYS : /APACHE2` to the search path, for example:

```
SEARCH ADD SYS:\APACHE2
```

⁵http://httpd.apache.org/bug_report.html

⁶<news://developer-forums.novell.com/novell.devsup.webserver>

⁷<http://developer.novell.com/ndk/libc.htm>

⁸<http://support.novell.com/misc/patlst.htm#nw>

⁹<http://developer.novell.com/ndk/libc.htm>

¹⁰<http://www.apache.org/dist/httpd/binaries/netware>

Follow these steps to install Apache on NetWare manually from your own build source (assuming you will install to `sys:/apache2`):

- Create a directory called `Apache2` on a NetWare volume
- Copy `APACHE2.NLM`, `APRLIB.NLM` to `SYS:/APACHE2`
- Create a directory under `SYS:/APACHE2` called `BIN`
- Copy `HTDIGEST.NLM`, `HTPASSWD.NLM`, `HTDBM.NLM`, `LOGRES.NLM`, `ROTLOGS.NLM` to `SYS:/APACHE2/BIN`
- Create a directory under `SYS:/APACHE2` called `CONF`
- Copy the `HTTPD-STD.CONF` file to the `SYS:/APACHE2/CONF` directory and rename to `HTTPD.CONF`
- Copy the `MIME.TYPES`, `CHARSET.CONV` and `MAGIC` files to `SYS:/APACHE2/CONF` directory
- Copy all files and subdirectories in `\HTTPD-2.0\DOCS\ICONS` to `SYS:/APACHE2/ICONS`
- Copy all files and subdirectories in `\HTTPD-2.0\DOCS\MANUAL` to `SYS:/APACHE2/MANUAL`
- Copy all files and subdirectories in `\HTTPD-2.0\DOCS\ERROR` to `SYS:/APACHE2/ERROR`
- Copy all files and subdirectories in `\HTTPD-2.0\DOCS\DOCROOT` to `SYS:/APACHE2/HTDOCS`
- Create the directory `SYS:/APACHE2/LOGS` on the server
- Create the directory `SYS:/APACHE2/CGI-BIN` on the server
- Create the directory `SYS:/APACHE2/MODULES` and copy all nlm modules into the `modules` directory
- Edit the `HTTPD.CONF` file searching for all `@@Value@@` markers and replacing them with the appropriate setting
- Add `SYS:/APACHE2` to the search path, for example:

```
SEARCH ADD SYS:\APACHE2
```

Apache may be installed to other volumes besides the default `SYS` volume.

During the build process, adding the keyword "install" to the makefile command line will automatically produce a complete distribution package under the subdirectory `DIST`. Install Apache by simply copying the distribution that was produced by the makfiles to the root of a NetWare volume (see: [Compiling Apache for NetWare](#) below).

Running Apache for NetWare

To start Apache just type `apache` at the console. This will load apache in the OS address space. If you prefer to load Apache in a protected address space you may specify the address space with the load statement as follows:

```
load address space = apache2 apache2
```

This will load Apache into an address space called `apache2`. Running multiple instances of Apache concurrently on NetWare is possible by loading each instance into its own protected address space.

After starting Apache, it will be listening to port 80 (unless you changed the `LISTEN` directive in the configuration files). To connect to the server and access the default page, launch a browser and enter the server's name or address. This should respond with a welcome page, and a link to the Apache manual. If nothing happens or you get an error, look in the `error_log` file in the `logs` directory.

Once your basic installation is working, you should configure it properly by editing the files in the `conf` directory.

To unload Apache running in the OS address space just type the following at the console:

```
unload apache2
```

or

```
apache2 shutdown
```

If apache is running in a protected address space specify the address space in the unload statement:

```
unload address space = apache2 apache2
```

When working with Apache it is important to know how it will find the configuration files. You can specify a configuration file on the command line in two ways:

- `-f` specifies a path to a particular configuration file

```
apache2 -f "vol:/my_server/conf/my.conf"
```

```
apache -f test/test.conf
```

In these cases, the proper `SERVERROOT` should be set in the configuration file.

If you don't specify a configuration file name with `-f`, Apache will use the file name compiled into the server, usually `conf/httpd.conf`. Invoking Apache with the `-V` switch will display this value labeled as `SERVER_CONFIG_FILE`. Apache will then determine its `SERVERROOT` by trying the following, in this order:

- A `ServerRoot` directive via a `-C` switch.
- The `-d` switch on the command line.
- Current working directory
- The server root compiled into the server.

The server root compiled into the server is usually `sys:/apache2`. Invoking apache with the `-V` switch will display this value labeled as `HTTPD_ROOT`.

Apache 2.0 for NetWare includes a set of command line directives that can be used to modify or display information about the running instance of the web server. These directives are only available while Apache is running. Each of these directives must be preceded by the keyword `APACHE2`.

RESTART Instructs Apache to terminate all running worker threads as they become idle, reread the configuration file and restart each worker thread based on the new configuration.

VERSION Displays version information about the currently running instance of Apache.

MODULES Displays a list of loaded modules both built-in and external.

DIRECTIVES Displays a list of all available directives.

SETTINGS Enables or disables the thread status display on the console. When enabled, the state of each running threads is displayed on the Apache console screen.

SHUTDOWN Terminates the running instance of the Apache web server.

HELP Describes each of the runtime directives.

By default these directives are issued against the instance of Apache running in the OS address space. To issue a directive against a specific instance running in a protected address space, include the `-p` parameter along with the name of the address space. For more information type "apache2 Help" on the command line.

Configuring Apache for NetWare

Apache is configured by reading configuration files usually stored in the `conf` directory. These are the same as files used to configure the Unix version, but there are a few different directives for Apache on NetWare. See the Apache documentation (p. ??) for all the available directives.

The main differences in Apache for NetWare are:

- Because Apache for NetWare is multithreaded, it does not use a separate process for each request, as Apache does on some Unix implementations. Instead there are only threads running: a parent thread, and multiple child or worker threads which handle the requests.

Therefore the "process"-management directives are different:

MAXREQUESTSPERCHILD - Like the Unix directive, this controls how many requests a worker thread will serve before exiting. The recommended default, `MaxRequestsPerChild 0`, causes the thread to continue servicing request indefinitely. It is recommended on NetWare, unless there is some specific reason, that this directive always remain set to 0.

STARTTHREADS - This directive tells the server how many threads it should start initially. The recommended default is `StartThreads 50`.

MINSPARETHREADS - This directive instructs the server to spawn additional worker threads if the number of idle threads ever falls below this value. The recommended default is `MinSpareThreads 10`.

MAXSPARETHREADS - This directive instructs the server to begin terminating worker threads if the number of idle threads ever exceeds this value. The recommended default is `MaxSpareThreads 100`.

MAXTHREADS - This directive limits the total number of work threads to a maximum value. The recommended default is `ThreadsPerChild 250`.

THREADSTACKSIZE - This directive tells the server what size of stack to use for the individual worker thread. The recommended default is `ThreadStackSize 65536`.

- The directives that accept filenames as arguments must use NetWare filenames instead of Unix names. However, because Apache uses Unix-style names internally, forward slashes must be used rather than backslashes. It is recommended that all rooted file paths begin with a volume name. If omitted, Apache will assume the `SYS :` volume which may not be correct.
- Apache for NetWare has the ability to load modules at runtime, without recompiling the server. If Apache is compiled normally, it will install a number of optional modules in the `\Apache2\modules` directory. To activate these, or other modules, the **LOADMODULE** directive must be used. For example, to active the status module, use the following:

```
LoadModule status_module modules/status.nlm
```

Information on creating loadable modules (p. 545) is also available.

Additional NetWare specific directives:

- **CGIMAPEXTENSION** - This directive maps a CGI file extension to a script interpreter.
- **SECURELISTEN** - Enables SSL encryption for a specified port.
- **NWSSLTRUSTEDCERTS** - Adds trusted certificates that are used to create secure connections to proxied servers.
- **NWSSLUPGRADEABLE** - Allow a connection created on the specified address/port to be upgraded to an SSL connection.

Compiling Apache for NetWare

Compiling Apache requires MetroWerks CodeWarrior 6.x or higher. Once Apache has been built, it can be installed to the root of any NetWare volume. The default is the `sys:/Apache2` directory.

Before running the server you must fill out the `conf` directory. Copy the file `HTTPD-STD.CONF` from the distribution `conf` directory and rename it to `HTTPD.CONF`. Edit the `HTTPD.CONF` file searching for all `@@Value@@` markers and replacing them with the appropriate setting. Copy over the `conf/magic` and `conf/mime.types` files as well. Alternatively, a complete distribution can be built by including the keyword `install` when invoking the makefiles.

Requirements:

The following development tools are required to build Apache 2.0 for NetWare:

- Metrowerks CodeWarrior 6.0 or higher with the NetWare PDK 3.0¹¹ or higher.
- NetWare Libraries for C (LibC)¹²
- LDAP Libraries for C¹³
- ZLIB Compression Library source code¹⁴
- AWK utility (`awk`, `gawk` or similar). AWK can be downloaded from <http://developer.novell.com/ndk/apache.htm>. The utility must be found in your windows path and must be named `awk.exe`.
- To build using the makefiles, you will need GNU make version 3.78.1 (GMake) available at <http://developer.novell.com/ndk/apache.htm>.

Building Apache using the NetWare makefiles:

- Set the environment variable `NOVELLLIBC` to the location of the NetWare Libraries for C SDK, for example:

```
Set NOVELLLIBC=c:\novell\ndk\libc
```

- Set the environment variable `METROWERKS` to the location where you installed the Metrowerks CodeWarrior compiler, for example:

```
Set METROWERKS=C:\Program Files\Metrowerks\CodeWarrior
```

If you installed to the default location `C:\Program Files\Metrowerks\CodeWarrior`, you don't need to set this.

- Set the environment variable `LDAPSDK` to the location where you installed the LDAP Libraries for C, for example:

```
Set LDAPSDK=c:\Novell\NDK\cldapsdk\NetWare\libc
```

- Set the environment variable `ZLIBSDK` to the location where you installed the source code for the ZLib Library, for example:

¹¹<http://developer.novell.com/ndk/cwprdk.htm>

¹²<http://developer.novell.com/ndk/libc.htm>

¹³<http://developer.novell.com/ndk/cldap.htm>

¹⁴<http://www.gzip.org/zlib/>

```
Set ZLIBSDK=D:\NOVELL\zlib
```

- Set the environment variable `AP_WORK` to the full path of the `\httpd-2.0` directory.
- Set the environment variable `APR_WORK` to the full path of the `\httpd-2.0\srclib\apr` directory.
- Make sure that the path to the AWK utility and the GNU make utility (`gmake.exe`) have been included in the system's `PATH` environment variable.
- Download the source code and unzip to an appropriate directory on your workstation.
- Change directory to `\httpd-2.0\srclib\apr-util\uri` and build `GENURI.nlm` by running `"gmake -f nwgnumakefile"`.
- Copy the file `GENURI.nlm` to the `SYS:` volume of a NetWare server and run using the following command:

```
SYS:\genuri > sys:\uri\delims.h
```

- Copy the file `uri\delims.h` to the directory `\httpd-2.0\srclib\apr-util\uri` on the build machine.
- Change directory to `\httpd-2.0\srclib\apr` and build `APR` by running `"gmake -f nwgnumakefile"`
- Change directory to `\httpd-2.0\srclib\pcre` and build `DFTABLES.nlm` by running `"gmake -f nwgnumakefile"`
- Change directory to `\httpd-2.0\server` and build `GENCHARS.nlm` by running `"gmake -f nwgnumakefile"`
- Copy the files `GENCHARS.nlm` and `DFTABLES.nlm` from their respective directories to the `SYS:` volume of a NetWare server and run them using the following commands:

```
SYS:\genchars > sys:\test_char.h
SYS:\dftables > sys:\chartables.c
```

- Copy the files `test_char.h` and `chartables.c` to the directory `\httpd-2.0\os\netware` on the build machine.
- Change directory to `\httpd-2.0` and build Apache by running `"gmake -f nwgnumakefile"`. You can create a distribution directory by adding an `install` parameter to the command, for example:

```
gmake -f nwgnumakefile install
```

Additional make options

- `gmake -f nwgnumakefile` Builds release versions of all of the binaries and copies them to a `\release` destination directory.
- `gmake -f nwgnumakefile DEBUG=1` Builds debug versions of all of the binaries and copies them to a `\debug` destination directory.
- `gmake -f nwgnumakefile install` Creates a complete Apache distribution with binaries, docs and additional support files in a `\dist\Apache2` directory.
- `gmake -f nwgnumakefile installdev` Same as `install` but also creates a `\lib` and `\include` directory in the destination directory and copies headers and import files.
- `gmake -f nwgnumakefile clean` Cleans all object files and binaries from the `\release` or `\debug` build areas depending on whether `DEBUG` has been defined.
- `gmake -f nwgnumakefile clobber_all` Same as `clean` and also deletes the distribution directory if it exists.

7.5 Running a High-Performance Web Server on HP-UX

Date: Wed, 05 Nov 1997 16:59:34 -0800
From: Rick Jones <raj@cup.hp.com>
Reply-To: raj@cup.hp.com
Organization: Network Performance
Subject: HP-UX tuning tips

Here are some tuning tips for HP-UX to add to the tuning page.

For HP-UX 9.X: Upgrade to 10.20

For HP-UX 10.[00—01—10]: Upgrade to 10.20

For HP-UX 10.20:

Install the latest cumulative ARPA Transport Patch. This will allow you to configure the size of the TCP connection lookup hash table. The default is 256 buckets and must be set to a power of two. This is accomplished with `adb` against the `*disc*` image of the kernel. The variable name is `tcp_hash_size`. Notice that it's critically important that you use `"w"` to write a 32 bit quantity, not `"w"` to write a 16 bit value when patching the disc image because the `tcp_hash_size` variable is a 32 bit quantity.

How to pick the value? Examine the output of `ftp://ftp.cup.hp.com/dist/networking/tools/connhist (p. ??)` and see how many total TCP connections exist on the system. You probably want that number divided by the hash table size to be reasonably small, say less than 10. Folks can look at HP's SPECweb96 disclosures for some common settings. These can be found at <http://www.specbench.org/>. If an HP-UX system was performing at 1000 SPECweb96 connections per second, the `TIME_WAIT` time of 60 seconds would mean 60,000 TCP "connections" being tracked.

Folks can check their listen queue depths with `ftp://ftp.cup.hp.com/dist/networking/misc/listenq (p. ??)`.

If folks are running Apache on a PA-8000 based system, they should consider "chatr'ing" the Apache executable to have a large page size. This would be `"chatr +pi L <BINARY>"`. The GID of the running executable must have `MLOCK` privileges. `Setprivgrp(1m)` should be consulted for assigning `MLOCK`. The change can be validated by running `Glance` and examining the memory regions of the server(s) to make sure that they show a non-trivial fraction of the text segment being locked.

If folks are running Apache on MP systems, they might consider writing a small program that uses `mpctl()` to bind processes to processors. A simple `pid % numcpu` algorithm is probably sufficient. This might even go into the source code.

If folks are concerned about the number of `FIN_WAIT_2` connections, they can use `netttune` to shrink the value of `tcp_keepstart`. However, they should be careful there - certainly do not make it less than oh two to four minutes. If `tcp_hash_size` has been set well, it is probably OK to let the `FIN_WAIT_2`'s take longer to timeout (perhaps even the default two hours) - they will not on average have a big impact on performance.

There are other things that could go into the code base, but that might be left for another email. Feel free to drop me a message if you or others are interested.

sincerely,

rick jones

<http://www.cup.hp.com/netperf/NetperfPage.html>

7.6 The Apache EBCDIC Port



Warning: This document has not been updated to take into account changes made in the 2.0 version of the Apache HTTP Server. Some of the information may still be relevant, but please use it with care.

Overview of the Apache EBCDIC Port

Version 1.3 of the Apache HTTP Server is the first version which includes a port to a (non-ASCII) mainframe machine which uses the EBCDIC character set as its native codeset.

(It is the SIEMENS family of mainframes running the BS2000/OSD operating system¹⁵. This mainframe OS nowadays features a SVR4-derived POSIX subsystem).

The port was started initially to

- prove the feasibility of porting the Apache HTTP server¹⁶ to this platform
- find a "worthy and capable" successor for the venerable CERN-3.0¹⁷ daemon (which was ported a couple of years ago), and to
- prove that Apache's preforking process model can on this platform easily outperform the accept-fork-serve model used by CERN by a factor of 5 or more.

This document serves as a rationale to describe some of the design decisions of the port to this machine.

Design Goals

One objective of the EBCDIC port was to maintain enough backwards compatibility with the (EBCDIC) CERN server to make the transition to the new server attractive and easy. This required the addition of a configurable method to define whether a HTML document was stored in ASCII (the only format accepted by the old server) or in EBCDIC (the native document format in the POSIX subsystem, and therefore the only realistic format in which the other POSIX tools like `grep` or `sed` could operate on the documents). The current solution to this is a "pseudo-MIME-format" which is intercepted and interpreted by the Apache server (see below). Future versions might solve the problem by defining an "ebcdic-handler" for all documents which must be converted.

Technical Solution

Since all Apache input and output is based upon the BUFF data type and its methods, the easiest solution was to add the conversion to the BUFF handling routines. The conversion must be settable at any time, so a BUFF flag was added which defines whether a BUFF object has currently enabled conversion or not. This flag is modified at several points in the HTTP protocol:

- **set** before a request is received (because the request and the request header lines are always in ASCII format)
- **set/unset** when the request body is received - depending on the content type of the request body (because the request body may contain ASCII text or a binary file)
- **set** before a reply header is sent (because the response header lines are always in ASCII format)
- **set/unset** when the response body is sent - depending on the content type of the response body (because the response body may contain text or a binary file)

¹⁵http://www.siemens.de/servers/bs2osd/osdbc_us.htm

¹⁶<http://dev.apache.org/>

¹⁷<http://www.w3.org/Daemon/>

Porting Notes

1. The relevant changes in the source are `#ifdef`'ed into two categories:

`#ifdef CHARSET_EBCDIC` Code which is needed for any EBCDIC based machine. This includes character translations, differences in contiguity of the two character sets, flags which indicate which part of the HTTP protocol has to be converted and which part doesn't *etc.*

`#ifdef _OSD_POSIX` Code which is needed for the SIEMENS BS2000/OSD mainframe platform only. This deals with include file differences and socket implementation topics which are only required on the BS2000/OSD platform.

2. The possibility to translate between ASCII and EBCDIC at the socket level (on BS2000 POSIX, there is a socket option which supports this) was intentionally *not* chosen, because the byte stream at the HTTP protocol level consists of a mixture of protocol related strings and non-protocol related raw file data. HTTP protocol strings are always encoded in ASCII (the GET request, any Header: lines, the chunking information *etc.*) whereas the file transfer parts (*i.e.*, GIF images, CGI output *etc.*) should usually be just "passed through" by the server. This separation between "protocol string" and "raw data" is reflected in the server code by functions like `bgets()` or `rvputs()` for strings, and functions like `bwrite()` for binary data. A global translation of everything would therefore be inadequate.

(In the case of text files of course, provisions must be made so that EBCDIC documents are always served in ASCII)

3. This port therefore features a built-in protocol level conversion for the server-internal strings (which the compiler translated to EBCDIC strings) and thus for all server-generated documents. The hard coded ASCII escapes `\012` and `\015` which are ubiquitous in the server code are an exception: they are already the binary encoding of the ASCII `\n` and `\r` and must not be converted to ASCII a second time. This exception is only relevant for server-generated strings; and *external* EBCDIC documents are not expected to contain ASCII newline characters.
4. By examining the call hierarchy for the BUFF management routines, I added an "ebcdic/ascii conversion layer" which would be crossed on every `puts/write/get/gets`, and a conversion flag which allowed enabling/disabling the conversions on-the-fly. Usually, a document crosses this layer twice from its origin source (a file or CGI output) to its destination (the requesting client): `file -> Apache`, and `Apache -> client`.

The server can now read the header lines of a CGI-script output in EBCDIC format, and then find out that the remainder of the script's output is in ASCII (like in the case of the output of a WWW Counter program: the document body contains a GIF image). All header processing is done in the native EBCDIC format; the server then determines, based on the type of document being served, whether the document body (except for the chunking information, of course) is in ASCII already or must be converted from EBCDIC.

5. For Text documents (MIME types `text/plain`, `text/html` *etc.*), an implicit translation to ASCII can be used, or (if the users prefer to store some documents in raw ASCII form for faster serving, or because the files reside on a NFS-mounted directory tree) can be served without conversion.

Example:

to serve files with the suffix `.ahtml` as a raw ASCII `text/html` document without implicit conversion (and suffix `.ascii` as ASCII `text/plain`), use the directives:

```
AddType text/x-ascii-html .ahtml
AddType text/x-ascii-plain .ascii
```

Similarly, any `text/foo` MIME type can be served as "raw ASCII" by configuring a MIME type `"text/x-ascii-foo"` for it using `AddType`.

6. Non-text documents are always served "binary" without conversion. This seems to be the most sensible choice for, *e.g.*, GIF/ZIP/AU file types. This of course requires the user to copy them to the mainframe host using the `"rcp -b"` binary switch.

7. Server parsed files are always assumed to be in native (*i.e.*, EBCDIC) format as used on the machine, and are converted after processing.
8. For CGI output, the CGI script determines whether a conversion is needed or not: by setting the appropriate Content-Type, text files can be converted, or GIF output can be passed through unmodified. An example for the latter case is the `wwwcount` program which we ported as well.

Document Storage Notes

Binary Files

All files with a `Content-Type`: which does not start with `text/` are regarded as *binary files* by the server and are not subject to any conversion. Examples for binary files are GIF images, gzip-compressed files and the like.

When exchanging binary files between the mainframe host and a Unix machine or Windows PC, be sure to use the `ftp "binary" (TYPE I)` command, or use the `rcp -b` command from the mainframe host (the `-b` switch is not supported in unix `rcp`'s).

Text Documents

The default assumption of the server is that Text Files (*i.e.*, all files whose `Content-Type`: starts with `text/`) are stored in the native character set of the host, EBCDIC.

Server Side Included Documents

SSI documents must currently be stored in EBCDIC only. No provision is made to convert it from ASCII before processing.

Apache Modules' Status

Module	Status	Notes
CORE	+	
MOD_ACCESS	+	
MOD_ACTIONS	+	
MOD_ALIAS	+	
MOD_ASIS	+	
MOD_AUTH	+	
MOD_AUTH_ANON	+	
MOD_AUTH_DBM	?	with own <code>libdb.a</code>
MOD_AUTOINDEX	+	
MOD_CERN_META	?	
MOD_CGI	+	
mod_digest	+	
MOD_DIR	+	
MOD_SO	-	no shared libs
MOD_ENV	+	
MOD_EXAMPLE	-	(test bed only)
MOD_EXPIRES	+	
MOD_HEADERS	+	
MOD_IMAP	+	

MOD_INCLUDE	+	
MOD_INFO	+	
mod_log_agent	+	
MOD_LOG_CONFIG	+	
mod_log_referer	+	
MOD_MIME	+	
MOD_MIME_MAGIC	?	not ported yet
MOD_NEGOTIATION	+	
MOD_PROXY	+	
MOD_REWRITE	+	untested
MOD_SETENVIF	+	
MOD_SPELLING	+	
MOD_STATUS	+	
MOD_UNIQUE_ID	+	
MOD_USERDIR	+	
MOD_USERTRACK	?	untested

Third Party Modules' Status

Module	Status	Notes
mod_jserv ^a ^a http://java.apache.org/	-	JAVA still being ported.
mod_php3 ^a ^a http://www.php.net/	+	mod_php3 runs fine, with LDAP and GD and FreeType libraries.
mod_put ^a ^a http://hpwww.ec-lyon.fr/~vincent/apache/mod_put.html	?	untested
mod_session (p. ??)	-	untested

Chapter 8

Apache HTTP Server and Supporting Programs

8.1 Server and Supporting Programs

This page documents all the executable programs included with the Apache HTTP Server.

Index

httpd Apache hypertext transfer protocol server

apachectl Apache HTTP server control interface

ab Apache HTTP server benchmarking tool

apxs APache eXtenSion tool

configure Configure the source tree

dbmmanage Create and update user authentication files in DBM format for basic authentication

htdigest Create and update user authentication files for digest authentication

htdbm Manipulate DBM password databases.

htpasswd Create and update user authentication files for basic authentication

logresolve Resolve hostnames for IP-addresses in Apache logfiles

rotatelog Rotate Apache logs without having to kill the server

suexec Switch User For Exec

Other Programs (p. 269) Support tools with no own manual page.

8.2 httpd - Apache Hypertext Transfer Protocol Server

httpd is the Apache HyperText Transfer Protocol (HTTP) server program. It is designed to be run as a standalone daemon process. When used like this it will create a pool of child processes or threads to handle requests.

In general, httpd should not be invoked directly, but rather should be invoked via apachectl on Unix-based systems or as a service on Windows NT, 2000 and XP (p. 209) and as a console application on Windows 9x and ME (p. 209).

See also

- Starting Apache (p. 14)
- Stopping Apache (p. 16)
- Configuration Files (p. 19)
- Platform-specific Documentation (p. 208)
- apachectl

Synopsis

```
httpd [ -d serverroot ] [ -f config ] [ -C directive ] [ -c directive ] [ -D
parameter ] [ -e level ] [ -E file ] [ -k start|restart|graceful|stop ] [ -R
directory ] [ -h ] [ -l ] [ -L ] [ -S ] [ -t ] [ -v ] [ -V ] [ -X ]
```

On Windows systems (p. 209), the following additional arguments are available:

```
httpd [ -k install|config|uninstall ] [ -n name ] [ -w ]
```

Options

- d serverroot** Set the initial value for the `SERVERROOT` directive to serverroot. This can be overridden by the `ServerRoot` directive in the configuration file. The default is `/usr/local/apache2`.
- f config** Uses the directives in the file config on startup. If config does not begin with a `/`, then it is taken to be a path relative to the `SERVERROOT`. The default is `conf/httpd.conf`.
- k start|restart|graceful|stop** Signals httpd to start, restart, or stop. See Stopping Apache (p. 16) for more information.
- C directive** Process the configuration directive before reading config files.
- c directive** Process the configuration directive after reading config files.
- D parameter** Sets a configuration parameter which can be used with `<IFDEF>` sections in the configuration files to conditionally skip or process commands at server startup and restart.
- e level** Sets the `LOGLEVEL` to level during server startup. This is useful for temporarily increasing the verbosity of the error messages to find problems during startup.
- E file** Send error messages during server startup to file.
- R directory** When the server is compiled using the `SHARED_CORE` rule, this specifies the directory for the shared object files.
- h** Output a short summary of available command line options.
- l** Output a list of modules compiled into the server. This will **not** list dynamically loaded modules included using the `LOADMODULE` directive.

- L** Output a list of directives together with expected arguments and places where the directive is valid.
- S** Show the settings as parsed from the config file (currently only shows the virtualhost settings).
- t** Run syntax tests for configuration files only. The program immediately exits after these syntax parsing tests with either a return code of 0 (Syntax OK) or return code not equal to 0 (Syntax Error). If -D DUMP_VHOSTS is also set, details of the virtual host configuration will be printed.
- v** Print the version of `httpd`, and then exit.
- V** Print the version and build parameters of `httpd`, and then exit.
- X** Run `httpd` in debug mode. Only one worker will be started and the server will not detach from the console.

The following arguments are available only on the Windows platform (p. 209) :

- k** **install|config|uninstall** Install Apache as a Windows NT service; change startup options for the Apache service; and uninstall the Apache service.
- n** **name** The name of the Apache service to signal.
- w** Keep the console window open on error so that the error message can be read.

8.3 ab - Apache HTTP server benchmarking tool

ab is a tool for benchmarking your Apache Hypertext Transfer Protocol (HTTP) server. It is designed to give you an impression of how your current Apache installation performs. This especially shows you how many requests per second your Apache installation is capable of serving.

See also

- httpd

Synopsis

```
ab [ -A auth-username:password ] [ -c concurrency ] [ -C cookie-name=value ] [
-d ] [ -e csv-file ] [ -g gnuplot-file ] [ -h ] [ -H custom-header ] [ -i ] [
-k ] [ -n requests ] [ -p POST-file ] [ -P proxy-auth-username:password ] [ -q
] [ -s ] [ -S ] [ -t timelimit ] [ -T content-type ] [ -v verbosity ] [ -V ] [
-w ] [ -x <table>-attributes ] [ -X proxy[:port] ] [ -y <tr>-attributes ] [
-z <td>-attributes ] [http://]hostname[:port]/path
```

Options

- A auth-username:password** Supply BASIC Authentication credentials to the server. The username and password are separated by a single `:` and sent on the wire base64 encoded. The string is sent regardless of whether the server needs it (*i.e.*, has sent an 401 authentication needed).
- c concurrency** Number of multiple requests to perform at a time. Default is one request at a time.
- C cookie-name=value** Add a `Cookie:` line to the request. The argument is typically in the form of a `name=value` pair. This field is repeatable.
- d** Do not display the "percentage served within XX [ms] table". (legacy support).
- e csv-file** Write a Comma separated value (CSV) file which contains for each percentage (from 1% to 100%) the time (in milliseconds) it took to serve that percentage of the requests. This is usually more useful than the 'gnuplot' file; as the results are already 'binned'.
- g gnuplot-file** Write all measured values out as a 'gnuplot' or TSV (Tab separate values) file. This file can easily be imported into packages like Gnuplot, IDL, Mathematica, Igor or even Excel. The labels are on the first line of the file.
- h** Display usage information.
- H custom-header** Append extra headers to the request. The argument is typically in the form of a valid header line, containing a colon-separated field-value pair (*i.e.*, "Accept-Encoding: zip/zop;8bit").
- i** Do HEAD requests instead of GET.
- k** Enable the HTTP KeepAlive feature, *i.e.*, perform multiple requests within one HTTP session. Default is no KeepAlive.
- n requests** Number of requests to perform for the benchmarking session. The default is to just perform a single request which usually leads to non-representative benchmarking results.
- p POST-file** File containing data to POST.

- P proxy-auth-username:password** Supply BASIC Authentication credentials to a proxy en-route. The username and password are separated by a single `:` and sent on the wire base64 encoded. The string is sent regardless of whether the proxy needs it (*i.e.*, has sent an 407 proxy authentication needed).
- q** When processing more than 150 requests, `ab` outputs a progress count on `stderr` every 10% or 100 requests or so. The `-q` flag will suppress these messages.
- s** When compiled in (`ab -h` will show you) use the SSL protected `https` rather than the `http` protocol. This feature is experimental and *very* rudimentary. You probably do not want to use it.
- S** Do not display the median and standard deviation values, nor display the warning/error messages when the average and median are more than one or two times the standard deviation apart. And default to the min/avg/max values. (legacy support).
- t timelimit** Maximum number of seconds to spend for benchmarking. This implies a `-n 50000` internally. Use this to benchmark the server within a fixed total amount of time. Per default there is no timelimit.
- T content-type** Content-type header to use for POST data.
- v verbosity** Set verbosity level - 4 and above prints information on headers, 3 and above prints response codes (404, 200, etc.), 2 and above prints warnings and info.
- V** Display version number and exit.
- w** Print out results in HTML tables. Default table is two columns wide, with a white background.
- x <table>-attributes** String to use as attributes for `<table>`. Attributes are inserted `<table here >`.
- X proxy[:port]** Use a proxy server for the requests.
- y <tr>-attributes** String to use as attributes for `<tr>`.
- z <td>-attributes** String to use as attributes for `<td>`.

Bugs

There are various statically declared buffers of fixed length. Combined with the lazy parsing of the command line arguments, the response headers from the server and other external inputs, this might bite you.

It does not implement HTTP/1.x fully; only accepts some 'expected' forms of responses. The rather heavy use of `strstr(3)` shows up top in profile, which might indicate a performance problem; *i.e.*, you would measure the `ab` performance rather than the server's.

8.4 apachectl - Apache HTTP Server Control Interface

`apachectl` is a front end to the Apache HyperText Transfer Protocol (HTTP) server. It is designed to help the administrator control the functioning of the Apache `httpd` daemon.

The `apachectl` script can operate in two modes. First, it can act as a simple front-end to the `httpd` command that simply sets any necessary environment variables and then invokes `httpd`, passing through any command line arguments. Second, `apachectl` can act as a SysV init script, taking simple one-word arguments like `start`, `restart`, and `stop`, and translating them into appropriate signals to `httpd`.

If your Apache installation uses non-standard paths, you will need to edit the `apachectl` script to set the appropriate paths to the `httpd` binary. You can also specify any necessary `httpd` command line arguments. See the comments in the script for details.

The `apachectl` script returns a 0 exit value on success, and >0 if an error occurs. For more details, view the comments in the script.

See also

- Starting Apache (p. 14)
- Stopping Apache (p. 16)
- Configuration Files (p. 19)
- Platform Docs (p. 208)
- `httpd`

Synopsis

When acting in pass-through mode, `apachectl` can take all the arguments available for the `httpd` binary.

```
apachectl [ httpd-argument ]
```

When acting in SysV init mode, `apachectl` takes simple, one-word commands, defined below.

```
apachectl command
```

Options

Only the SysV init-style options are defined here. Other arguments are defined on the `httpd` manual page.

start Start the Apache `httpd` daemon. Gives an error if it is already running. This is equivalent to `apachectl -k start`.

stop Stops the Apache `httpd` daemon. This is equivalent to `apachectl -k stop`.

restart Restarts the Apache `httpd` daemon. If the daemon is not running, it is started. This command automatically checks the configuration files as in `configtest` before initiating the restart to make sure the daemon doesn't die. This is equivalent to `apachectl -k restart`.

fullstatus Displays a full status report from `MOD_STATUS`. For this to work, you need to have `MOD_STATUS` enabled on your server and a text-based browser such as `lynx` available on your system. The URL used to access the status report can be set by editing the `STATUSURL` variable in the script.

status Displays a brief status report. Similar to the `fullstatus` option, except that the list of requests currently being served is omitted.

graceful Gracefully restarts the Apache httpd daemon. If the daemon is not running, it is started. This differs from a normal restart in that currently open connections are not aborted. A side effect is that old log files will not be closed immediately. This means that if used in a log rotation script, a substantial delay may be necessary to ensure that the old log files are closed before processing them. This command automatically checks the configuration files as in `configtest` before initiating the restart to make sure Apache doesn't die. This is equivalent to `apachectl -k graceful`.

configtest Run a configuration file syntax test. It parses the configuration files and either reports `Syntax Ok` or detailed information about the particular syntax error. This is equivalent to `apachectl -t`.

The following additional option is available, but deprecated.

startssl This is equivalent to `apachectl -k start -DSSL`. We recommend that you use that command explicitly, or you adjust your `httpd.conf` to remove the `<IFDEF>` section so that SSL will always be available.

8.5 apxs - APache eXtenSion tool

apxs is a tool for building and installing extension modules for the Apache HyperText Transfer Protocol (HTTP) server. This is achieved by building a dynamic shared object (DSO) from one or more source or object files which then can be loaded into the Apache server under runtime via the `LOADMODULE` directive from `MOD_SO`.

So to use this extension mechanism your platform has to support the DSO feature and your Apache httpd binary has to be built with the `MOD_SO` module. The apxs tool automatically complains if this is not the case. You can check this yourself by manually running the command

```
$ httpd -l
```

The module `MOD_SO` should be part of the displayed list. If these requirements are fulfilled you can easily extend your Apache server's functionality by installing your own modules with the DSO mechanism by the help of this apxs tool:

```
$ apxs -i -a -c mod.foo.c
gcc -fpic -DSHARED_MODULE -I/path/to/apache/include -c mod.foo.c
ld -Bshareable -o mod.foo.so mod.foo.o
cp mod.foo.so /path/to/apache/modules/mod.foo.so
chmod 755 /path/to/apache/modules/mod.foo.so
[activating module 'foo' in /path/to/apache/etc/httpd.conf]
$ apachectl restart
/path/to/apache/sbin/apachectl restart: httpd not running, trying to
start
[Tue Mar 31 11:27:55 1998] [debug] mod.so.c(303): loaded module
foo_module
/path/to/apache/sbin/apachectl restart: httpd started
$ -
```

The arguments files can be any C source file (.c), a object file (.o) or even a library archive (.a). The apxs tool automatically recognizes these extensions and automatically used the C source files for compilation while just using the object and archive files for the linking phase. But when using such pre-compiled objects make sure they are compiled for position independent code (PIC) to be able to use them for a dynamically loaded shared object. For instance with GCC you always just have to use `-fpic`. For other C compilers consult its manual page or at watch for the flags apxs uses to compile the object files.

For more details about DSO support in Apache read the documentation of `MOD_SO` or perhaps even read the `src/modules/standard/mod_so.c` source file.

See also

- apachectl
- httpd

Synopsis

```
apxs -g [ -S name=value ] -n modname
```

```
apxs -q [ -S name=value ] query ...
```

```
apxs -c [ -S name=value ] [ -o dsofile ] [ -I incdir ] [ -D name=value ] [ -L
libdir ] [ -l libname ] [ -Wc, compiler-flags ] [ -Wl, linker-flags ] files ...
```

```
apxs -i [ -S name=value ] [ -n modname ] [ -a ] [ -A ] dso-file ...
```

```
apxs -e [ -S name=value ] [ -n modname ] [ -a ] [ -A ] dso-file ...
```

Options

Common Options

- n modname** This explicitly sets the module name for the `-i` (install) and `-g` (template generation) option. Use this to explicitly specify the module name. For option `-g` this is required, for option `-i` the `apxs` tool tries to determine the name from the source or (as a fallback) at least by guessing it from the filename.

Query Options

- q** Performs a query for `apxs`'s knowledge about certain settings. The query parameters can be one or more of the following strings: `CC`, `CFLAGS`, `CFLAGS_SHLIB`, `INCLUDEDIR`, `LD_SHLIB`, `LD_FLAGS_SHLIB`, `LIBEXECDIR`, `LIBS_SHLIB`, `SBINDIR`, `SYSCONFDIR`, `TARGET`.

Use this for manually determining settings. For instance use

```
INC=-I`apxs -q INCLUDEDIR`
```

inside your own Makefiles if you need manual access to Apache's C header files.

Configuration Options

- S name=value** This option changes the `apxs` settings described above.

Template Generation Options

- g** This generates a subdirectory name (see option `-n`) and there two files: A sample module source file named `mod_name.c` which can be used as a template for creating your own modules or as a quick start for playing with the `apxs` mechanism. And a corresponding `Makefile` for even easier build and installing of this module.

DSO Compilation Options

- c** This indicates the compilation operation. It first compiles the C source files (`.c`) of files into corresponding object files (`.o`) and then builds a dynamically shared object in `dsfile` by linking these object files plus the remaining object files (`.o` and `.a`) of files. If no `-o` option is specified the output file is guessed from the first filename in files and thus usually defaults to `mod_name.so`.
- o dsfile** Explicitly specifies the filename of the created dynamically shared object. If not specified and the name cannot be guessed from the files list, the fallback name `mod_unknown.so` is used.
- D name=value** This option is directly passed through to the compilation command(s). Use this to add your own defines to the build process.
- I incdir** This option is directly passed through to the compilation command(s). Use this to add your own include directories to search to the build process.
- L libdir** This option is directly passed through to the linker command. Use this to add your own library directories to search to the build process.
- l libname** This option is directly passed through to the linker command. Use this to add your own libraries to search to the build process.

- Wc, compiler-flags** This option passes compiler-flags as additional flags to the compiler command. Use this to add local compiler-specific options.
- Wl, linker-flags** This option passes linker-flags as additional flags to the linker command. Use this to add local linker-specific options.

DSO Installation and Configuration Options

- i** This indicates the installation operation and installs one or more dynamically shared objects into the server's modules directory.
- a** This activates the module by automatically adding a corresponding **LOADMODULE** line to Apache's `httpd.conf` configuration file, or by enabling it if it already exists.
- A** Same as option `-a` but the created **LOADMODULE** directive is prefixed with a hash sign (`#`), *i.e.*, the module is just prepared for later activation but initially disabled.
- e** This indicates the editing operation, which can be used with the `-a` and `-A` options similarly to the `-i` operation to edit Apache's `httpd.conf` configuration file without attempting to install the module.

Examples

Assume you have an Apache module named `mod.foo.c` available which should extend Apache's server functionality. To accomplish this you first have to compile the C source into a shared object suitable for loading into the Apache server under runtime via the following command:

```
$ apxs -c mod.foo.c
gcc -fpic -DSHARED_MODULE -I/path/to/apache/include -c mod.foo.c
ld -Bshareable -o mod.foo.so mod.foo.o
$ -
```

Then you have to update the Apache configuration by making sure a **LOADMODULE** directive is present to load this shared object. To simplify this step `apxs` provides an automatic way to install the shared object in its "modules" directory and updating the `httpd.conf` file accordingly. This can be achieved by running:

```
$ apxs -i -a mod.foo.c
cp mod.foo.so /path/to/apache/modules/mod.foo.so
chmod 755 /path/to/apache/modules/mod.foo.so
[activating module 'foo' in /path/to/apache/etc/httpd.conf]
$ -
```

This way a line named

```
LoadModule foo_module modules/mod.foo.so
```

is added to the configuration file if still not present. If you want to have this disabled per default use the `-A` option, *i.e.*

```
$ apxs -i -A mod.foo.c
```

For a quick test of the `apxs` mechanism you can create a sample Apache module template plus a corresponding Makefile via:

```
$ apxs -g -n foo
Creating [DIR] foo
Creating [FILE] foo/Makefile
Creating [FILE] foo/mod.foo.c
$ -
```

Then you can immediately compile this sample module into a shared object and load it into the Apache server:

```
$ cd foo
$ make all reload
apxs -c mod.foo.c
gcc -fpic -DSHARED_MODULE -I/path/to/apache/include -c mod.foo.c
ld -Bshareable -o mod.foo.so mod.foo.o
apxs -i -a -n "foo" mod.foo.so
cp mod.foo.so /path/to/apache/modules/mod.foo.so
chmod 755 /path/to/apache/modules/mod.foo.so
[activating module 'foo' in /path/to/apache/etc/httpd.conf]
apachectl restart
/path/to/apache/sbin/apachectl restart: httpd not running, trying to
start
[Tue Mar 31 11:27:55 1998] [debug] mod.so.c(303): loaded module
foo_module
/path/to/apache/sbin/apachectl restart: httpd started
$ -
```

You can even use `apxs` to compile complex modules outside the Apache source tree, like PHP3:

```
$ cd php3
$ ./configure --with-shared-apache=../apache-1.3
$ apxs -c -o libphp3.so mod_php3.c libmodphp3-so.a
gcc -fpic -DSHARED_MODULE -I/tmp/apache/include -c mod_php3.c
ld -Bshareable -o libphp3.so mod_php3.o libmodphp3-so.a
$ -
```

because `apxs` automatically recognized C source files and object files. Only C source files are compiled while remaining object files are used for the linking phase.

8.6 configure - Configure the source tree

The `configure` script configures the source tree for compiling and installing the Apache HTTP Server on your particular platform. Various options allow the compilation of a server corresponding to your personal requirements.

This script, included in the root directory of the source distribution, is for compilation on Unix and Unix-like systems only. For other platforms, see the platform (p. 208) documentation.

See also

- Compiling and Installing (p. 10)

Synopsis

You should call the `configure` script from within the root directory of the distribution.

```
./configure [OPTION]... [VAR=VALUE]...
```

To assign environment variables (e.g. `CC`, `CFLAGS` ...), specify them as `VAR=VALUE`. See below for descriptions of some of the useful variables.

Options

- Configuration options
- Installation directories
- System types
- Optional features
- Options for support programs

Configuration options

The following options influence the behavior of `configure` itself.

-C

--config-cache This is an alias for `--cache-file=config.cache`

--cache-file=FILE The test results will be cached in file `FILE`. This option is disabled by default.

-h

--help [short|recursive] Output the help and exit. With the argument `short` only options specific to this package will be displayed. The argument `recursive` displays the short help of all the included packages.

-n

--no-create The `configure` script is run normally but does not create output files. This is useful to check the test results before generating makefiles for compilation.

-q

--quiet Do not print `checking ...` messages during the configure process.

--srcdir=DIR Defines directory `DIR` to be the source file directory. Default is the directory, where `configure` is located, or the parent directory ...

--silent Same as `--quiet`

-V

--version Display copyright information and exit.

Installation directories

These options define the installation directory. The installation tree depends on the selected layout.

--prefix=PREFIX Install architecture-independent files in PREFIX. By default the installation directory is set to `/usr/local/apache2`.

--exec-prefix=EPREFIX Install architecture-dependent files in EPREFIX. By default the installation directory is set to the PREFIX directory.

By default, `make install` will install all the files in `/usr/local/apache2/bin`, `/usr/local/apache2/lib` etc. You can specify an installation prefix other than `/usr/local/apache2` using `--prefix`, for instance `--prefix=$HOME`.

Define a directory layout

--enable-layout=LAYOUT Configure the source code and build scripts to assume an installation tree based on the layout LAYOUT. This allows you to separately specify the locations for each type of file within the Apache HTTP Server installation. The `config.layout` file contains several example configurations, and you can also create your own custom configuration following the examples. The different layouts in this file are grouped into `<Layout FOO>...</Layout>` sections and referred to by name as in FOO. The default layout is Apache.

Fine tuning of the installation directories

For better control of the installation directories, use the options below. Please note that the directory defaults are set by `autoconf` and be overwritten by the corresponding layout setting.

--bindir=DIR Install user executables in DIR. The user executables are supporting programs like `htpasswd`, `dbmmanage`, etc. which are useful for site administrators. By default DIR is set to `EPREFIX/bin`.

--datadir=DIR Install read-only architecture-independent data in DIR. By default `datadir` is set to `PREFIX/share`. This option is offered by `autoconf` and currently unused.

--includedir=DIR Install C header files in DIR. By default `includedir` is set to `EPREFIX/include`.

--infodir=DIR Install info documentation in DIR. By default `infodir` is set to `PREFIX/info`. This option is currently unused.

--libdir=DIR Install object code libraries in DIR. By default `libdir` is set to `EPREFIX/lib`.

--libexecdir=DIR Install the program executables (i.e., shared modules) in DIR. By default `libexecdir` is set to `EPREFIX/libexec`.

--localstatedir=DIR Install modifiable single-machine data in DIR. By default `localstatedir` is set to `PREFIX/var`. This option is offered by `autoconf` and currently unused.

--mandir=DIR Install the man documentation in DIR. By default `mandir` is set to `EPREFIX/man`.

--oldincludedir=DIR Install C header files for non-gcc in DIR. By default `oldincludedir` is set to `/usr/include`. This option is offered by `autoconf` and currently unused.

--sbindir=DIR Install the system administrator executables in DIR. Those are server programs like `httpd`, `apachectl`, `suexec`, etc. which are necessary to run the Apache HTTP Server. By default `sbindir` is set to `EPREFIX/sbin`.

--sharedstatedir=DIR Install modifiable architecture-independent data in DIR. By default `sharedstatedir` is set to `PREFIX/com`. This option is offered by `autoconf` and currently unused.

--sysconfdir=DIR Install read-only single-machine data like the server configuration files `httpd.conf`, `mime.types`, etc. in DIR. By default `sysconfdir` is set to `PREFIX/etc`.

System types

These options are used to cross-compile the Apache HTTP Server to run on another system. In normal cases, when building and running the server on the same system, these options are not used.

--build=BUILD Defines the system type of the system on which the tools are being built. It defaults to the result of the script `config.guess`.

--host=HOST Defines the system type of the system on which the server will run. `HOST` defaults to `BUILD`.

--target=TARGET Configure for building compilers for the system type `TARGET`. It defaults to `HOST`. This option is offered by `autoconf` and not necessary for the Apache HTTP Server.

Optional Features

These options are used to fine tune the features your HTTP server will have.

General syntax

Generally you can use the following syntax to enable or disable a feature:

--disable-FEATURE Do not include FEATURE. This is the same as `--enable-FEATURE=no`.

--enable-FEATURE [=ARG] Include FEATURE. The default value for ARG is `yes`.

--enable-MODULE=shared The corresponding module will be build as DSO module.

--enable-MODULE=static By default enabled modules are linked statically. You can force this explicitly.

⇒ Note

`configure` will not complain about `--enable-foo` even if `foo` doesn't exist, so you need to type carefully.

Modules enabled by default

Some modules are compiled by default and have to be disabled explicitly. Use the following options to remove discrete modules from the compilation process.

- disable-actions** Disable action triggering on requests, which is provided by [MOD_ACTIONS](#).
- disable-alias** Disable the mapping of requests to different parts of the filesystem, which is provided by [MOD_ALIAS](#).
- disable-asis** Disable support for as-is filetypes, which is provided by [MOD_ASIS](#).
- disable-auth** Disable user-based access control provided by [MOD_AUTH](#). This module provides for HTTP Basic Authentication, where the usernames and passwords are stored in plain text files.
- disable-autoindex** Disable the directory listing functionality provided by [MOD_AUTOINDEX](#).
- disable-access** Disable host-based access control provided by [MOD_ACCESS](#).
- disable-cgi** [MOD_CGI](#), which provides support for CGI scripts, is enabled by default when using a non-threaded MPM. Use this option to disable CGI support.
- disable-cgid** When using the threaded MPMs [WORKER](#) or [PERCHILD](#) support for CGI scripts is provided by [MOD_CGID](#) by default. To disable CGI support use this option.
- disable-charset-lite** Disable character set translation provided by [MOD_CHARSET_LITE](#). This module will be installed by default only on EBCDIC systems.
- disable-dir** Disable directory request handling provided by [MOD_DIR](#).
- disable-env** Disable setting and clearing of environment variables, which is provided by [MOD_ENV](#).
- disable-http** Disable the HTTP protocol handling. The `http` module is a basic one, enabling the server to function as an HTTP server. It is only useful to disable it if you want to use another protocol module instead. **Don't disable this module unless you are really sure what you are doing.**
Note: This module will always be linked statically.
- disable-imap** Disable support for server based imagemaps, which provided by [MOD_IMAP](#).
- disable-include** Disable Server Side Includes provided by [MOD_INCLUDE](#).
- disable-log-config** Disable the logging configuration provided by [MOD_LOG_CONFIG](#). You won't be able to log requests to the server without this module.
- disable-mime** [MOD_MIME](#) associates the requested filename's extensions with the file's behavior and content (mime-type, language, character set and encoding). Disabling the mapping of file-extensions to MIME is normally not recommended.
- disable-negotiation** Disable content negotiation provided by [MOD_NEGOTIATION](#).
- disable-setenvif** Disable support for basing environment variables on headers, which is provided by [MOD_SETENVIF](#).
- disable-status** Disable the process/thread monitoring, which is provided by [MOD_STATUS](#).
- disable-userdir** Disable the mapping of requests to user-specific directories, which is provided by [MOD_USERDIR](#).

Modules, disabled by default

Some modules are compiled by default and have to be enabled explicitly or by using the keywords `most` or `all` (see `--enable-mods-shared` below for further explanation) to be available. Therefore use the options below.

- `--enable-auth-anon`** Enable anonymous user access provided by [MOD_AUTH_ANON](#).
- `--enable-auth-dbm`** [MOD_AUTH_DBM](#) provides for HTTP Basic Authentication, where the usernames and passwords are stored in DBM type database files. Use this option to enable the module.
- `--enable-auth-digest`** Enable RFC2617 Digest authentication provided by [MOD_AUTH_DIGEST](#). This module uses plain text files to store the credentials.
- `--enable-auth-ldap`** Enable LDAP based authentication provided by [MOD_AUTH_LDAP](#).
- `--enable-cache`** Enable dynamic file caching provided by [MOD_CACHE](#). This experimental module may be interesting for servers with high load or caching proxy servers. At least one storage management module (e.g. [MOD_DISK_CACHE](#) or [MOD_MEM_CACHE](#)) is also necessary.
- `--enable-cern-meta`** Enable the CERN-type meta files support provided by [MOD_CERN_META](#).
- `--enable-charset-lite`** Enable character set translation provided by [MOD_CHARSET_LITE](#). This module will be installed by default only on EBCDIC systems. On other systems, you have to enable it.
- `--enable-dav`** Enable the WebDAV protocol handling provided by [MOD_DAV](#). Support for filesystem resources is provided by the separate module [MOD_DAV_FS](#). This module is also automatically enabled with `--enable-dav`.
Note: [MOD_DAV](#) can only be used together with the `http` protocol module.
- `--enable-dav-fs`** Enable DAV support for filesystem resources, which is provided by [MOD_DAV_FS](#). This module is a provider for the [MOD_DAV](#) module, so you should also use `--enable-dav`.
- `--enable-deflate`** Enable deflate transfer encoding provided by [MOD_DEFLATE](#).
- `--enable-disk-cache`** Enable disk caching provided by [MOD_DISK_CACHE](#).
- `--enable-expires`** Enable Expires header control provided by [MOD_EXPIRES](#).
- `--enable-ext-filter`** Enable the external filter support provided by [MOD_EXT_FILTER](#).
- `--enable-file-cache`** Enable the file cache provided by [MOD_FILE_CACHE](#).
- `--enable-headers`** Enable control of HTTP headers provided by [MOD_HEADERS](#).
- `--enable-info`** Enable the server information provided by [MOD_INFO](#).
- `--enable-ldap`** Enable LDAP caching and connection pooling services provided by [MOD_LDAP](#).
- `--enable-logio`** Enable logging of input and output bytes including headers provided by [MOD_LOGIO](#).
- `--enable-mem-cache`** Enable memory caching provided by [MOD_MEM_CACHE](#).
- `--enable-mime-magic`** Enable automatical determining of MIME types, which is provided by [MOD_MIME_MAGIC](#).
- `--enable-isapi`** Enable the isapi extension support provided by [MOD_ISAPI](#).
- `--enable-proxy`** Enable the proxy/gateway functionality provided by [MOD_PROXY](#). The proxying capabilities for `CONNECT`, `FTP` and `HTTP` are provided by the separate modules [MOD_PROXY_CONNECT](#), [MOD_PROXY_FTP](#) and [MOD_PROXY_HTTP](#). These three modules are also automatically enabled with `--enable-proxy`.

- enable-proxy-connect** Enable proxy support for `CONNECT` request handling, which is provided by `MOD_PROXY_CONNECT`. This module is an extension for the `MOD_PROXY` module, so you should also use `--enable-proxy`.
- enable-proxy-ftp** Enable proxy support for `FTP` requests, which is provided by `MOD_PROXY_FTP`. This module is an extension for the `MOD_PROXY` module, so you should also use `--enable-proxy`.
- enable-proxy-http** Enable proxy support for `HTTP` requests, which is provided by `MOD_PROXY_HTTP`. This module is an extension for the `MOD_PROXY` module, so you should also use `--enable-proxy`.
- enable-rewrite** Enable rule based URL manipulation provided by `MOD_REWRITE`.
- enable-so** Enable DSO capability provided by `MOD_SO`. This module will be automatically enabled if you use the `--enable-mods-shared` option.
- enable-spelling** Enable the functionality to correct common URL misspellings, which is provided by `MOD_SPELLING`.
- enable-ssl** Enable support for `SSL/TLS` provided by `MOD_SSL`.
- enable-unique-id** Enable the generation of per-request unique ids, which is provided by `MOD_UNIQUE_ID`.
- enable-usertrack** Enable user-session tracking provided by `MOD_USERTRACK`.
- enable-vhost-alias** Enable mass virtual hosting provided by `MOD_VHOST_ALIAS`.

Modules for developers

The following modules are useful only for developers and testing purposes and are disabled by default. Use the following options to enable them. If you are not sure whether you need one of these modules, omit them.

- enable-bucketeer** Enable the manipulation filter for buckets, which is provided by `mod_bucketeer`.
- enable-case-filter** Enable the example uppercase conversion output filter support of `mod_case_filter`.
- enable-case-filter-in** Enable the example uppercase conversion input filter support of `mod_case_filter_in`.
- enable-echo** Enable the `ECHO` server provided by `MOD_ECHO`.
- enable-example** Enable the example and demo module `MOD_EXAMPLE`.
- enable-optional-fn-export** Enable the example for an optional function exporter, which is provided by `mod_optional_fn_export`.
- enable-optional-fn-import** Enable the example for an optional function importer, which is provided by `mod_optional_fn_import`.
- enable-optional-hook-export** Enable the example for an optional hook exporter, which is provided by `mod_optional_hook_export`.
- enable-optional-hook-import** Enable the example optional hook importer, which is provided by `mod_optional_hook_import`.

MPMs and third-party modules

To add the necessary Multi Processing Module and additional third-party modules use the following options:

--with-module=module-type:module-file[, module-type:module-file] Add one or more third-party modules to the list of statically linked modules. The module source file `module-file` will be searched in the `modules/module-type` subdirectory of your Apache HTTP server source tree. If it is not found there `configure` is considering `module-file` to be an absolute file path and tries to copy the source file into the `module-type` subdirectory. If the subdirectory doesn't exist it will be created and populated with a standard `Makefile.in`.

This option is useful to add small external modules consisting of one source file. For more complex modules you should read the vendor's documentation.

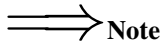

If you want to build a DSO module instead of a statically linked use `apxs`.

--with-mpm=MPM Choose the process model for your server. You have to select exactly one Multi-Processing Module (p. 59). Otherwise the default MPM (p. 59) for your operating system will be taken. Possible MPMs are `BEOS`, `LEADER`, `MPMT_OS2`, `PERCHILD`, `PREFORK`, `THREADPOOL` and `WORKER`.

Cumulative and other options

--enable-maintainer-mode Turn on debugging and compile time warnings.

--enable-mods-shared=MODULE-LIST Defines a list of modules to be enabled and build as dynamic shared modules. This mean, these module have to be loaded dynamically by using the `LOADMODULE` directive.

`MODULE-LIST` is a space separated list of modulenames enclosed by quotation marks. The module names are given without the preceding `mod_`. For example:

```
--enable-mods-shared='headers rewrite dav'
```

Additionally you can use the special keywords `all` and `most`. For example,

```
--enable-mods-shared=most
```

will compile most modules and build them as DSO modules.

--enable-modules=MODULE-LIST This option behaves similar to `--enable-mods-shared`, but will link the given modules statically. This mean, these modules will always be present while running `httpd`. They need not be loaded with `LOADMODULE`.

--enable-v4-mapped Allow IPv6 sockets to handle IPv4 connections.

--with-port=PORT This defines the port on which `httpd` will listen. This port number is used when generating the configuration file `httpd.conf`. The default is 80.

--with-program-name Define an alternative executable name. The default is `httpd`.

Optional packages

These options are used to define optional packages.

General syntax

Generally you can use the following syntax to define an optional package:

--with-PACKAGE [=ARG] Use the package PACKAGE. The default value for ARG is yes.

--without-PACKAGE Do not use the package PACKAGE. This is the same as `--with-PACKAGE=no`. This option is provided by `autoconf` but not very useful for the Apache HTTP Server.

Specific packages

--with-apr=DIR|FILE The Apache Portable Runtime (APR) is part of the `httpd` source distribution and will automatically be build together with the HTTP server. If you want to use an already installed APR instead you have to tell `configure` the path to the `apr-config` script. You may set the absolute path and name or the directory to the installed APR. `apr-config` must exists within this directory or the subdirectory `bin`.

--with-apr-util=DIR|FILE The Apache Portable Runtime Utilities (APU) are part of the `httpd` source distribution and will automatically be build together with the HTTP server. If you want to use an already installed APU instead you have to tell `configure` the path to the `apu-config` script. You may set the absolute path and name or the directory to the installed APU. `apu-config` must exists within this directory or the subdirectory `bin`.

--with-ssl=DIR If `MOD_SSL` has been enabled `configure` searches for an installed OpenSSL. You can set the directory path to the SSL/TLS toolkit instead.

--with-z=DIR `configure` searches automatically for an installed `zlib` library if your source configuration requires one (e.g., when `MOD_DEFLATE` is enabled). You can set the directory path to the compression library instead.

Several features of the Apache HTTP Server, including `MOD_AUTHN_DBM` and `MOD_REWRITE`'s `DBM_REWRITEMAP` use simple key/value databases for quick lookups of information. `SDBM` is included in the APU, so this database is always available. If you would like to use other database types, use the following options to enable them:

--with-gdbm [=path] If no path is specified, `configure` will search for the include files and libraries of a GNU DBM installation in the usual search paths. An explicit path will cause `configure` to look in `path/lib` and `path/include` for the relevant files. Finally, the path may specify specific include and library paths separated by a colon.

--with-ndbm [=path] Like `--with-gdbm`, but searches for a New DBM installation.

--with-berkeley-db [=path] Like `--with-gdbm`, but searches for a Berkeley DB installation.

⇒ Note

The DBM options are provided by the APU and passed through to its configuration script. They are useless when using an already installed APU defined by `--with-apr-util`. You may use more then one DBM implementation together with your HTTP server. The appropriated DBM type will be configured within the runtime configuration at each time.

Options for support programs

- enable-static-support** Build a statically linked version of the support binaries. This means, a stand-alone executable will be built with all the necessary libraries integrated. Otherwise the support binaries are linked dynamically by default.
- enable-suexec** Use this option to enable suexec, which allows you to set uid and gid for spawned processes. **Do not use this option unless you understand all the security implications of running a suid binary on your server.** Further options to configure suexec are described below.

It is possible to create a statically linked binary of a single support program by using the following options:

- enable-static-ab** Build a statically linked version of ab.
- enable-static-checkgid** Build a statically linked version of checkgid.
- enable-static-htdbm** Build a statically linked version of htdbm.
- enable-static-htdigest** Build a statically linked version of htdigest.
- enable-static-htpasswd** Build a statically linked version of htpasswd.
- enable-static-logresolve** Build a statically linked version of logresolve.
- enable-static-rotatelog** Build a statically linked version of rotatelog.

suexec configuration options

The following options are used to fine tune the behavior of suexec. See [Configuring and installing suEXEC \(p. 268\)](#) for further information.

- with-suexec-bin** This defines the path to suexec binary. Default is `--sbindir` (see [Fine tuning of installation directories \(p. ??\)](#)).
- with-suexec-caller** This defines the user allowed to call suexec. It should be the same as the user under which httpd normally runs.
- with-suexec-docroot** This defines the directory tree under which suexec access is allowed for executables. Default value is `--datadir/htdocs`.
- with-suexec-gidmin** Define this as the lowest GID allowed to be a target user for suexec. The default value is 100.
- with-suexec-logfile** This defines the filename of the suexec logfile. By default the logfile is named `suexec_log` and located in `--logfiledir`.
- with-suexec-safepath** Define the value of the environment variable `PATH` to be set for processes started by suexec. Default value is `/usr/local/bin:/usr/bin:/bin`.
- with-suexec-userdir** This defines the subdirectory under the user's directory that contains all executables for which suexec access is allowed. This setting is necessary when you want to use suexec together with user-specific directories (as provided by [MOD_USERDIR](#)). The default is `public_html`.
- with-suexec-uidmin** Define this as the lowest UID allowed to be a target user for suexec. The default value is 100.
- with-suexec-umask** Set `umask` for processes started by suexec. It defaults to your system settings.

Environment variables

There are some useful environment variables to override the choices made by `configure` or to help it to find libraries and programs with nonstandard names or locations.

CC Define the C compiler command to be used for compilation.

CFLAGS Set C compiler flags you want to use for compilation.

CPP Define the C preprocessor command to be used.

CPPFLAGS Set C/C++ preprocessor flags, e.g. `-Iincludedir` if you have headers in a nonstandard directory `includedir`.

LDLFLAGS Set linker flags, e.g. `-Llibdir` if you have libraries in a nonstandard directory `libdir`.

8.7 dbmmanage - Manage user authentication files in DBM format

dbmmanage is used to create and update the DBM format files used to store usernames and password for basic authentication of HTTP users via [MOD_AUTH_DBM](#). Resources available from the Apache HTTP server can be restricted to just the users listed in the files created by dbmmanage. This program can only be used when the usernames are stored in a DBM file. To use a flat-file database see htpasswd.

This manual page only lists the command line arguments. For details of the directives necessary to configure user authentication in httpd see the httpd manual, which is part of the Apache distribution or can be found at <http://httpd.apache.org/>.

See also

- [httpd](#)
- [MOD_AUTH_DBM](#)

Synopsis

```
dbmmanage [ encoding ] filename add|adduser|check|delete|update username [
encpasswd [ group[,group...] [ comment ] ] ]
```

```
dbmmanage filename view [ username ]
```

```
dbmmanage filename import
```

Options

filename The filename of the DBM format file. Usually without the extension `.db`, `.pag`, or `.dir`.

username The user for which the operations are performed. The username may not contain a colon (`:`).

encpasswd This is the already encrypted password to use for the `update` and `add` commands. You may use a hyphen (`-`) if you want to get prompted for the password, but fill in the fields afterwards. Additionally when using the `update` command, a period (`.`) keeps the original password untouched.

group A group, which the user is member of. A groupname may not contain a colon (`:`). You may use a hyphen (`-`) if you don't want to assign the user to a group, but fill in the comment field. Additionally when using the `update` command, a period (`.`) keeps the original groups untouched.

comment This is the place for your opaque comments about the user, like realname, mailaddress or such things. The server will ignore this field.

Encodings

-d crypt encryption (default, except on Win32, Netware)

-m MD5 encryption (default on Win32, Netware)

-s SHA1 encryption

-p plaintext (*not recommended*)

Commands

add Adds an entry for username to filename using the encrypted password `encpasswd`.

```
dbmmanage passwords.dat add rbowen foKntnEF3KSXA
```

adduser Asks for a password and then adds an entry for username to filename.

```
dbmmanage passwords.dat adduser krietz
```

check Asks for a password and then checks if username is in filename and if its password matches the specified one.

```
dbmmanage passwords.dat check rbowen
```

delete Deletes the username entry from filename.

```
dbmmanage passwords.dat delete rbowen
```

import Reads `username:password` entries (one per line) from `STDIN` and adds them to filename. The passwords already have to be crypted.

update Same as the `adduser` command, except that it makes sure username already exists in filename.

```
dbmmanage passwords.dat update rbowen
```

view Just displays the contents of the DBM file. If you specify a username, it displays the particular record only.

```
dbmmanage passwords.dat view
```

Bugs

One should be aware that there are a number of different DBM file formats in existence, and with all likelihood, libraries for more than one format may exist on your system. The three primary examples are SDBM, NDBM, the GNU project's GDBM, and Berkeley DB 2. Unfortunately, all these libraries use different file formats, and you must make sure that the file format used by filename is the same format that `dbmmanage` expects to see. `dbmmanage` currently has no way of determining what type of DBM file it is looking at. If used against the wrong format, will simply return nothing, or may create a different DBM file with a different name, or at worst, it may corrupt the DBM file if you were attempting to write to it.

`dbmmanage` has a list of DBM format preferences, defined by the `@AnyDBM::ISA` array near the beginning of the program. Since we prefer the Berkeley DB 2 file format, the order in which `dbmmanage` will look for system libraries is Berkeley DB 2, then NDBM, then GDBM and then SDBM. The first library found will be the library `dbmmanage` will attempt to use for all DBM file transactions. This ordering is slightly different than the standard `@AnyDBM::ISA` ordering in Perl, as well as the ordering used by the simple `dbmopen()` call in Perl, so if you use any other utilities to manage your DBM files, they must also follow this preference ordering. Similar care must be taken if using programs in other languages, like C, to access these files.

One can usually use the `file` program supplied with most Unix systems to see what format a DBM file is in.

8.8 htldb - Manipulate DBM password databases

htldb is used to manipulate the DBM format files used to store usernames and password for basic authentication of HTTP users via [MOD_AUTH_DBM](#). See the dbmmanage documentation for more information about these DBM files.

See also

- [httpd](#)
- [dbmmanage](#)
- [MOD_AUTH_DBM](#)

Synopsis

```
htldb [ -TDBTYPE ] [ -c ] [ -m | -d | -p | -s ] [ -t ] [ -v ] [ -x ] filename
username

htldb -b [ -TDBTYPE ] [ -c ] [ -m | -d | -p | -s ] [ -t ] [ -v ] filename
username password

htldb -n [ -c ] [ -m | -d | -p | -s ] [ -t ] [ -v ] username

htldb -nb [ -c ] [ -m | -d | -p | -s ] [ -t ] [ -v ] username password

htldb -v [ -TDBTYPE ] [ -c ] [ -m | -d | -p | -s ] [ -t ] [ -v ] filename
username

htldb -vb [ -TDBTYPE ] [ -c ] [ -m | -d | -p | -s ] [ -t ] [ -v ] filename
username password

htldb -x [ -TDBTYPE ] [ -m | -d | -p | -s ] filename username

htldb -l [ -TDBTYPE ]
```

Options

- b Use batch mode; *i.e.*, get the password from the command line rather than prompting for it. This option should be used with extreme care, since **the password is clearly visible** on the command line.
- c Create the passwdfile. If passwdfile already exists, it is rewritten and truncated. This option cannot be combined with the -n option.
- n Display the results on standard output rather than updating a database. This option changes the syntax of the command line, since the passwdfile argument (usually the first one) is omitted. It cannot be combined with the -c option.
- m Use MD5 encryption for passwords. On Windows, Netware and TPF, this is the default.
- d Use `crypt()` encryption for passwords. The default on all platforms but Windows, Netware and TPF. Though possibly supported by htldb on all platforms, it is not supported by the httpd server on Windows, Netware and TPF.
- s Use SHA encryption for passwords. Facilitates migration from/to Netscape servers using the LDAP Directory Interchange Format (ldif).
- p Use plaintext passwords. Though htldb will support creation on all platforms, the httpd daemon will only accept plain text passwords on Windows, Netware and TPF.
- l Print each of the usernames and comments from the database on stdout.

- t** Interpret the final parameter as a comment. When this option is specified, an additional string can be appended to the command line; this string will be stored in the "Comment" field of the database, associated with the specified username.
 - v** Verify the username and password. The program will print a message indicating whether the supplied password is valid. If the password is invalid, the program exits with error code 3.
 - x** Delete user. If the username exists in the specified DBM file, it will be deleted.
- filename** The filename of the DBM format file. Usually without the extension `.db`, `.pag`, or `.dir`. If `-c` is given, the DBM file is created if it does not already exist, or updated if it does exist.
- username** The username to create or update in passwdfile. If username does not exist in this file, an entry is added. If it does exist, the password is changed.
- password** The plaintext password to be encrypted and stored in the DBM file. Used only with the `-b` flag.
- TDBTYPE** Type of DBM file (SDBM, GDBM, DB, or "default").

Bugs

One should be aware that there are a number of different DBM file formats in existence, and with all likelihood, libraries for more than one format may exist on your system. The three primary examples are SDBM, NDBM, GNU GDBM, and Berkeley/Sleepycat DB 2/3/4. Unfortunately, all these libraries use different file formats, and you must make sure that the file format used by filename is the same format that `htdbm` expects to see. `htdbm` currently has no way of determining what type of DBM file it is looking at. If used against the wrong format, will simply return nothing, or may create a different DBM file with a different name, or at worst, it may corrupt the DBM file if you were attempting to write to it.

One can usually use the `file` program supplied with most Unix systems to see what format a DBM file is in.

Exit Status

`htdbm` returns a zero status ("true") if the username and password have been successfully added or updated in the DBM File. `htdbm` returns 1 if it encounters some problem accessing files, 2 if there was a syntax problem with the command line, 3 if the password was entered interactively and the verification entry didn't match, 4 if its operation was interrupted, 5 if a value is too long (username, filename, password, or final computed record), 6 if the username contains illegal characters (see the Restrictions section), and 7 if the file is not a valid DBM password file.

Examples

```
htdbm /usr/local/etc/apache/.htdbm-users jsmith
```

Adds or modifies the password for user `jsmith`. The user is prompted for the password. If executed on a Windows system, the password will be encrypted using the modified Apache MD5 algorithm; otherwise, the system's `crypt()` routine will be used. If the file does not exist, `htdbm` will do nothing except return an error.

```
htdbm -c /home/does/public_html/.htdbm jane
```

Creates a new file and stores a record in it for user `jane`. The user is prompted for the password. If the file exists and cannot be read, or cannot be written, it is not altered and `htdbm` will display a message and return an error status.

```
htdbm -mb /usr/web/.htdbm-all jones Pwd4Steve
```

Encrypts the password from the command line (Pwd4Steve) using the MD5 algorithm, and stores it in the specified file.

Security Considerations

Web password files such as those managed by `htdbm` should *not* be within the Web server's URI space – that is, they should not be fetchable with a browser.

The use of the `-b` option is discouraged, since when it is used the unencrypted password appears on the command line.

Restrictions

On the Windows and MPE platforms, passwords encrypted with `htdbm` are limited to no more than 255 characters in length. Longer passwords will be truncated to 255 characters.

The MD5 algorithm used by `htdbm` is specific to the Apache software; passwords encrypted using it will not be usable with other Web servers.

Username are limited to 255 bytes and may not include the character `:.:`

8.9 htdigest - manage user files for digest authentication

`htdigest` is used to create and update the flat-files used to store usernames, realm and password for digest authentication of HTTP users. Resources available from the Apache HTTP server can be restricted to just the users listed in the files created by `htdigest`.

This manual page only lists the command line arguments. For details of the directives necessary to configure digest authentication in `httpd` see the Apache manual, which is part of the Apache distribution or can be found at <http://httpd.apache.org/>.

See also

- `httpd`
- [MOD_AUTH_DIGEST](#)

Synopsis

```
htdigest [ -c ] passwdfile realm username
```

Options

-c Create the passwdfile. If passwdfile already exists, it is deleted first.

passwdfile Name of the file to contain the username, realm and password. If **-c** is given, this file is created if it does not already exist, or deleted and recreated if it does exist.

realm The realm name to which the user name belongs.

username The user name to create or update in passwdfile. If username does not exist in this file, an entry is added. If it does exist, the password is changed.

8.10 htpasswd - Manage user files for basic authentication

htpasswd is used to create and update the flat-files used to store usernames and password for basic authentication of HTTP users. If htpasswd cannot access a file, such as not being able to write to the output file or not being able to read the file in order to update it, it returns an error status and makes no changes.

Resources available from the Apache HTTP server can be restricted to just the users listed in the files created by htpasswd. This program can only manage usernames and passwords stored in a flat-file. It can encrypt and display password information for use in other types of data stores, though. To use a DBM database see dbmmanage.

htpasswd encrypts passwords using either a version of MD5 modified for Apache, or the system's `crypt()` routine. Files managed by htpasswd may contain both types of passwords; some user records may have MD5-encrypted passwords while others in the same file may have passwords encrypted with `crypt()`.

This manual page only lists the command line arguments. For details of the directives necessary to configure user authentication in httpd see the Apache manual, which is part of the Apache distribution or can be found at <http://httpd.apache.org/>¹.

See also

- httpd
- The scripts in support/SHA1 which come with the distribution.

Synopsis

```
htpasswd [ -c ] [ -m ] [ -D ] passwdfile username
htpasswd -b [ -c ] [ -m | -d | -p | -s ] [ -D ] passwdfile username password
htpasswd -n [ -m | -d | -s | -p ] username
htpasswd -nb [ -m | -d | -s | -p ] username password
```

Options

- b** Use batch mode; *i.e.*, get the password from the command line rather than prompting for it. This option should be used with extreme care, since **the password is clearly visible** on the command line.
- c** Create the passwdfile. If passwdfile already exists, it is rewritten and truncated. This option cannot be combined with the **-n** option.
- n** Display the results on standard output rather than updating a file. This is useful for generating password records acceptable to Apache for inclusion in non-text data stores. This option changes the syntax of the command line, since the passwdfile argument (usually the first one) is omitted. It cannot be combined with the **-c** option.
- m** Use MD5 encryption for passwords. On Windows, Netware and TPF, this is the default.
- d** Use `crypt()` encryption for passwords. The default on all platforms but Windows, Netware and TPF. Though possibly supported by htpasswd on all platforms, it is not supported by the httpd server on Windows, Netware and TPF.
- s** Use SHA encryption for passwords. Facilitates migration from/to Netscape servers using the LDAP Directory Interchange Format (ldif).
- p** Use plaintext passwords. Though htpasswd will support creation on all platforms, the httpd daemon will only accept plain text passwords on Windows, Netware and TPF.

¹<http://httpd.apache.org>

-D Delete user. If the username exists in the specified `htpasswd` file, it will be deleted.

passwdfile Name of the file to contain the user name and password. If `-c` is given, this file is created if it does not already exist, or rewritten and truncated if it does exist.

username The username to create or update in `passwdfile`. If `username` does not exist in this file, an entry is added. If it does exist, the password is changed.

password The plaintext password to be encrypted and stored in the file. Only used with the `-b` flag.

Exit Status

`htpasswd` returns a zero status ("true") if the username and password have been successfully added or updated in the `passwdfile`. `htpasswd` returns 1 if it encounters some problem accessing files, 2 if there was a syntax problem with the command line, 3 if the password was entered interactively and the verification entry didn't match, 4 if its operation was interrupted, 5 if a value is too long (username, filename, password, or final computed record), 6 if the username contains illegal characters (see the Restrictions section), and 7 if the file is not a valid password file.

Examples

```
htpasswd /usr/local/etc/apache/.htpasswd-users jsmith
```

Adds or modifies the password for user `jsmith`. The user is prompted for the password. If executed on a Windows system, the password will be encrypted using the modified Apache MD5 algorithm; otherwise, the system's `crypt()` routine will be used. If the file does not exist, `htpasswd` will do nothing except return an error.

```
htpasswd -c /home/does/public.html/.htpasswd jane
```

Creates a new file and stores a record in it for user `jane`. The user is prompted for the password. If the file exists and cannot be read, or cannot be written, it is not altered and `htpasswd` will display a message and return an error status.

```
htpasswd -mb /usr/web/.htpasswd-all jones Pwd4Steve
```

Encrypts the password from the command line (`Pwd4Steve`) using the MD5 algorithm, and stores it in the specified file.

Security Considerations

Web password files such as those managed by `htpasswd` should *not* be within the Web server's URI space – that is, they should not be fetchable with a browser.

The use of the `-b` option is discouraged, since when it is used the unencrypted password appears on the command line.

Restrictions

On the Windows and MPE platforms, passwords encrypted with `htpasswd` are limited to no more than 255 characters in length. Longer passwords will be truncated to 255 characters.

The MD5 algorithm used by `htpasswd` is specific to the Apache software; passwords encrypted using it will not be usable with other Web servers.

Usernames are limited to 255 bytes and may not include the character `:`.

8.11 logresolve - Resolve IP-addresses to hostnames in Apache log files

logresolve is a post-processing program to resolve IP-addresses in Apache's access logfiles. To minimize impact on your nameserver, logresolve has its very own internal hash-table cache. This means that each IP number will only be looked up the first time it is found in the log file.

Takes an Apache log file on standard input. The IP addresses must be the first thing on each line and must be separated from the remainder of the line by a space.

Synopsis

```
logresolve [ -s filename ] [ -c ] < access_log > access_log.new
```

Options

- s filename** Specifies a filename to record statistics.
- c** This causes logresolve to apply some DNS checks: after finding the hostname from the IP address, it looks up the IP addresses for the hostname and checks that one of these matches the original address.

8.12 rotatelog - Piped logging program to rotate Apache logs

rotatelog is a simple program for use in conjunction with Apache's piped logfile feature. For example:

```
CustomLog "|bin/rotatelog /var/logs/logfile 86400" common
```

This creates the files `/var/logs/logfile.nnnn` where `nnnn` is the system time at which the log nominally starts (this time will always be a multiple of the rotation time, so you can synchronize cron scripts with it). At the end of each rotation time (here after 24 hours) a new log is started.

```
CustomLog "|bin/rotatelog /var/logs/logfile 5M" common
```

This configuration will rotate the logfile whenever it reaches a size of 5 megabytes.

```
ErrorLog "|bin/rotatelog /var/logs/errorlog.%Y-%m-%d-%H_%M_%S 5M"
```

This configuration will rotate the error logfile whenever it reaches a size of 5 megabytes, and the suffix to the logfile name will be created of the form `errorlog.YYYY-mm-dd-HH_MM_SS`.

Synopsis

```
rotatelog [ -1 ] logfile [ rotationtime [ offset ] ] | [ filesizeM ]
```

Options

-1 (2.0.51 and later) Causes the use of local time rather than GMT as the base for the interval. Note that using `-1` in an environment which changes the GMT offset (such as for BST or DST) can lead to unpredictable results!

logfile The path plus basename of the logfile. If logfile includes any `'%'` characters, it is treated as a format string for `strftime(3)`. Otherwise, the suffix `.nnnnnnnnn` is automatically added and is the time in seconds. Both formats compute the start time from the beginning of the current period.

rotationtime The time between log file rotations in seconds.

offset The number of minutes offset from UTC. If omitted, zero is assumed and UTC is used. For example, to use local time in the zone UTC -5 hours, specify a value of `-300` for this argument.

filesizeM The maximum file size in megabytes followed by the letter `M` to specify size rather than time. Use this parameter in place of both `rotationtime` and `offset`.

Portability

The following logfile format string substitutions should be supported by all `strftime(3)` implementations, see the `strftime(3)` man page for library-specific extensions.

<code>%A</code>	full weekday name (localized)
<code>%a</code>	3-character weekday name (localized)
<code>%B</code>	full month name (localized)

%b	3-character month name (localized)
%c	date and time (localized)
%d	2-digit day of month
%H	2-digit hour (24 hour clock)
%I	2-digit hour (12 hour clock)
%j	3-digit day of year
%M	2-digit minute
%m	2-digit month
%p	am/pm of 12 hour clock (localized)
%S	2-digit second
%U	2-digit week of year (Sunday first day of week)
%W	2-digit week of year (Monday first day of week)
%w	1-digit weekday (Sunday first day of week)
%X	time (localized)
%x	date (localized)
%Y	4-digit year
%y	2-digit year
%Z	time zone name
%%	literal '%'

8.13 suexec - Switch user before executing external programs

`suexec` is used by the Apache HTTP Server to switch to another user before executing CGI programs. In order to achieve this, it must run as `root`. Since the HTTP daemon normally doesn't run as `root`, the `suexec` executable needs the `setuid` bit set and must be owned by `root`. It should never be writable for any other person than `root`.

For further information about the concepts and the security model of `suexec` please refer to the `suexec` documentation (<http://httpd.apache.org/docs/2.0/suexec.html>).

Synopsis

suexec -V

Options

-V If you are `root`, this option displays the compile options of `suexec`. For security reasons all configuration options are changeable only at compile time.

8.14 Other Programs

The following programs are simple support programs included with the Apache HTTP Server which do not have their own manual pages. They are not installed automatically. You can find them after the configuration process in the `support/` directory.

log_server_status

This perl script is designed to be run at a frequent interval by something like cron. It connects to the server and downloads the status information. It reformats the information to a single line and logs it to a file. Adjust the variables at the top of the script to specify the location of the resulting logfile.

split-logfile

This perl script will take a combined Web server access log file and break its contents into separate files. It assumes that the first field of each line is the virtual host identity (put there by "%v"), and that the logfiles should be named that + ".log" in the current directory.

The combined log file is read from stdin. Records read will be appended to any existing log files.

Chapter 9

Apache Miscellaneous Documentation

9.1 Apache Miscellaneous Documentation

Below is a list of additional documentation pages that apply to the Apache web server development project.



Warning

Some of the documents below have not been fully updated to take into account changes made in the 2.0 version of the Apache HTTP Server. Some of the information may still be relevant, but please use it with care.

How to use XSSI and Negotiation for custom ErrorDocuments (p. 273) Describes a solution which uses XSSI and negotiation to custom-tailor the Apache ErrorDocuments to taste, adding the advantage of returning internationalized versions of the error messages depending on the client's language preferences.

File Descriptor use in Apache (p. 291) Describes how Apache uses file descriptors and talks about various limits imposed on the number of descriptors available by various operating systems.

FIN_WAIT_2 (p. 281) A description of the causes of Apache processes going into the `FIN_WAIT_2` state, and what you can do about it.

Known Client Problems (p. 286) A list of problems in HTTP clients which can be mitigated by Apache.

Performance Notes - Apache Tuning (p. 73) Notes about how to (run-time and compile-time) configure Apache for highest performance. Notes explaining why Apache does some things, and why it doesn't do other things (which make it slower/faster).

Security Tips (p. 40) Some "do"s - and "don't"s - for keeping your Apache web site secure.

URL Rewriting Guide (p. 85) This document supplements the `MOD_REWRITE` reference documentation (p. 521) . It describes how one can use Apache's `MOD_REWRITE` to solve typical URL-based problems webmasters are usually confronted with in practice.

Apache Tutorials (p. 204) A list of external resources which help to accomplish common tasks with the Apache HTTP server.

Relevant Standards (p. 294) This document acts as a reference page for most of the relevant standards that Apache follows.

9.2 International Customized Server Error Messages

**Warning:**

This document has not been fully updated to take into account changes made in the 2.0 version of the Apache HTTP Server. Some of the information may still be relevant, but please use it with care.

This document describes an easy way to provide your Apache HTTP Server with a set of customized error messages which take advantage of Content Negotiation (p. 47) and `MOD_INCLUDE` to return error messages generated by the server in the client's native language.

Introduction

By using SSI, all `ERRORDOCUMENT` messages can share a homogenous and consistent style and layout, and maintenance work (changing images, changing links) is kept to a minimum because all layout information can be kept in a single file.

Error documents can be shared across different servers, or even hosts, because all varying information is inserted at the time the error document is returned on behalf of a failed request.

Content Negotiation then selects the appropriate language version of a particular error message text, honoring the language preferences passed in the client's request. (Users usually select their favorite languages in the preferences options menu of today's browsers). When an error document in the client's primary language version is unavailable, the secondary languages are tried or a default (fallback) version is used.

You have full flexibility in designing your error documents to your personal taste (or your company's conventions). For demonstration purposes, we present a simple generic error document scheme. For this hypothetical server, we assume that all error messages...

- possibly are served by different virtual hosts (different host name, different IP address, or different port) on the server machine,
- show a predefined company logo in the right top of the message (selectable by virtual host),
- print the error title first, followed by an explanatory text and (depending on the error context) help on how to resolve the error,
- have some kind of standardized background image,
- display an apache logo and a feedback email address at the bottom of the error message.

An example of a "document not found" message for a german client might look like this:



All links in the document as well as links to the server's administrator mail address, and even the name and port of the serving virtual host are inserted in the error document at "run-time", i.e., when the error actually occurs.

Creating an ErrorDocument directory

For this concept to work as easily as possible, we must take advantage of as much server support as we can get:

1. By defining the MultiViews [OPTIONS](#), we enable the language selection of the most appropriate language alternative (content negotiation).
2. By setting the [LANGUAGEPRIORITY](#) directive we define a set of default fallback languages in the situation where the client's browser did not express any preference at all.
3. By enabling [MOD_INCLUDE](#) (and disallowing execution of cgi scripts for security reasons), we allow the server to include building blocks of the error message, and to substitute the value of certain environment variables into the generated document (dynamic HTML) or even to conditionally include or omit parts of the text.
4. The [ADDHANDLER](#) and [ADDTYPE](#) directives are useful for automatically SSI-expanding all files with a `.shtml` suffix to `text/html`.
5. By using the [ALIAS](#) directive, we keep the error document directory outside of the document tree because it can be regarded more as a server part than part of the document tree.
6. The `<DIRECTORY>` block restricts these "special" settings to the error document directory and avoids an impact on any of the settings for the regular document tree.

7. For each of the error codes to be handled (see RFC2068 for an exact description of each error code, or look at `src/main/http_protocol.c` if you wish to see apache's standard messages), an **ERRORDOCUMENT** in the aliased `/errordocs` directory is defined. Note that we only define the basename of the document here because the `MultiViews` option will select the best candidate based on the language suffixes and the client's preferences. Any error situation with an error code *not* handled by a custom document will be dealt with by the server in the standard way (*i.e.*, a plain error message in english).
8. Finally, the **ALLOWOVERRIDE** directive tells apache that it is not necessary to look for a `.htaccess` file in the `/errordocs` directory: a minor speed optimization.

The resulting `httpd.conf` configuration would then look similar to this:

⇒ Note

Note that you can define your own error messages using this method for only part of the document tree, e.g., a `/user/` subtree. In this case, the configuration could as well be put into the `.htaccess` file at the root of the subtree, and the `<Directory>` and `</Directory>` directives -but not the contained directives- must be omitted.

```
LanguagePriority en fr de
Alias /errordocs /usr/local/apache/errordocs
<Directory /usr/local/apache/errordocs>
    AllowOverride none
    Options MultiViews IncludesNoExec FollowSymLinks
    AddType text/html .shtml
    <FilesMatch "\.shtml[.]">
        SetOutputFilter INCLUDES
    </FilesMatch>
</Directory>
# "400 Bad Request",
ErrorDocument 400 /errordocs/400
# "401 Authorization Required",
ErrorDocument 401 /errordocs/401
# "403 Forbidden",
ErrorDocument 403 /errordocs/403
# "404 Not Found",
ErrorDocument 404 /errordocs/404
# "500 Internal Server Error",
ErrorDocument 500 /errordocs/500
```

The directory for the error messages (here: `/usr/local/apache/errordocs/`) must then be created with the appropriate permissions (readable and executable by the server uid or gid, only writable for the administrator).

Naming the Individual Error Document files

By defining the `MultiViews` option, the server was told to automatically scan the directory for matching variants (looking at language and content type suffixes) when a requested document was not found. In the configuration, we defined the names for the error documents to be just their error number (without any suffix).

The names of the individual error documents are now determined like this (I'm using 403 as an example, think of it as a placeholder for any of the configured error documents):

- No file `errordocs/403` should exist. Otherwise, it would be found and served (with the `DefaultType`, usually `text/plain`), all negotiation would be bypassed.

- For each language for which we have an internationalized version (note that this need not be the same set of languages for each error code - you can get by with a single language version until you actually *have* translated versions), a document `errordocs/403.shtml.lang` is created and filled with the error text in that language (see below).
- One fallback document called `errordocs/403.shtml` is created, usually by creating a symlink to the default language variant (see below).

The Common Header and Footer Files

By putting as much layout information in two special "include files", the error documents can be reduced to a bare minimum.

One of these layout files defines the HTML document header and a configurable list of paths to the icons to be shown in the resulting error document. These paths are exported as a set of SSI environment variables and are later evaluated by the "footer" special file. The title of the current error (which is put into the TITLE tag and an H1 header) is simply passed in from the main error document in a variable called `title`.

By changing this file, the layout of all generated error messages can be changed in a second. (By exploiting the features of SSI, you can easily define different layouts based on the current virtual host, or even based on the client's domain name).

The second layout file describes the footer to be displayed at the bottom of every error message. In this example, it shows an apache logo, the current server time, the server version string and adds a mail reference to the site's webmaster.

For simplicity, the header file is simply called `head.shtml` because it contains server-parsed content but no language specific information. The footer file exists once for each language translation, plus a symlink for the default language.

```
for English, French and German versions (default english)
foot.shtml.en,
foot.shtml.fr,
foot.shtml.de,
foot.shtml symlink to
foot.shtml.en
```

Both files are included into the error document by using the directives `<!--#include virtual="head" -->` and `<!--#include virtual="foot" -->` respectively: the rest of the magic occurs in `mod_negotiation` and in `mod_include`.

See the listings below to see an actual HTML implementation of the discussed example.

Creating ErrorDocuments in Different Languages

After all this preparation work, little remains to be said about the actual documents. They all share a simple common structure:

```
<!--#set var="title" value="error description title" -->
<!--#include virtual="head" -->
    explanatory error text
<!--#include virtual="foot" -->
```

In the listings section, you can see an example of a [400 Bad Request] error document. Documents as simple as that certainly cause no problems to translate or expand.

The Fallback Language

Do we need a special handling for languages other than those we have translations for? We did set the LanguagePriority, didn't we?!

Well, the LanguagePriority directive is for the case where the client does not express any language priority at all. But what happens in the situation where the client wants one of the languages we do not have, and none of those we do have?

Without doing anything, the Apache server will usually return a [406 no acceptable variant] error, listing the choices from which the client may select. But we're in an error message already, and important error information might get lost when the client had to choose a language representation first.

So, in this situation it appears to be easier to define a fallback language (by copying or linking, *e.g.*, the english version to a language-less version). Because the negotiation algorithm prefers "more specialized" variants over "more generic" variants, these generic alternatives will only be chosen when the normal negotiation did not succeed.

A simple shell script to do it (execute within the `errordocs/` dir):

```
for f in *.shtml.en
do
    ln -s $f `basename $f .en`
done
```

Customizing Proxy Error Messages

As of Apache-1.3, it is possible to use the `ErrorDocument` mechanism for proxy error messages as well (previous versions always returned fixed predefined error messages).

Most proxy errors return an error code of [500 Internal Server Error]. To find out whether a particular error document was invoked on behalf of a proxy error or because of some other server error, and what the reason for the failure was, you can check the contents of the new `ERROR_NOTES` CGI environment variable: if invoked for a proxy error, this variable will contain the actual proxy error message text in HTML form.

The following excerpt demonstrates how to exploit the `ERROR_NOTES` variable within an error document:

```
<!--#if expr="$REDIRECT_ERROR_NOTES = ''" -->
<p>
    The server encountered an unexpected condition
    which prevented it from fulfilling the request.
</p>
<p>
    <a href="mailto:<!--#echo var="SERVER_ADMIN" -->"
    SUBJECT="Error message [<!--#echo var="REDIRECT_STATUS" -->]
    <!--#echo var="title" --> for <!--#echo var="REQUEST_URI" -->">
    Please forward this error screen to <!--#echo var="SERVER_NAME"
    -->'s
    WebMaster</a>; it includes useful debugging information about
    the Request which caused the error.
    <pre><!--#printenv --></pre>
</p>
<!--#else -->
    <!--#echo var="REDIRECT_ERROR_NOTES" -->
<!--#endif -->
```

HTML Listing of the Discussed Example

So, to summarize our example, here's the complete listing of the `400.shtml.en` document. You will notice that it contains almost nothing but the error text (with conditional additions). Starting with this example, you will find it easy to add more error documents, or to translate the error documents to different languages.

```

<!--#set var="title" value="Bad Request"-->
<!--#include virtual="head" -->
<p>
  Your browser sent a request that this server could not understand:
  <blockquote>
    <strong><!--#echo var="REQUEST_URI" --></strong>
  </blockquote>
  The request could not be understood by the server due to malformed
  syntax. The client should not repeat the request without
  modifications.
</p>
<p>
  <!--#if expr="$HTTP_REFERER != ''" -->
    Please inform the owner of
    <a href="<!--#echo var="HTTP_REFERER" -->">the referring
    page</a> about
    the malformed link.
  <!--#else -->
    Please check your request for typing errors and retry.
  <!--#endif -->
</p>
<!--#include virtual="foot" -->

```

Here is the complete `head.shtml.en` file (the funny line breaks avoid empty lines in the document after SSI processing). Note the configuration section at top. That's where you configure the images and logos as well as the apache documentation directory. Look how this file displays two different logos depending on the content of the virtual host name (`$SERVER_NAME`), and that an animated apache logo is shown if the browser appears to support it (the latter requires server configuration lines of the form

```
BrowserMatch "^Mozilla/[2-4]" anigif
```

for browser types which support animated GIFs).

```

<!--#if expr="$SERVER_NAME = /*\mycompany\com/" -->
  <!--#set var="IMG_CorpLogo"
  value="http://$SERVER_NAME:$SERVER_PORT/errordocs/CorpLogo.gif"
  -->
  <!--#set var="ALT_CorpLogo" value="Powered by Linux!" -->
<!--#else -->
  <!--#set var="IMG_CorpLogo"
  value="http://$SERVER_NAME:$SERVER_PORT/errordocs/PrivLogo.gif"
  -->
  <!--#set var="ALT_CorpLogo" value="Powered by Linux!" -->
<!--#endif-->
<!--#set var="IMG_BgImage"
value="http://$SERVER_NAME:$SERVER_PORT/errordocs/BgImage.gif" -->
<!--#set var="DOC_Apache"
value="http://$SERVER_NAME:$SERVER_PORT/Apache/" -->
<!--#if expr="$anigif" -->
  <!--#set var="IMG_Apache"
  value="http://$SERVER_NAME:$SERVER_PORT/icons/apache_anim.gif" -->
<!--#else-->
  <!--#set var="IMG_Apache"
  value="http://$SERVER_NAME:$SERVER_PORT/icons/apache_pb.gif" -->
<!--#endif-->
<!DOCTYPE HTML PUBLIC "-//IETF//DTD HTML//EN">
<html>
<head>
  <title>
    [<!--#echo var="REDIRECT_STATUS" -->] <!--#echo var="title" -->
  </title>
</head>
<body bgcolor="white" background="<!--#echo var="IMG_BgImage" -->">
  <h1 align="center">
    [<!--#echo var="REDIRECT_STATUS" -->] <!--#echo var="title" -->
    "
    alt="<!--#echo var="ALT_CorpLogo" -->" align="right">
  </h1>
  <hr /> <!--
  ===== -->
  <div>

```

and this is the `foot.shtml.en` file:

```

</div>
<hr />
<div align="right">
  <small>Local Server time: <!--#echo var="DATE_LOCAL"
  --></small>
</div>
<div align="center">
  <a href="<!--#echo var="DOC_Apache" -->">
  " border="0"
  align="bottom"
  alt="Powered by <!--#echo var="SERVER_SOFTWARE" -->"></a>
  <br />
  <small><!--#set var="var" value="Powered by $SERVER_SOFTWARE
  --
  File last modified on $LAST_MODIFIED" -->
  <!--#echo var="var" --></small>
</div>
<p>If the indicated error looks like a misconfiguration, please
inform
<a href="mailto:<!--#echo var="SERVER_ADMIN" -->"
subject="Feedback about Error message [<!--#echo
var="REDIRECT_STATUS" -->]
<!--#echo var="title" -->, req=<!--#echo var="REQUEST_URI" -->">
<!--#echo var="SERVER_NAME" -->'s WebMaster</a>.
</p>
</body>
</html>

```

If you have tips to contribute, send mail to martin@apache.org¹

¹<mailto:martin@apache.org>

9.3 Connections in the FIN_WAIT_2 state and Apache



Warning:

This document has not been fully updated to take into account changes made in the 2.0 version of the Apache HTTP Server. Some of the information may still be relevant, but please use it with care.

Starting with the Apache 1.2 betas, people are reporting many more connections in the FIN_WAIT_2 state (as reported by `netstat`) than they saw using older versions. When the server closes a TCP connection, it sends a packet with the FIN bit set to the client, which then responds with a packet with the ACK bit set. The client then sends a packet with the FIN bit set to the server, which responds with an ACK and the connection is closed. The state that the connection is in during the period between when the server gets the ACK from the client and the server gets the FIN from the client is known as FIN_WAIT_2. See the TCP RFC (p. ??) for the technical details of the state transitions.

The FIN_WAIT_2 state is somewhat unusual in that there is no timeout defined in the standard for it. This means that on many operating systems, a connection in the FIN_WAIT_2 state will stay around until the system is rebooted. If the system does not have a timeout and too many FIN_WAIT_2 connections build up, it can fill up the space allocated for storing information about the connections and crash the kernel. The connections in FIN_WAIT_2 do not tie up an `httpd` process.

Why Does It Happen?

There are numerous reasons for it happening, some of them may not yet be fully clear. What is known follows.

Buggy Clients and Persistent Connections

Several clients have a bug which pops up when dealing with persistent connections (aka keepalives). When the connection is idle and the server closes the connection (based on the `KEEPALIVETIMEOUT`), the client is programmed so that the client does not send back a FIN and ACK to the server. This means that the connection stays in the FIN_WAIT_2 state until one of the following happens:

- The client opens a new connection to the same or a different site, which causes it to fully close the older connection on that socket.
- The user exits the client, which on some (most?) clients causes the OS to fully shutdown the connection.
- The FIN_WAIT_2 times out, on servers that have a timeout for this state.

If you are lucky, this means that the buggy client will fully close the connection and release the resources on your server. However, there are some cases where the socket is never fully closed, such as a dialup client disconnecting from their provider before closing the client. In addition, a client might sit idle for days without making another connection, and thus may hold its end of the socket open for days even though it has no further use for it. **This is a bug in the browser or in its operating system's TCP implementation.**

The clients on which this problem has been verified to exist:

- Mozilla/3.01 (X11; I; FreeBSD 2.1.5-RELEASE i386)
- Mozilla/2.02 (X11; I; FreeBSD 2.1.5-RELEASE i386)
- Mozilla/3.01Gold (X11; I; SunOS 5.5 sun4m)
- MSIE 3.01 on the Macintosh
- MSIE 3.01 on Windows 95

This does not appear to be a problem on:

- Mozilla/3.01 (Win95; I)

It is expected that many other clients have the same problem. What a client **should do** is periodically check its open socket(s) to see if they have been closed by the server, and close their side of the connection if the server has closed. This check need only occur once every few seconds, and may even be detected by a OS signal on some systems (*e.g.*, Win95 and NT clients have this capability, but they seem to be ignoring it).

Apache **cannot** avoid these FIN_WAIT_2 states unless it disables persistent connections for the buggy clients, just like we recommend doing for Navigator 2.x clients due to other bugs. However, non-persistent connections increase the total number of connections needed per client and slow retrieval of an image-laden web page. Since non-persistent connections have their own resource consumptions and a short waiting period after each closure, a busy server may need persistence in order to best serve its clients.

As far as we know, the client-caused FIN_WAIT_2 problem is present for all servers that support persistent connections, including Apache 1.1.x and 1.2.

A necessary bit of code introduced in 1.2

While the above bug is a problem, it is not the whole problem. Some users have observed no FIN_WAIT_2 problems with Apache 1.1.x, but with 1.2b enough connections build up in the FIN_WAIT_2 state to crash their server. The most likely source for additional FIN_WAIT_2 states is a function called `lingering_close()` which was added between 1.1 and 1.2. This function is necessary for the proper handling of persistent connections and any request which includes content in the message body (*e.g.*, PUTs and POSTs). What it does is read any data sent by the client for a certain time after the server closes the connection. The exact reasons for doing this are somewhat complicated, but involve what happens if the client is making a request at the same time the server sends a response and closes the connection. Without lingering, the client might be forced to reset its TCP input buffer before it has a chance to read the server's response, and thus understand why the connection has closed. See the appendix for more details.

The code in `lingering_close()` appears to cause problems for a number of factors, including the change in traffic patterns that it causes. The code has been thoroughly reviewed and we are not aware of any bugs in it. It is possible that there is some problem in the BSD TCP stack, aside from the lack of a timeout for the FIN_WAIT_2 state, exposed by the `lingering_close` code that causes the observed problems.

What Can I Do About it?

There are several possible workarounds to the problem, some of which work better than others.

Add a timeout for FIN_WAIT_2

The obvious workaround is to simply have a timeout for the FIN_WAIT_2 state. This is not specified by the RFC, and could be claimed to be a violation of the RFC, but it is widely recognized as being necessary. The following systems are known to have a timeout:

- FreeBSD² versions starting at 2.0 or possibly earlier.
- NetBSD³ version 1.2(?)
- OpenBSD⁴ all versions(?)

²<http://www.freebsd.org/>

³<http://www.netbsd.org/>

⁴<http://www.openbsd.org/>

- BSD/OS⁵ 2.1, with the K210-027 (p. ??) patch installed.
- Solaris⁶ as of around version 2.2. The timeout can be tuned by using `ndd` to modify `tcp_fin_wait_2_flush_interval`, but the default should be appropriate for most servers and improper tuning can have negative impacts.
- Linux⁷ 2.0.x and earlier(?)
- HP-UX⁸ 10.x defaults to terminating connections in the FIN_WAIT_2 state after the normal keepalive timeouts. This does not refer to the persistent connection or HTTP keepalive timeouts, but the `SO_LINGER` socket option which is enabled by Apache. This parameter can be adjusted by using `net tune` to modify parameters such as `tcp_keepstart` and `tcp_keepstop`. In later revisions, there is an explicit timer for connections in FIN_WAIT_2 that can be modified; contact HP support for details.
- SGI IRIX⁹ can be patched to support a timeout. For IRIX 5.3, 6.2, and 6.3, use patches 1654, 1703 and 1778 respectively. If you have trouble locating these patches, please contact your SGI support channel for help.
- NCR's MP RAS Unix¹⁰ 2.xx and 3.xx both have FIN_WAIT_2 timeouts. In 2.xx it is non-tunable at 600 seconds, while in 3.xx it defaults to 600 seconds and is calculated based on the tunable "max keep alive probes" (default of 8) multiplied by the "keep alive interval" (default 75 seconds).
- Sequent's ptx/TCP/IP for DYNIX/ptx¹¹ has had a FIN_WAIT_2 timeout since around release 4.1 in mid-1994.

The following systems are known to not have a timeout:

- SunOS 4.x¹² does not and almost certainly never will have one because it is at the very end of its development cycle for Sun. If you have kernel source should be easy to patch.

There is a patch available¹³ for adding a timeout to the FIN_WAIT_2 state; it was originally intended for BSD/OS, but should be adaptable to most systems using BSD networking code. You need kernel source code to be able to use it.

Compile without using `linger_close()`

It is possible to compile Apache 1.2 without using the `linger_close()` function. This will result in that section of code being similar to that which was in 1.1. If you do this, be aware that it can cause problems with PUTs, POSTs and persistent connections, especially if the client uses pipelining. That said, it is no worse than on 1.1, and we understand that keeping your server running is quite important.

To compile without the `linger_close()` function, add `-DNO_LINGCLOSE` to the end of the `EXTRA_CFLAGS` line in your Configuration file, rerun `Configure` and rebuild the server.

Use `SO_LINGER` as an alternative to `linger_close()`

On most systems, there is an option called `SO_LINGER` that can be set with `setsockopt(2)`. It does something very similar to `linger_close()`, except that it is broken on many systems so that it causes far more problems than `linger_close`. On some systems, it could possibly work better so it may be worth a try if you have no other alternatives.

⁵<http://www.bsdi.com/>

⁶<http://www.sun.com/>

⁷<http://www.linux.org/>

⁸<http://www.hp.com/>

⁹<http://www.sgi.com/>

¹⁰<http://www.ncr.com/>

¹¹<http://www.sequent.com>

¹²<http://www.sun.com/>

¹³http://www.apache.org/dist/httpd/contrib/patches/1.2/fin_wait_2.patch

To try it, add `-DUSE_SO_LINGER -DNO_LINGCLOSE` to the end of the `EXTRA_CFLAGS` line in your Configuration file, rerun `Configure` and rebuild the server.

⇒ NOTE

Attempting to use `SO_LINGER` and `linger_close()` at the same time is very likely to do very bad things, so don't.

Increase the amount of memory used for storing connection state

BSD based networking code: BSD stores network data, such as connection states, in something called an mbuf. When you get so many connections that the kernel does not have enough mbufs to put them all in, your kernel will likely crash. You can reduce the effects of the problem by increasing the number of mbufs that are available; this will not prevent the problem, it will just make the server go longer before crashing.

The exact way to increase them may depend on your OS; look for some reference to the number of "mbufs" or "mbuf clusters". On many systems, this can be done by adding the line `NMBCLUSTERS="n"`, where `n` is the number of mbuf clusters you want to your kernel config file and rebuilding your kernel.

Disable KeepAlive

If you are unable to do any of the above then you should, as a last resort, disable `KeepAlive`. Edit your `httpd.conf` and change "`KeepAlive On`" to "`KeepAlive Off`".

Appendix

Below is a message from Roy Fielding, one of the authors of HTTP/1.1.

Why the lingering close functionality is necessary with HTTP

The need for a server to linger on a socket after a close is noted a couple times in the HTTP specs, but not explained. This explanation is based on discussions between myself, Henrik Frystyk, Robert S. Thau, Dave Raggett, and John C. Mallery in the hallways of MIT while I was at W3C.

If a server closes the input side of the connection while the client is sending data (or is planning to send data), then the server's TCP stack will signal an RST (reset) back to the client. Upon receipt of the RST, the client will flush its own incoming TCP buffer back to the un-ACKed packet indicated by the RST packet argument. If the server has sent a message, usually an error response, to the client just before the close, and the client receives the RST packet before its application code has read the error message from its incoming TCP buffer and before the server has received the ACK sent by the client upon receipt of that buffer, then the RST will flush the error message before the client application has a chance to see it. The result is that the client is left thinking that the connection failed for no apparent reason.

There are two conditions under which this is likely to occur:

1. sending POST or PUT data without proper authorization
2. sending multiple requests before each response (pipelining) and one of the middle requests resulting in an error or other break-the-connection result.

The solution in all cases is to send the response, close only the write half of the connection (what shutdown is supposed to do), and continue reading on the socket until it is either closed by the client (signifying it has finally read the response) or a timeout occurs. That is what the kernel is supposed to do if `SO_LINGER` is set. Unfortunately, `SO_LINGER` has no effect on some systems; on some other systems, it does not have its own timeout and thus the TCP memory segments just pile-up until the next reboot (planned or not).

Please note that simply removing the linger code will not solve the problem – it only moves it to a different and much harder one to detect.

9.4 Known Problems in Clients



Warning:

This document has not been fully updated to take into account changes made in the 2.0 version of the Apache HTTP Server. Some of the information may still be relevant, but please use it with care.

Over time the Apache Group has discovered or been notified of problems with various clients which we have had to work around, or explain. This document describes these problems and the workarounds available. It's not arranged in any particular order. Some familiarity with the standards is assumed, but not necessary.

For brevity, *Navigator* will refer to Netscape's Navigator product (which in later versions was renamed "Communicator" and various other names), and *MSIE* will refer to Microsoft's Internet Explorer product. All trademarks and copyrights belong to their respective companies. We welcome input from the various client authors to correct inconsistencies in this paper, or to provide us with exact version numbers where things are broken/fixed.

For reference, RFC1945 (p. ??) defines HTTP/1.0, and RFC2068 (p. ??) defines HTTP/1.1. Apache as of version 1.2 is an HTTP/1.1 server (with an optional HTTP/1.0 proxy).

Various of these workarounds are triggered by environment variables. The admin typically controls which are set, and for which clients, by using `mod_browser`. Unless otherwise noted all of these workarounds exist in versions 1.2 and later.

Trailing CRLF on POSTs

This is a legacy issue. The CERN webserver required `POST` data to have an extra `CRLF` following it. Thus many clients send an extra `CRLF` that is not included in the `Content-Length` of the request. Apache works around this problem by eating any empty lines which appear before a request.

Broken KeepAlive

Various clients have had broken implementations of *keepalive* (persistent connections). In particular the Windows versions of Navigator 2.0 get very confused when the server times out an idle connection. The workaround is present in the default config files:

```
BrowserMatch Mozilla/2 nokeepalive
```

Note that this matches some earlier versions of MSIE, which began the practice of calling themselves *Mozilla* in their user-agent strings just like Navigator.

MSIE 4.0b2, which claims to support HTTP/1.1, does not properly support *keepalive* when it is used on 301 or 302 (redirect) responses. Unfortunately Apache's *nokeepalive* code prior to 1.2.2 would not work with HTTP/1.1 clients. You must apply this patch¹⁴ to version 1.2.1. Then add this to your config:

```
BrowserMatch "MSIE 4\.0b2;" nokeepalive
```

¹⁴http://www.apache.org/dist/httpd/patches/apply_to_1.2.1/msie_4_0b2_fixes.patch

Incorrect interpretation of HTTP/1.1 in response

To quote from section 3.1 of RFC1945:

⇒ HTTP uses a "<MAJOR>.<MINOR>" numbering scheme to indicate versions of the protocol. The protocol versioning policy is intended to allow the sender to indicate the format of a message and its capacity for understanding further HTTP communication, rather than the features obtained via that communication.

Since Apache is an HTTP/1.1 server, it indicates so as part of its response. Many client authors mistakenly treat this part of the response as an indication of the protocol that the response is in, and then refuse to accept the response.

The first major indication of this problem was with AOL's proxy servers. When Apache 1.2 went into beta it was the first wide-spread HTTP/1.1 server. After some discussion, AOL fixed their proxies. In anticipation of similar problems, the `force-response-1.0` environment variable was added to Apache. When present Apache will indicate "HTTP/1.0" in response to an HTTP/1.0 client, but will not in any other way change the response.

The pre-1.1 Java Development Kit (JDK) that is used in many clients (including Navigator 3.x and MSIE 3.x) exhibits this problem. As do some of the early pre-releases of the 1.1 JDK. We think it is fixed in the 1.1 JDK release. In any event the workaround:

```
BrowserMatch Java/1.0 force-response-1.0
BrowserMatch JDK/1.0 force-response-1.0
```

RealPlayer 4.0 from Progressive Networks also exhibits this problem. However they have fixed it in version 4.01 of the player, but version 4.01 uses the same `User-Agent` as version 4.0. The workaround is still:

```
BrowserMatch "RealPlayer 4.0" force-response-1.0
```

Requests use HTTP/1.1 but responses must be in HTTP/1.0

MSIE 4.0b2 has this problem. Its Java VM makes requests in HTTP/1.1 format but the responses must be in HTTP/1.0 format (in particular, it does not understand *chunked* responses). The workaround is to fool Apache into believing the request came in HTTP/1.0 format.

```
BrowserMatch "MSIE 4\.\0b2;" downgrade-1.0 force-response-1.0
```

This workaround is available in 1.2.2, and in a patch¹⁵ against 1.2.1.

Boundary problems with header parsing

All versions of Navigator from 2.0 through 4.0b2 (and possibly later) have a problem if the trailing CRLF of the response header starts at offset 256, 257 or 258 of the response. A `BrowserMatch` for this would match on nearly every hit, so the workaround is enabled automatically on all responses. The workaround implemented detects when this condition would occur in a response and adds extra padding to the header to push the trailing CRLF past offset 258 of the response.

¹⁵http://www.apache.org/dist/httpd/patches/apply_to.1.2.1/msie.4.0b2.fixes.patch

Multipart responses and Quoted Boundary Strings

On multipart responses some clients will not accept quotes (") around the boundary string. The MIME standard recommends that such quotes be used. But the clients were probably written based on one of the examples in RFC2068, which does not include quotes. Apache does not include quotes on its boundary strings to work around this problem.

byterange Requests

A byterange request is used when the client wishes to retrieve a portion of an object, not necessarily the entire object. There was a very old draft which included these byteranges in the URL. Old clients such as Navigator 2.0b1 and MSIE 3.0 for the MAC exhibit this behaviour, and it will appear in the servers' access logs as (failed) attempts to retrieve a URL with a trailing ";xxx-yyy". Apache does not attempt to implement this at all.

A subsequent draft of this standard defines a header `Request-Range`, and a response type `multipart/x-byteranges`. The HTTP/1.1 standard includes this draft with a few fixes, and it defines the header `Range` and type `multipart/byteranges`.

Navigator (versions 2 and 3) sends both `Range` and `Request-Range` headers (with the same value), but does not accept a `multipart/byteranges` response. The response must be `multipart/x-byteranges`. As a workaround, if Apache receives a `Request-Range` header it considers it "higher priority" than a `Range` header and in response uses `multipart/x-byteranges`.

The Adobe Acrobat Reader plugin makes extensive use of byteranges and prior to version 3.01 supports only the `multipart/x-byterange` response. Unfortunately there is no clue that it is the plugin making the request. If the plugin is used with Navigator, the above workaround works fine. But if the plugin is used with MSIE 3 (on Windows) the workaround won't work because MSIE 3 doesn't give the `Range-Request` clue that Navigator does. To work around this, Apache special cases "MSIE 3" in the `User-Agent` and serves `multipart/x-byteranges`. Note that the necessity for this with MSIE 3 is actually due to the Acrobat plugin, not due to the browser.

Netscape Communicator appears to not issue the non-standard `Request-Range` header. When an Acrobat plugin prior to version 3.01 is used with it, it will not properly understand byteranges. The user must upgrade their Acrobat reader to 3.01.

Set-Cookie header is unmergeable

The HTTP specifications say that it is legal to merge headers with duplicate names into one (separated by commas). Some browsers that support Cookies don't like merged headers and prefer that each `Set-Cookie` header is sent separately. When parsing the headers returned by a CGI, Apache will explicitly avoid merging any `Set-Cookie` headers.

Expires headers and GIF89A animations

Navigator versions 2 through 4 will erroneously re-request GIF89A animations on each loop of the animation if the first response included an `Expires` header. This happens regardless of how far in the future the expiry time is set. There is no workaround supplied with Apache, however there are hacks for 1.2¹⁶ and for 1.3¹⁷.

POST without Content-Length

In certain situations Navigator 3.01 through 3.03 appear to incorrectly issue a POST without the request body. There is no known workaround. It has been fixed in Navigator 3.04, Netscapes provides some information¹⁸. There's also

¹⁶<http://www.arctic.org/~dgaudet/patches/apache-1.2-gif89-expires-hack.patch>

¹⁷<http://www.arctic.org/~dgaudet/patches/apache-1.3-gif89-expires-hack.patch>

¹⁸<http://help.netscape.com/kb/client/971014-42.html>

some information¹⁹ about the actual problem.

JDK 1.2 betas lose parts of responses.

The http client in the JDK1.2beta2 and beta3 will throw away the first part of the response body when both the headers and the first part of the body are sent in the same network packet AND keep-alive's are being used. If either condition is not met then it works fine.

See also Bug-ID's 4124329 and 4125538 at the java developer connection.

If you are seeing this bug yourself, you can add the following BrowserMatch directive to work around it:

```
BrowserMatch "Java1\.2beta[23]" nokeepalive
```

We don't advocate this though since bending over backwards for beta software is usually not a good idea; ideally it gets fixed, new betas or a final release comes out, and no one uses the broken old software anymore. In theory.

Content-Type change is not noticed after reload

Navigator (all versions?) will cache the content-type for an object "forever". Using reload or shift-reload will not cause Navigator to notice a content-type change. The only work-around is for the user to flush their caches (memory and disk). By way of an example, some folks may be using an old mime.types file which does not map .htm to text/html, in this case Apache will default to sending text/plain. If the user requests the page and it is served as text/plain. After the admin fixes the server, the user will have to flush their caches before the object will be shown with the correct text/html type.

MSIE Cookie problem with expiry date in the year 2000

MSIE versions 3.00 and 3.02 (without the Y2K patch) do not handle cookie expiry dates in the year 2000 properly. Years after 2000 and before 2000 work fine. This is fixed in IE4.01 service pack 1, and in the Y2K patch for IE3.02. Users should avoid using expiry dates in the year 2000.

Lynx incorrectly asking for transparent content negotiation

The Lynx browser versions 2.7 and 2.8 send a "negotiate: trans" header in their requests, which is an indication the browser supports transparent content negotiation (TCN). However the browser does not support TCN. As of version 1.3.4, Apache supports TCN, and this causes problems with these versions of Lynx. As a workaround future versions of Apache will ignore this header when sent by the Lynx client.

MSIE 4.0 mishandles Vary response header

MSIE 4.0 does not handle a Vary header properly. The Vary header is generated by mod_rewrite in apache 1.3. The result is an error from MSIE saying it cannot download the requested file. There are more details in PR#4118²⁰.

A workaround is to add the following to your server's configuration files:

```
BrowserMatch "MSIE 4\.0" force-no-vary
```

¹⁹<http://www.arctic.org/~dgaudet/apache/no-content-length/>

²⁰<http://bugs.apache.org/index/full/4118>

(This workaround is only available with releases **after** 1.3.6 of the Apache Web server.)

9.5 Descriptors and Apache



Warning:

This document has not been fully updated to take into account changes made in the 2.0 version of the Apache HTTP Server. Some of the information may still be relevant, but please use it with care.

A *descriptor*, also commonly called a *file handle* is an object that a program uses to read or write an open file, or open network socket, or a variety of other devices. It is represented by an integer, and you may be familiar with `stdin`, `stdout`, and `stderr` which are descriptors 0, 1, and 2 respectively. Apache needs a descriptor for each log file, plus one for each network socket that it listens on, plus a handful of others. Libraries that Apache uses may also require descriptors. Normal programs don't open up many descriptors at all, and so there are some latent problems that you may experience should you start running Apache with many descriptors (*i.e.*, with many virtual hosts).

The operating system enforces a limit on the number of descriptors that a program can have open at a time. There are typically three limits involved here. One is a kernel limitation, depending on your operating system you will either be able to tune the number of descriptors available to higher numbers (this is frequently called *FD_SETSIZE*). Or you may be stuck with a (relatively) low amount. The second limit is called the *hard resource* limit, and it is sometimes set by root in an obscure operating system file, but frequently is the same as the kernel limit. The third limit is called the *soft resource* limit. The soft limit is always less than or equal to the hard limit. For example, the hard limit may be 1024, but the soft limit only 64. Any user can raise their soft limit up to the hard limit. Root can raise the hard limit up to the system maximum limit. The soft limit is the actual limit that is used when enforcing the maximum number of files a process can have open.

To summarize:

```
#open files <= soft limit <= hard limit <= kernel limit
```

You control the hard and soft limits using the `limit` (csh) or `ulimit` (sh) directives. See the respective man pages for more information. For example you can probably use `ulimit -n unlimited` to raise your soft limit up to the hard limit. You should include this command in a shell script which starts your webserver.

Unfortunately, it's not always this simple. As mentioned above, you will probably run into some system limitations that will need to be worked around somehow. Work was done in version 1.2.1 to improve the situation somewhat. Here is a partial list of systems and workarounds (assuming you are using 1.2.1 or later).

BSDI 2.0

Under BSDI 2.0 you can build Apache to support more descriptors by adding `-DFD_SETSIZE=nnn` to `EXTRA_CFLAGS` (where `nnn` is the number of descriptors you wish to support, keep it less than the hard limit). But it will run into trouble if more than approximately 240 `Listen` directives are used. This may be cured by rebuilding your kernel with a higher `FD_SETSIZE`.

FreeBSD 2.2, BSDI 2.1+

Similar to the BSDI 2.0 case, you should define `FD_SETSIZE` and rebuild. But the extra `Listen` limitation doesn't exist.

Linux

By default Linux has a kernel maximum of 256 open descriptors per process. There are several patches available for the 2.0.x series which raise this to 1024 and beyond, and you can find them in the "unofficial patches" section of the

Linux Information HQ²¹. None of these patches are perfect, and an entirely different approach is likely to be taken during the 2.1.x development. Applying these patches will raise the `FD_SETSIZE` used to compile all programs, and unless you rebuild all your libraries you should avoid running any other program with a soft descriptor limit above 256. As of this writing the patches available for increasing the number of descriptors do not take this into account. On a dedicated webserver you probably won't run into trouble.

Solaris through 2.5.1

Solaris has a kernel hard limit of 1024 (may be lower in earlier versions). But it has a limitation that files using the `stdio` library cannot have a descriptor above 255. Apache uses the `stdio` library for the `ErrorLog` directive. When you have more than approximately 110 virtual hosts (with an error log and an access log each) you will need to build Apache with `-DHIGH_SLACK_LINE=256` added to `EXTRA_CFLAGS`. You will be limited to approximately 240 error logs if you do this.

AIX

AIX version 3.2?? appears to have a hard limit of 128 descriptors. End of story. Version 4.1.5 has a hard limit of 2000.

SCO OpenServer

Edit the `/etc/conf/cf.d/stune` file or use `/etc/conf/cf.d/configure` choice 7 (User and Group configuration) and modify the `NOFILES` kernel parameter to a suitably higher value. SCO recommends a number between 60 and 11000, the default is 110. Relink and reboot, and the new number of descriptors will be available.

Compaq Tru64 UNIX/Digital UNIX/OSF

1. Raise `open_max_soft` and `open_max_hard` to 4096 in the `proc` subsystem. Do a man on `sysconfig`, `sysconfigdb`, and `sysconfigtab`.
2. Raise `max_vnodes` to a large number which is greater than the number of apache processes * 4096 (Setting it to 250,000 should be good for most people). Do a man on `sysconfig`, `sysconfigdb`, and `sysconfigtab`.
3. If you are using Tru64 5.0, 5.0A, or 5.1, define `NO_SLACK` to work around a bug in the OS.
`CFLAGS="-DNO_SLACK" ./configure`

Others

If you have details on another operating system, please submit it through our Bug Report Page²².

In addition to the problems described above there are problems with many libraries that Apache uses. The most common example is the `bind` DNS resolver library that is used by pretty much every unix, which fails if it ends up with a descriptor above 256. We suspect there are other libraries that similar limitations. So the code as of 1.2.1 takes a defensive stance and tries to save descriptors less than 16 for use while processing each request. This is called the *low slack line*.

Note that this shouldn't waste descriptors. If you really are pushing the limits and Apache can't get a descriptor above 16 when it wants it, it will settle for one below 16.

In extreme situations you may want to lower the low slack line, but you shouldn't ever need to. For example, lowering it can increase the limits 240 described above under Solaris and BSDI 2.0. But you'll play a delicate balancing game

²¹<http://www.linuxhq.com/>

²²http://httpd.apache.org/bug_report.html

with the descriptors needed to serve a request. Should you want to play this game, the compile time parameter is `LOW_SLACK_LINE` and there's a tiny bit of documentation in the header file `httpd.h`.

Finally, if you suspect that all this slack stuff is causing you problems, you can disable it. Add `-DNO_SLACK` to `EXTRA_CFLAGS` and rebuild. But please report it to our Bug Report Page²³ so that we can investigate.

²³http://httpd.apache.org/bug_report.html

9.6 Relevant Standards

This page documents all the relevant standards that the Apache HTTP Server follows, along with brief descriptions.

In addition to the information listed below, the following resources should be consulted:

- <http://purl.org/NET/http-errata>²⁴ - HTTP/1.1 Specification Errata
- <http://www.rfc-editor.org/errata.html>²⁵ - RFC Errata
- <http://ftp.ics.uci.edu/pub/ietf/http/#RFC>²⁶ - A pre-compiled list of HTTP related RFCs



Notice

This document is not yet complete.

HTTP Recommendations

Regardless of what modules are compiled and used, Apache as a basic web server complies with the following IETF recommendations:

RFC 1945²⁷ (Informational) The Hypertext Transfer Protocol (HTTP) is an application-level protocol with the lightness and speed necessary for distributed, collaborative, hypermedia information systems. This documents HTTP/1.0.

RFC 2616²⁸ (Standards Track) The Hypertext Transfer Protocol (HTTP) is an application-level protocol for distributed, collaborative, hypermedia information systems. This documents HTTP/1.1.

RFC 2396²⁹ (Standards Track) A Uniform Resource Identifier (URI) is a compact string of characters for identifying an abstract or physical resource.

HTML Recommendations

Regarding the Hypertext Markup Language, Apache complies with the following IETF and W3C recommendations:

RFC 2854³⁰ (Informational) This document summarizes the history of HTML development, and defines the "text/html" MIME type by pointing to the relevant W3C recommendations.

HTML 4.01 Specification³¹ (Errata³²) This specification defines the HyperText Markup Language (HTML), the publishing language of the World Wide Web. This specification defines HTML 4.01, which is a subversion of HTML 4.

HTML 3.2 Reference Specification³³ The HyperText Markup Language (HTML) is a simple markup language used to create hypertext documents that are portable from one platform to another. HTML documents are SGML documents.

XHTML 1.1 - Module-based XHTML³⁴ (Errata³⁵) This Recommendation defines a new XHTML document type that is based upon the module framework and modules defined in Modularization of XHTML.

XHTML 1.0 The Extensible HyperText Markup Language (Second Edition)³⁶ (Errata³⁷) This specification defines the Second Edition of XHTML 1.0, a reformulation of HTML 4 as an XML 1.0 application, and three DTDs corresponding to the ones defined by HTML 4.

²⁴<http://purl.org/NET/http-errata>

²⁵<http://www.rfc-editor.org/errata.html>

²⁶<http://ftp.ics.uci.edu/pub/ietf/http/#RFC>

Authentication

Concerning the different methods of authentication, Apache follows the following IETF recommendations:

RFC 2617³⁸ (**Draft standard**) "HTTP/1.0", includes the specification for a Basic Access Authentication scheme.

Language/Country Codes

The following links document ISO and other language and country code information:

ISO 639-2³⁹ ISO 639 provides two sets of language codes, one as a two-letter code set (639-1) and another as a three-letter code set (this part of ISO 639) for the representation of names of languages.

ISO 3166-1⁴⁰ These pages document the country names (official short names in English) in alphabetical order as given in ISO 3166-1 and the corresponding ISO 3166-1-alpha-2 code elements.

BCP 47⁴¹ (**Best Current Practice**), **RFC 3066**⁴² This document describes a language tag for use in cases where it is desired to indicate the language used in an information object, how to register values for use in this language tag, and a construct for matching such language tags.

RFC 3282⁴³ (**Standards Track**) This document defines a "Content-language:" header, for use in cases where one desires to indicate the language of something that has RFC 822-like headers, like MIME body parts or Web documents, and an "Accept-Language:" header for use in cases where one wishes to indicate one's preferences with regard to language.

Chapter 10

Apache modules

10.1 Terms Used to Describe Modules

This document describes the terms that are used to describe each Apache module (p. ??) .

Description

A brief description of the purpose of the module.

Status

This indicates how tightly bound into the Apache Web server the module is; in other words, you may need to recompile the server in order to gain access to the module and its functionality. Possible values for this attribute are:

MPM A module with status "MPM" is a Multi-Processing Module (p. 59) . Unlike the other types of modules, Apache must have one and only one MPM in use at any time. This type of module is responsible for basic request handling and dispatching.

Base A module labeled as having "Base" status is compiled and loaded into the server by default, and is therefore normally available unless you have taken steps to remove the module from your configuration.

Extension A module with "Extension" status is not normally compiled and loaded into the server. To enable the module and its functionality, you may need to change the server build configuration files and re-compile Apache.

Experimental "Experimental" status indicates that the module is available as part of the Apache kit, but you are on your own if you try to use it. The module is being documented for completeness, and is not necessarily supported.

External Modules which are not included with the base Apache distribution ("third-party modules") may use the "External" status. We are not responsible for, nor do we support such modules.

Source File

This quite simply lists the name of the source file which contains the code for the module. This is also the name used by the `<IfModule>` directive.

Module Identifier

This is a string which identifies the module for use in the `LoadModule` directive when dynamically loading modules. In particular, it is the name of the external variable of type module in the source file.

Compatibility

If the module was not part of the original Apache version 2 distribution, the version in which it was introduced should be listed here. In addition, if the module is limited to particular platforms, the details will be listed here.

10.2 Terms Used to Describe Directives

This document describes the terms that are used to describe each Apache configuration directive (p. 663).

See also

- Configuration files (p. 19)

Description

A brief description of the purpose of the directive.

Syntax

This indicates the format of the directive as it would appear in a configuration file. This syntax is extremely directive-specific, and is described in detail in the directive's definition. Generally, the directive name is followed by a series of one or more space-separated arguments. If an argument contains a space, the argument must be enclosed in double quotes. Optional arguments are enclosed in square brackets. Where an argument can take on more than one possible value, the possible values are separated by vertical bars "`—`". Literal text is presented in the default font, while argument-types for which substitution is necessary are *emphasized*. Directives which can take a variable number of arguments will end in "`...`" indicating that the last argument is repeated.

Directives use a great number of different argument types. A few common ones are defined below.

URL A complete Uniform Resource Locator including a scheme, hostname, and optional pathname as in `http://www.example.com/path/to/file.html`

URL-path The part of a *url* which follows the scheme and hostname as in `/path/to/file.html`. The *url-path* represents a web-view of a resource, as opposed to a file-system view.

file-path The path to a file in the local file-system beginning with the root directory as in `/usr/local/apache/htdocs/path/to/file.html`. Unless otherwise specified, a *file-path* which does not begin with a slash will be treated as relative to the `ServerRoot` (p. 302).

directory-path The path to a directory in the local file-system beginning with the root directory as in `/usr/local/apache/htdocs/path/to/`.

filename The name of a file with no accompanying path information as in `file.html`.

regex A Perl-compatible regular expression (p. 656). The directive definition will specify what the *regex* is matching against.

extension In general, this is the part of the *filename* which follows the last dot. However, Apache recognizes multiple filename extensions, so if a *filename* contains more than one dot, each dot-separated part of the filename following the first dot is an *extension*. For example, the *filename* `file.html.en` contains two extensions: `.html` and `.en`. For Apache directives, you may specify *extensions* with or without the leading dot. In addition, *extensions* are not case sensitive.

MIME-type A method of describing the format of a file which consists of a major format type and a minor format type, separated by a slash as in `text/html`.

env-variable The name of an environment variable (p. 60) defined in the Apache configuration process. Note this is not necessarily the same as an operating system environment variable. See the environment variable documentation (p. 60) for more details.

Default

If the directive has a default value (*i.e.*, if you omit it from your configuration entirely, the Apache Web server will behave as though you set it to a particular value), it is described here. If there is no default value, this section should say "None". Note that the default listed here is not necessarily the same as the value the directive takes in the default `httpd.conf` distributed with the server.

Context

This indicates where in the server's configuration files the directive is legal. It's a comma-separated list of one or more of the following values:

server config This means that the directive may be used in the server configuration files (*e.g.*, `httpd.conf`), but **not** within any `<VIRTUALHOST>` or `<DIRECTORY>` containers. It is not allowed in `.htaccess` files at all.

virtual host This context means that the directive may appear inside `<VIRTUALHOST>` containers in the server configuration files.

directory A directive marked as being valid in this context may be used inside `<DIRECTORY>`, `<LOCATION>`, and `<FILES>` containers in the server configuration files, subject to the restrictions outlined in How Directory, Location and Files sections work (p. 21).

.htaccess If a directive is valid in this context, it means that it can appear inside *per*-directory `.htaccess` files. It may not be processed, though depending upon the overrides currently active.

The directive is *only* allowed within the designated context; if you try to use it elsewhere, you'll get a configuration error that will either prevent the server from handling requests in that context correctly, or will keep the server from operating at all – *i.e.*, the server won't even start.

The valid locations for the directive are actually the result of a Boolean OR of all of the listed contexts. In other words, a directive that is marked as being valid in "server config, .htaccess" can be used in the `httpd.conf` file and in `.htaccess` files, but not within any `<DIRECTORY>` or `<VIRTUALHOST>` containers.

Override

This directive attribute indicates which configuration override must be active in order for the directive to be processed when it appears in a `.htaccess` file. If the directive's context doesn't permit it to appear in `.htaccess` files, then no context will be listed.

Overrides are activated by the `ALLOWOVERRIDE` directive, and apply to a particular scope (such as a directory) and all descendants, unless further modified by other `ALLOWOVERRIDE` directives at lower levels. The documentation for that directive also lists the possible override names available.

Status

This indicates how tightly bound into the Apache Web server the directive is; in other words, you may need to recompile the server with an enhanced set of modules in order to gain access to the directive and its functionality. Possible values for this attribute are:

Core If a directive is listed as having "Core" status, that means it is part of the innermost portions of the Apache Web server, and is always available.

MPM A directive labeled as having "MPM" status is provided by a Multi-Processing Module (p. 59) . This type of directive will be available if and only if you are using one of the MPMs listed on the Module line of the directive definition.

Base A directive labeled as having "Base" status is supported by one of the standard Apache modules which is compiled into the server by default, and is therefore normally available unless you've taken steps to remove the module from your configuration.

Extension A directive with "Extension" status is provided by one of the modules included with the Apache server kit, but the module isn't normally compiled into the server. To enable the directive and its functionality, you will need to change the server build configuration files and re-compile Apache.

Experimental "Experimental" status indicates that the directive is available as part of the Apache kit, but you're on your own if you try to use it. The directive is being documented for completeness, and is not necessarily supported. The module which provides the directive may or may not be compiled in by default; check the top of the page which describes the directive and its module to see if it remarks on the availability.

Module

This quite simply lists the name of the source module which defines the directive.

Compatibility

If the directive wasn't part of the original Apache version 2 distribution, the version in which it was introduced should be listed here. In addition, if the directive is available only on certain platforms, it will be noted here.

10.3 Apache Module core

Description: Core Apache HTTP Server features that are always available
Status: Core

Directives

- AcceptPathInfo
- AccessFileName
- AddDefaultCharset
- AddOutputFilterByType
- AllowEncodedSlashes
- AllowOverride
- AuthName
- AuthType
- CGIMapExtension
- ContentDigest
- DefaultType
- <Directory>
- <DirectoryMatch>
- DocumentRoot
- EnableMMAP
- EnableSendfile
- ErrorDocument
- ErrorLog
- FileETag
- <Files>
- <FilesMatch>
- ForceType
- HostnameLookups
- IdentityCheck
- <IfDefine>
- <IfModule>
- Include
- KeepAlive
- KeepAliveTimeout
- <Limit>
- <LimitExcept>
- LimitInternalRecursion
- LimitRequestBody
- LimitRequestFields
- LimitRequestFieldSize

- LimitRequestLine
- LimitXMLRequestBody
- <Location>
- <LocationMatch>
- LogLevel
- MaxKeepAliveRequests
- NameVirtualHost
- Options
- Require
- RLimitCPU
- RLimitMEM
- RLimitNPROC
- Satisfy
- ScriptInterpreterSource
- ServerAdmin
- ServerAlias
- ServerName
- ServerPath
- ServerRoot
- ServerSignature
- ServerTokens
- SetHandler
- SetInputFilter
- SetOutputFilter
- Timeout
- TraceEnable
- UseCanonicalName
- <VirtualHost>

AcceptPathInfo Directive

Description:	Resources accept trailing pathname information
Syntax:	AcceptPathInfo On Off Default
Default:	AcceptPathInfo Default
Context:	server config, virtual host, directory, .htaccess
Override:	FileInfo
Status:	Core
Module:	core
Compatibility:	Available in Apache 2.0.30 and later

This directive controls whether requests that contain trailing pathname information that follows an actual filename (or non-existent file in an existing directory) will be accepted or rejected. The trailing pathname information can be made available to scripts in the `PATH_INFO` environment variable.

For example, assume the location `/test/` points to a directory that contains only the single file `here.html`. Then requests for `/test/here.html/more` and `/test/nothere.html/more` both collect `/more` as `PATH_INFO`.

The three possible arguments for the `ACCEPTPATHINFO` directive are:

Off A request will only be accepted if it maps to a literal path that exists. Therefore a request with trailing pathname information after the true filename such as `/test/here.html/more` in the above example will return a 404 NOT FOUND error.

On A request will be accepted if a leading path component maps to a file that exists. The above example `/test/here.html/more` will be accepted if `/test/here.html` maps to a valid file.

Default The treatment of requests with trailing pathname information is determined by the handler (p. 65) responsible for the request. The core handler for normal files defaults to rejecting `PATH_INFO` requests. Handlers that serve scripts, such as `cgi-script` (p. 399) and `isapi-handler` (p. 461), generally accept `PATH_INFO` by default.

The primary purpose of the `AcceptPathInfo` directive is to allow you to override the handler's choice of accepting or rejecting `PATH_INFO`. This override is required, for example, when you use a filter (p. 67), such as `INCLUDES` (p. 450), to generate content based on `PATH_INFO`. The core handler would usually reject the request, so you can use the following configuration to enable such a script:

```
<Files "mypaths.shtml">
  Options +Includes
  SetOutputFilter INCLUDES
  AcceptPathInfo On
</Files>
```

AccessFileName Directive

Description:	Name of the distributed configuration file
Syntax:	<code>AccessFileName filename [filename] ...</code>
Default:	<code>AccessFileName .htaccess</code>
Context:	server config, virtual host
Status:	Core
Module:	core

While processing a request the server looks for the first existing configuration file from this list of names in every directory of the path to the document, if distributed configuration files are enabled for that directory. For example:

```
AccessFileName .acl
```

before returning the document `/usr/local/web/index.html`, the server will read `/.acl`, `/usr/.acl`, `/usr/local/.acl` and `/usr/local/web/.acl` for directives, unless they have been disabled with

```
<Directory />
  AllowOverride None
</Directory>
```

See also

- [ALLOWOVERRIDE](#)
- [Configuration Files](#) (p. 19)
- [.htaccess Files](#) (p. 197)

AddDefaultCharset Directive

Description:	Default charset parameter to be added when a response content-type is <code>text/plain</code> or <code>text/html</code>
Syntax:	<code>AddDefaultCharset On Off charset</code>
Default:	<code>AddDefaultCharset Off</code>
Context:	server config, virtual host, directory, <code>.htaccess</code>
Override:	<code>FileInfo</code>
Status:	Core
Module:	<code>core</code>

This directive specifies a default value for the media type charset parameter (the name of a character encoding) to be added to a response if and only if the response's content-type is either `text/plain` or `text/html`. This should override any charset specified in the body of the response via a `META` element, though the exact behavior is often dependent on the user's client configuration. A setting of `AddDefaultCharset Off` disables this functionality. `AddDefaultCharset On` enables a default charset of `iso-8859-1`. Any other value is assumed to be the charset to be used, which should be one of the IANA registered charset values¹ for use in MIME media types. For example:

```
AddDefaultCharset utf-8
```

ADDDFAULTCHARSET should only be used when all of the text resources to which it applies are known to be in that character encoding and it is too inconvenient to label their charset individually. One such example is to add the charset parameter to resources containing generated content, such as legacy CGI scripts, that might be vulnerable to cross-site scripting attacks due to user-provided data being included in the output. Note, however, that a better solution is to just fix (or delete) those scripts, since setting a default charset does not protect users that have enabled the "auto-detect character encoding" feature on their browser.

See also

- [ADDCHARSET](#)

AddOutputFilterByType Directive

Description:	assigns an output filter to a particular MIME-type
Syntax:	<code>AddOutputFilterByType filter[;filter...] MIME-type</code> <code>[MIME-type] ...</code>
Context:	server config, virtual host, directory, <code>.htaccess</code>
Override:	<code>FileInfo</code>
Status:	Core
Module:	<code>core</code>
Compatibility:	Available in Apache 2.0.33 and later

This directive activates a particular output filter (p. 67) for a request depending on the response MIME-type.

The following example uses the `DEFLATE` filter, which is provided by [MOD_DEFLATE](#). It will compress all output (either static or dynamic) which is labeled as `text/html` or `text/plain` before it is sent to the client.

```
AddOutputFilterByType DEFLATE text/html text/plain
```

If you want the content to be processed by more than one filter, their names have to be separated by semicolons. It's also possible to use one [ADDOUTPUTFILTERBYTYPE](#) directive for each of these filters.

¹<http://www.iana.org/assignments/character-sets>

The configuration below causes all script output labeled as `text/html` to be processed at first by the `INCLUDES` filter and then by the `DEFLATE` filter.

```
<Location /cgi-bin/>
  Options Includes
  AddOutputFilterByType INCLUDES;DEFLATE text/html
</Location>
```



Note

Enabling filters with `ADDOUTPUTFILTERBYTYPE` may fail partially or completely in some cases. For example, no filters are applied if the MIME-type could not be determined and falls back to the `DEFAULTTYPE` setting, even if the `DEFAULTTYPE` is the same.

However, if you want to make sure, that the filters will be applied, assign the content type to a resource explicitly, for example with `ADDTYPE` or `FORCETYPE`. Setting the content type within a (non-nph) CGI script is also safe.

The by-type output filters are never applied on proxy requests.

See also

- [ADDOUTPUTFILTER](#)
- [SETOUTPUTFILTER](#)
- filters (p. 67)

AllowEncodedSlashes Directive

Description:	Determines whether encoded path separators in URLs are allowed to be passed through
Syntax:	<code>AllowEncodedSlashes On Off</code>
Default:	<code>AllowEncodedSlashes Off</code>
Context:	server config, virtual host
Status:	Core
Module:	core
Compatibility:	Available in Apache 2.0.46 and later

The `ALLOWENCODEDSLASHES` directive allows URLs which contain encoded path separators (`%2F` for `/` and additionally `%5C` for `\` on according systems) to be used. Normally such URLs are refused with a 404 (Not found) error.

Turning `ALLOWENCODEDSLASHES` On is mostly useful when used in conjunction with `PATH-INFO`.

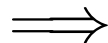

Note

Allowing encoded slashes does *not* imply *decoding*. Occurrences of `%2F` or `%5C` (*only* on according systems) will be left as such in the otherwise decoded URL string.

See also

- [ACCEPTPATHINFO](#)

AllowOverride Directive

Description:	Types of directives that are allowed in <code>.htaccess</code> files
Syntax:	<code>AllowOverride All None directive-type [directive-type] ...</code>
Default:	<code>AllowOverride All</code>
Context:	directory
Status:	Core
Module:	core

When the server finds an `.htaccess` file (as specified by [ACCESSFILENAME](#)) it needs to know which directives declared in that file can override earlier configuration directives.

⇒ Only available in `<Directory>` sections

[ALLOWOVERRIDE](#) is valid only in `<DIRECTORY>` sections specified without regular expressions, not in `<LOCATION>`, `<DIRECTORYMATCH>` or `<FILES>` sections.

When this directive is set to `None`, then `.htaccess` files are completely ignored. In this case, the server will not even attempt to read `.htaccess` files in the filesystem.

When this directive is set to `All`, then any directive which has the `.htaccess` Context (p. 299) is allowed in `.htaccess` files.

The directive-type can be one of the following groupings of directives.

AuthConfig Allow use of the authorization directives ([AUTHDBMGROUPFILE](#), [AUTHDBMUSERFILE](#), [AUTHGROUPFILE](#), [AUTHNAME](#), [AUTHTYPE](#), [AUTHUSERFILE](#), [REQUIRE](#), *etc.*).

FileInfo Allow use of the directives controlling document types ([DEFAULTTYPE](#), [ERRORDOCUMENT](#), [FORCETYPE](#), [LANGUAGEPRIORITY](#), [SETHANDLER](#), [SETINPUTFILTER](#), [SETOUTPUTFILTER](#), and [MOD_MIME](#) `Add*` and `Remove*` directives, *etc.*).

Indexes Allow use of the directives controlling directory indexing ([ADDDescription](#), [ADDICON](#), [ADDICONBYENCODING](#), [ADDICONBYTYPE](#), [DEFAULTICON](#), [DIRECTORYINDEX](#), [FANCYINDEXING](#), [HEADERNAME](#), [INDEXIGNORE](#), [INDEXOPTIONS](#), [READMENAME](#), *etc.*).

Limit Allow use of the directives controlling host access ([ALLOW](#), [DENY](#) and [ORDER](#)).

Options Allow use of the directives controlling specific directory features ([OPTIONS](#) and [XBITHACK](#)).

Example:

```
AllowOverride AuthConfig Indexes
```

In the example above all directives that are neither in the group `AuthConfig` nor `Indexes` cause an internal server error.

See also

- [ACCESSFILENAME](#)
- Configuration Files (p. 19)
- `.htaccess` Files (p. 197)

AuthName Directive

Description:	Authorization realm for use in HTTP authentication
Syntax:	<code>AuthName auth-domain</code>
Context:	directory, <code>.htaccess</code>
Override:	<code>AuthConfig</code>
Status:	Core
Module:	<code>core</code>

This directive sets the name of the authorization realm for a directory. This realm is given to the client so that the user knows which username and password to send. `AUTHNAME` takes a single argument; if the realm name contains spaces, it must be enclosed in quotation marks. It must be accompanied by `AUTHTYPE` and `REQUIRE` directives, and directives such as `AUTHUSERFILE` and `AUTHGROUPFILE` to work.

For example:

```
AuthName "Top Secret"
```

The string provided for the `AuthName` is what will appear in the password dialog provided by most browsers.

See also

- Authentication, Authorization, and Access Control (p. 181)

AuthType Directive

Description:	Type of user authentication
Syntax:	<code>AuthType Basic Digest</code>
Context:	directory, <code>.htaccess</code>
Override:	<code>AuthConfig</code>
Status:	Core
Module:	<code>core</code>

This directive selects the type of user authentication for a directory. Only `Basic` and `Digest` are currently implemented.

It must be accompanied by `AUTHNAME` and `REQUIRE` directives, and directives such as `AUTHUSERFILE` and `AUTHGROUPFILE` to work.

See also

- Authentication, Authorization, and Access Control (p. 181)

CGIMapExtension Directive

Description:	Technique for locating the interpreter for CGI scripts
Syntax:	<code>CGIMapExtension cgi-path .extension</code>
Context:	directory, <code>.htaccess</code>
Override:	<code>FileInfo</code>
Status:	Core
Module:	<code>core</code>
Compatibility:	NetWare only

This directive is used to control how Apache finds the interpreter used to run CGI scripts. For example, setting `CGIMapExtension sys:\foo.nlm .foo` will cause all CGI script files with a `.foo` extension to be passed to the FOO interpreter.

ContentDigest Directive

Description:	Enables the generation of <code>Content-MD5</code> HTTP Response headers
Syntax:	<code>ContentDigest On Off</code>
Default:	<code>ContentDigest Off</code>
Context:	server config, virtual host, directory, <code>.htaccess</code>
Override:	Options
Status:	Core
Module:	core

This directive enables the generation of `Content-MD5` headers as defined in RFC1864 respectively RFC2068.

MD5 is an algorithm for computing a "message digest" (sometimes called "fingerprint") of arbitrary-length data, with a high degree of confidence that any alterations in the data will be reflected in alterations in the message digest.

The `Content-MD5` header provides an end-to-end message integrity check (MIC) of the entity-body. A proxy or client may check this header for detecting accidental modification of the entity-body in transit. Example header:

```
Content-MD5: AuLb7Dp1rqtRtxz2m9kRpA==
```

Note that this can cause performance problems on your server since the message digest is computed on every request (the values are not cached).

`Content-MD5` is only sent for documents served by the [CORE](#), and not by any module. For example, SSI documents, output from CGI scripts, and byte range responses do not have this header.

DefaultType Directive

Description:	MIME content-type that will be sent if the server cannot determine a type in any other way
Syntax:	<code>DefaultType MIME-type</code>
Default:	<code>DefaultType text/plain</code>
Context:	server config, virtual host, directory, <code>.htaccess</code>
Override:	FileInfo
Status:	Core
Module:	core

There will be times when the server is asked to provide a document whose type cannot be determined by its MIME types mappings.

The server must inform the client of the content-type of the document, so in the event of an unknown type it uses the `DefaultType`. For example:

```
DefaultType image/gif
```

would be appropriate for a directory which contained many GIF images with filenames missing the `.gif` extension.

Note that unlike [FORCE_TYPE](#), this directive only provides the default mime-type. All other mime-type definitions, including filename extensions, that might identify the media type will override this default.

Directory Directive

Description:	Enclose a group of directives that apply only to the named file-system directory and sub-directories
Syntax:	<code><Directory directory-path> ... </Directory></code>
Context:	server config, virtual host
Status:	Core
Module:	core

`<DIRECTORY>` and `</Directory>` are used to enclose a group of directives that will apply only to the named directory and sub-directories of that directory. Any directive that is allowed in a directory context may be used. Directory-path is either the full path to a directory, or a wild-card string using Unix shell-style matching. In a wild-card string, `?` matches any single character, and `*` matches any sequences of characters. You may also use `[]` character ranges. None of the wildcards match a `'` character, so `<Directory */public.html>` will not match `/home/user/public.html`, but `<Directory /home/*/public.html>` will match. Example:

```
<Directory /usr/local/httpd/htdocs>
  Options Indexes FollowSymLinks
</Directory>
```

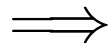

Be careful with the directory-path arguments: They have to literally match the filesystem path which Apache uses to access the files. Directives applied to a particular `<Directory>` will not apply to files accessed from that same directory via a different path, such as via different symbolic links.

Extended regular expressions can also be used, with the addition of the `~` character. For example:

```
<Directory ~ "^/www/.*/[0-9]{3}">
```

would match directories in `/www/` that consisted of three numbers.

If multiple (non-regular expression) `<DIRECTORY>` sections match the directory (or one of its parents) containing a document, then the directives are applied in the order of shortest match first, interspersed with the directives from the `.htaccess` files. For example, with

```
<Directory />
  AllowOverride None
</Directory>
<Directory /home/>
  AllowOverride FileInfo
</Directory>
```

for access to the document `/home/web/dir/doc.html` the steps are:

- Apply directive `AllowOverride None` (disabling `.htaccess` files).
- Apply directive `AllowOverride FileInfo` (for directory `/home`).
- Apply any `FileInfo` directives in `/home/.htaccess`, `/home/web/.htaccess` and `/home/web/dir/.htaccess` in that order.

Regular expressions are not considered until after all of the normal sections have been applied. Then all of the regular expressions are tested in the order they appeared in the configuration file. For example, with

```
<Directory ~ abc$>
  # ... directives here ...
</Directory>
```

the regular expression section won't be considered until after all normal `<DIRECTORY>`s and `.htaccess` files have been applied. Then the regular expression will match on `/home/abc/public.html/abc` and the corresponding `<DIRECTORY>` will be applied.

Note that the default Apache access for `<Directory />` is `Allow from All`. This means that Apache will serve any file mapped from an URL. It is recommended that you change this with a block such as

```
<Directory />
  Order Deny,Allow
  Deny from All
</Directory>
```

and then override this for directories you *want* accessible. See the Security Tips (p. 40) page for more details.

The directory sections occur in the `httpd.conf` file. `<DIRECTORY>` directives cannot nest, and cannot appear in a `<LIMIT>` or `<LIMITEXCEPT>` section.

See also

- How `<Directory>`, `<Location>` and `<Files>` sections work (p. 21) for an explanation of how these different sections are combined when a request is received

DirectoryMatch Directive

Description:	Enclose directives that apply to file-system directories matching a regular expression and their subdirectories
Syntax:	<code><DirectoryMatch regex> ... </DirectoryMatch></code>
Context:	server config, virtual host
Status:	Core
Module:	core

`<DIRECTORYMATCH>` and `</DirectoryMatch>` are used to enclose a group of directives which will apply only to the named directory and sub-directories of that directory, the same as `<DIRECTORY>`. However, it takes as an argument a regular expression. For example:

```
<DirectoryMatch "^/www/(.+)?[0-9]{3}">
```

would match directories in `/www/` that consisted of three numbers.

See also

- `<DIRECTORY>` for a description of how regular expressions are mixed in with normal `<DIRECTORY>`s
- How `<Directory>`, `<Location>` and `<Files>` sections work (p. 21) for an explanation of how these different sections are combined when a request is received

DocumentRoot Directive

Description:	Directory that forms the main document tree visible from the web
Syntax:	DocumentRoot directory-path
Default:	DocumentRoot /usr/local/apache/htdocs
Context:	server config, virtual host
Status:	Core
Module:	core

This directive sets the directory from which httpd will serve files. Unless matched by a directive like [ALIAS](#), the server appends the path from the requested URL to the document root to make the path to the document. Example:

```
DocumentRoot /usr/web
```

then an access to `http://www.my.host.com/index.html` refers to `/usr/web/index.html`.

The [DOCUMENTROOT](#) should be specified without a trailing slash.

See also

- [Mapping URLs to Filesystem Location](#) (p. 36)

EnableMMAP Directive

Description:	Use memory-mapping to read files during delivery
Syntax:	EnableMMAP On Off
Default:	EnableMMAP On
Context:	server config, virtual host, directory, .htaccess
Override:	FileInfo
Status:	Core
Module:	core

This directive controls whether the httpd may use memory-mapping if it needs to read the contents of a file during delivery. By default, when the handling of a request requires access to the data within a file – for example, when delivering a server-parsed file using [MOD_INCLUDE](#) – Apache memory-maps the file if the OS supports it.

This memory-mapping sometimes yields a performance improvement. But in some environments, it is better to disable the memory-mapping to prevent operational problems:

- On some multiprocessor systems, memory-mapping can reduce the performance of the httpd.
- With an NFS-mounted [DOCUMENTROOT](#), the httpd may crash due to a segmentation fault if a file is deleted or truncated while the httpd has it memory-mapped.

For server configurations that are vulnerable to these problems, you should disable memory-mapping of delivered files by specifying:

```
EnableMMAP Off
```

For NFS mounted files, this feature may be disabled explicitly for the offending files by specifying:

```
<Directory "/path-to-nfs-files">
  EnableMMAP Off
</Directory>
```

EnableSendfile Directive

Description:	Use the kernel sendfile support to deliver files to the client
Syntax:	<code>EnableSendfile On Off</code>
Default:	<code>EnableSendfile On</code>
Context:	server config, virtual host, directory, <code>.htaccess</code>
Override:	<code>FileInfo</code>
Status:	Core
Module:	core
Compatibility:	Available in version 2.0.44 and later

This directive controls whether httpd may use the sendfile support from the kernel to transmit file contents to the client. By default, when the handling of a request requires no access to the data within a file – for example, when delivering a static file – Apache uses sendfile to deliver the file contents without ever reading the file if the OS supports it.

This sendfile mechanism avoids separate read and send operations, and buffer allocations. But on some platforms or within some filesystems, it is better to disable this feature to avoid operational problems:

- Some platforms may have broken sendfile support that the build system did not detect, especially if the binaries were built on another box and moved to such a machine with broken sendfile support.
- On Linux the use of sendfile triggers TCP-checksum offloading bugs on certain networking cards when using IPv6.
- With a network-mounted `DOCUMENTROOT` (e.g., NFS or SMB), the kernel may be unable to serve the network file through its own cache.

For server configurations that are vulnerable to these problems, you should disable this feature by specifying:

```
EnableSendfile Off
```

For NFS or SMB mounted files, this feature may be disabled explicitly for the offending files by specifying:

```
<Directory "/path-to-nfs-files">
  EnableSendfile Off
</Directory>
```

ErrorDocument Directive

Description:	What the server will return to the client in case of an error
Syntax:	<code>ErrorDocument error-code document</code>
Context:	server config, virtual host, directory, <code>.htaccess</code>
Override:	<code>FileInfo</code>
Status:	Core
Module:	core
Compatibility:	Quoting syntax for text messages is different in Apache 2.0

In the event of a problem or error, Apache can be configured to do one of four things,

1. output a simple hardcoded error message
2. output a customized message
3. redirect to a local URL-path to handle the problem/error

4. redirect to an external URL to handle the problem/error

The first option is the default, while options 2-4 are configured using the `ERRORDOCUMENT` directive, which is followed by the HTTP response code and a URL or a message. Apache will sometimes offer additional information regarding the problem/error.

URLs can begin with a slash (/) for local web-paths (relative to the `DOCUMENTROOT`), or be a full URL which the client can resolve. Alternatively, a message can be provided to be displayed by the browser. Examples:

```
ErrorDocument 500 http://foo.example.com/cgi-bin/tester
ErrorDocument 404 /cgi-bin/bad_urls.pl
ErrorDocument 401 /subscription.info.html
ErrorDocument 403 "Sorry can't allow you access today"
```

Additionally, the special value `default` can be used to specify Apache's simple hardcoded message. While not required under normal circumstances, `default` will restore Apache's simple hardcoded message for configurations that would otherwise inherit an existing `ERRORDOCUMENT`.

```
ErrorDocument 404 /cgi-bin/bad_urls.pl
<Directory /web/docs>
    ErrorDocument 404 default
</Directory>
```

Note that when you specify an `ERRORDOCUMENT` that points to a remote URL (ie. anything with a method such as `http` in front of it), Apache will send a redirect to the client to tell it where to find the document, even if the document ends up being on the same server. This has several implications, the most important being that the client will not receive the original error status code, but instead will receive a redirect status code. This in turn can confuse web robots and other clients which try to determine if a URL is valid using the status code. In addition, if you use a remote URL in an `ErrorDocument 401`, the client will not know to prompt the user for a password since it will not receive the 401 status code. Therefore, **if you use an `ErrorDocument 401` directive then it must refer to a local document.**

Microsoft Internet Explorer (MSIE) will by default ignore server-generated error messages when they are "too small" and substitute its own "friendly" error messages. The size threshold varies depending on the type of error, but in general, if you make your error document greater than 512 bytes, then MSIE will show the server-generated error rather than masking it. More information is available in Microsoft Knowledge Base article Q294807².

Although most error messages can be overridden, there are certain circumstances where the internal messages are used regardless of the setting of `ERRORDOCUMENT`. In particular, if a malformed request is detected, normal request processing will be immediately halted and the internal error message returned. This is necessary to guard against security problems caused by bad requests.

Prior to version 2.0, messages were indicated by prefixing them with a single unmatched double quote character.

See also

- documentation of customizable responses (p. 54)

²<http://support.microsoft.com/default.aspx?scid=kb;en-us:Q294807>

ErrorLog Directive

Description:	Location where the server will log errors
Syntax:	<code>ErrorLog file-path syslog[:facility]</code>
Default:	<code>ErrorLog logs/error_log</code> (Unix) <code>ErrorLog logs/error.log</code> (Windows and OS/2)
Context:	server config, virtual host
Status:	Core
Module:	core

The [ERRORLOG](#) directive sets the name of the file to which the server will log any errors it encounters. If the file-path is not absolute then it is assumed to be relative to the [SERVERROOT](#).

Example

```
ErrorLog /var/log/httpd/error_log
```

If the file-path begins with a pipe (—) then it is assumed to be a command to spawn to handle the error log.

Example

```
ErrorLog "|/usr/local/bin/httpd_errors"
```

Using `syslog` instead of a filename enables logging via `syslogd(8)` if the system supports it. The default is to use `syslog` facility `local7`, but you can override this by using the `syslog:facility` syntax where `facility` can be one of the names usually documented in `syslog(1)`.

Example

```
ErrorLog syslog:user
```

SECURITY: See the security tips (p. 40) document for details on why your security could be compromised if the directory where log files are stored is writable by anyone other than the user that starts the server.



Note

When entering a file path on non-Unix platforms, care should be taken to make sure that only forward slashed are used even though the platform may allow the use of back slashes. In general it is a good idea to always use forward slashes throughout the configuration files.

See also

- [LOGLEVEL](#)
- [Apache Log Files](#) (p. 29)

FileETag Directive

Description:	File attributes used to create the ETag HTTP response header
Syntax:	<code>FileETag component ...</code>
Default:	<code>FileETag INode MTime Size</code>
Context:	server config, virtual host, directory, <code>.htaccess</code>
Override:	<code>FileInfo</code>
Status:	Core
Module:	core

The `FILEETAG` directive configures the file attributes that are used to create the `ETag` (entity tag) response header field when the document is based on a file. (The `ETag` value is used in cache management to save network bandwidth.) In Apache 1.3.22 and earlier, the `ETag` value was *always* formed from the file's inode, size, and last-modified time (mtime). The `FILEETAG` directive allows you to choose which of these – if any – should be used. The recognized keywords are:

INode The file's i-node number will be included in the calculation

MTime The date and time the file was last modified will be included

Size The number of bytes in the file will be included

All All available fields will be used. This is equivalent to:

```
FileETag INode MTime Size
```

None If a document is file-based, no `ETag` field will be included in the response

The `INode`, `MTime`, and `Size` keywords may be prefixed with either `+` or `-`, which allow changes to be made to the default setting inherited from a broader scope. Any keyword appearing without such a prefix immediately and completely cancels the inherited setting.

If a directory's configuration includes `FileETagINodeMTimeSize`, and a subdirectory's includes `FileETag-INode`, the setting for that subdirectory (which will be inherited by any sub-subdirectories that don't override it) will be equivalent to `FileETagMTimeSize`.

Files Directive

Description:	Contains directives that apply to matched filenames
Syntax:	<code><Files filename> ... </Files></code>
Context:	server config, virtual host, directory, <code>.htaccess</code>
Override:	All
Status:	Core
Module:	core

The `<FILES>` directive limits the scope of the enclosed directives by filename. It is comparable to the `<DIRECTORY>` and `<LOCATION>` directives. It should be matched with a `</Files>` directive. The directives given within this section will be applied to any object with a basename (last component of filename) matching the specified filename. `<FILES>` sections are processed in the order they appear in the configuration file, after the `<DIRECTORY>` sections and `.htaccess` files are read, but before `<LOCATION>` sections. Note that `<FILES>` can be nested inside `<DIRECTORY>` sections to restrict the portion of the filesystem they apply to.

The filename argument should include a filename, or a wild-card string, where `?` matches any single character, and `*` matches any sequences of characters. Extended regular expressions can also be used, with the addition of the `~` character. For example:

```
<Files ~ "\.(gif|jpe?g|png)$">
```

would match most common Internet graphics formats. `<FILESMATCH>` is preferred, however.

Note that unlike `<DIRECTORY>` and `<LOCATION>` sections, `<FILES>` sections can be used inside `.htaccess` files. This allows users to control access to their own files, at a file-by-file level.

See also

- How `<Directory>`, `<Location>` and `<Files>` sections work (p. 21) for an explanation of how these different sections are combined when a request is received

FilesMatch Directive

Description:	Contains directives that apply to regular-expression matched filenames
Syntax:	<code><FilesMatch regex> ... </FilesMatch></code>
Context:	server config, virtual host, directory, .htaccess
Override:	All
Status:	Core
Module:	core

The `<FILESMATCH>` directive limits the scope of the enclosed directives by filename, just as the `<FILES>` directive does. However, it accepts a regular expression. For example:

```
<FilesMatch "\.(gif|jpe?g|png)$">
```

would match most common Internet graphics formats.

See also

- How `<Directory>`, `<Location>` and `<Files>` sections work (p. 21) for an explanation of how these different sections are combined when a request is received

ForceType Directive

Description:	Forces all matching files to be served with the specified MIME content-type
Syntax:	<code>ForceType MIME-type None</code>
Context:	directory, .htaccess
Override:	FileInfo
Status:	Core
Module:	core
Compatibility:	Moved to the core in Apache 2.0

When placed into an `.htaccess` file or a `<DIRECTORY>`, or `<LOCATION>` or `<FILES>` section, this directive forces all matching files to be served with the content type identification given by MIME-type. For example, if you had a directory full of GIF files, but did not want to label them all with `.gif`, you might want to use:

```
ForceType image/gif
```

Note that unlike `DEFAULTTYPE`, this directive overrides all mime-type associations, including filename extensions, that might identify the media type.

You can override any `FORCETYPE` setting by using the value of `None`:

```
# force all files to be image/gif:
<Location /images>
    ForceType image/gif
</Location>

# but normal mime-type associations here:
<Location /images/mixed>
    ForceType None
</Location>
```

HostnameLookups Directive

Description:	Enables DNS lookups on client IP addresses
Syntax:	HostnameLookups On Off Double
Default:	HostnameLookups Off
Context:	server config, virtual host, directory
Status:	Core
Module:	core

This directive enables DNS lookups so that host names can be logged (and passed to CGIs/SSIs in `REMOTE_HOST`). The value `Double` refers to doing double-reverse DNS lookup. That is, after a reverse lookup is performed, a forward lookup is then performed on that result. At least one of the IP addresses in the forward lookup must match the original address. (In "tcpwrappers" terminology this is called `PARANOID`.)

Regardless of the setting, when `MOD_ACCESS` is used for controlling access by hostname, a double reverse lookup will be performed. This is necessary for security. Note that the result of this double-reverse isn't generally available unless you set `HostnameLookups Double`. For example, if only `HostnameLookups On` and a request is made to an object that is protected by hostname restrictions, regardless of whether the double-reverse fails or not, CGIs will still be passed the single-reverse result in `REMOTE_HOST`.

The default is `Off` in order to save the network traffic for those sites that don't truly need the reverse lookups done. It is also better for the end users because they don't have to suffer the extra latency that a lookup entails. Heavily loaded sites should leave this directive `Off`, since DNS lookups can take considerable amounts of time. The utility `logresolve`, compiled by default to the `bin` subdirectory of your installation directory, can be used to look up host names from logged IP addresses offline.

IdentityCheck Directive

Description:	Enables logging of the RFC1413 identity of the remote user
Syntax:	IdentityCheck On Off
Default:	IdentityCheck Off
Context:	server config, virtual host, directory
Status:	Core
Module:	core

This directive enables RFC1413-compliant logging of the remote user name for each connection, where the client machine runs `identd` or something similar. This information is logged in the access log.

The information should not be trusted in any way except for rudimentary usage tracking.

Note that this can cause serious latency problems accessing your server since every request requires one of these lookups to be performed. When firewalls are involved each lookup might possibly fail and add 30 seconds of latency to each hit. So in general this is not very useful on public servers accessible from the Internet.

IfDefine Directive

Description:	Encloses directives that will be processed only if a test is true at startup
Syntax:	<IfDefine [!]parameter-name> ... </IfDefine>
Context:	server config, virtual host, directory, <code>.htaccess</code>
Override:	All
Status:	Core
Module:	core

The `<IfDefine test>...</IfDefine>` section is used to mark directives that are conditional. The directives within an `<IFDEFINE>` section are only processed if the test is true. If test is false, everything between the start and end markers is ignored.

The test in the `<IFDEFINE>` section directive can be one of two forms:

- parameter-name
- !parameter-name

In the former case, the directives between the start and end markers are only processed if the parameter named parameter-name is defined. The second format reverses the test, and only processes the directives if parameter-name is **not** defined.

The parameter-name argument is a define as given on the httpd command line via `-Dparameter-`, at the time the server was started.

`<IFDEFINE>` sections are nest-able, which can be used to implement simple multiple-parameter tests. Example:

```
httpd -DReverseProxy ...
# httpd.conf
<IfDefine ReverseProxy>
    LoadModule rewrite_module modules/mod_rewrite.so
    LoadModule proxy_module modules/libproxy.so
</IfDefine>
```

IfModule Directive

Description:	Encloses directives that are processed conditional on the presence or absence of a specific module
Syntax:	<code><IfModule [!]module-name> ... </IfModule></code>
Context:	server config, virtual host, directory, .htaccess
Override:	All
Status:	Core
Module:	core

The `<IfModule test>...</IfModule>` section is used to mark directives that are conditional on the presence of a specific module. The directives within an `<IFMODULE>` section are only processed if the test is true. If test is false, everything between the start and end markers is ignored.

The test in the `<IFMODULE>` section directive can be one of two forms:

- module name
- !module name

In the former case, the directives between the start and end markers are only processed if the module named module name is included in Apache – either compiled in or dynamically loaded using `LOADMODULE`. The second format reverses the test, and only processes the directives if module name is **not** included.

The module name argument is the file name of the module, at the time it was compiled. For example, `mod_rewrite.c`. If a module consists of several source files, use the name of the file containing the string `STANDARD20_MODULE_STUFF`.

`<IFMODULE>` sections are nest-able, which can be used to implement simple multiple-module tests.

⇒ This section should only be used if you need to have one configuration file that works whether or not a specific module is available. In normal operation, directives need not be placed in `<IFMODULE>` sections.

Include Directive

Description:	Includes other configuration files from within the server configuration files
Syntax:	<code>Include file-path directory-path</code>
Context:	server config, virtual host, directory
Status:	Core
Module:	core
Compatibility:	Wildcard matching available in 2.0.41 and later

This directive allows inclusion of other configuration files from within the server configuration files.

Shell-style (`fnmatch()`) wildcard characters can be used to include several files at once, in alphabetical order. In addition, if **INCLUDE** points to a directory, rather than a file, Apache will read all files in that directory and any subdirectory. But including entire directories is not recommended, because it is easy to accidentally leave temporary files in a directory that can cause httpd to fail.

The file path specified may be an absolute path, or may be relative to the **SERVERROOT** directory.

Examples:

```
Include /usr/local/apache2/conf/ssl.conf
Include /usr/local/apache2/conf/vhosts/*.conf
```

Or, providing paths relative to your **SERVERROOT** directory:

```
Include conf/ssl.conf
Include conf/vhosts/*.conf
```

Running `apachectl configtest` will give you a list of the files that are being processed during the configuration check:

```
root@host# apachectl configtest
Processing config file: /usr/local/apache2/conf/ssl.conf
Processing config file: /usr/local/apache2/conf/vhosts/vhost1.conf
Processing config file: /usr/local/apache2/conf/vhosts/vhost2.conf
Syntax OK
```

See also

- `apachectl`

KeepAlive Directive

Description:	Enables HTTP persistent connections
Syntax:	<code>KeepAlive On Off</code>
Default:	<code>KeepAlive On</code>
Context:	server config, virtual host
Status:	Core
Module:	core

The Keep-Alive extension to HTTP/1.0 and the persistent connection feature of HTTP/1.1 provide long-lived HTTP sessions which allow multiple requests to be sent over the same TCP connection. In some cases this has been shown to result in an almost 50% speedup in latency times for HTML documents with many images. To enable Keep-Alive connections, set `KeepAlive On`.

For HTTP/1.0 clients, Keep-Alive connections will only be used if they are specifically requested by a client. In addition, a Keep-Alive connection with an HTTP/1.0 client can only be used when the length of the content is known in advance. This implies that dynamic content such as CGI output, SSI pages, and server-generated directory listings will generally not use Keep-Alive connections to HTTP/1.0 clients. For HTTP/1.1 clients, persistent connections are the default unless otherwise specified. If the client requests it, chunked encoding will be used in order to send content of unknown length over persistent connections.

See also

- [MAXKEEPALIVEREQUESTS](#)

KeepAliveTimeout Directive

Description:	Amount of time the server will wait for subsequent requests on a persistent connection
Syntax:	KeepAliveTimeout seconds
Default:	KeepAliveTimeout 15
Context:	server config, virtual host
Status:	Core
Module:	core

The number of seconds Apache will wait for a subsequent request before closing the connection. Once a request has been received, the timeout value specified by the [TIMEOUT](#) directive applies.

Setting [KEEPALIVETIMEOUT](#) to a high value may cause performance problems in heavily loaded servers. The higher the timeout, the more server processes will be kept occupied waiting on connections with idle clients.

Limit Directive

Description:	Restrict enclosed access controls to only certain HTTP methods
Syntax:	<Limit method [method] ... > ... </Limit>
Context:	server config, virtual host, directory, .htaccess
Override:	All
Status:	Core
Module:	core

Access controls are normally effective for **all** access methods, and this is the usual desired behavior. **In the general case, access control directives should not be placed within a <LIMIT> section.**

The purpose of the <LIMIT> directive is to restrict the effect of the access controls to the nominated HTTP methods. For all other methods, the access restrictions that are enclosed in the <LIMIT> bracket **will have no effect**. The following example applies the access control only to the methods POST, PUT, and DELETE, leaving all other methods unprotected:

```

<Limit POST PUT DELETE>
    Require valid-user
</Limit>
```

The method names listed can be one or more of: GET, POST, PUT, DELETE, CONNECT, OPTIONS, PATCH, PROPFIND, PROPPATCH, MKCOL, COPY, MOVE, LOCK, and UNLOCK. **The method name is case-sensitive.** If GET is used it will also restrict HEAD requests. The TRACE method cannot be limited.



A <LIMITEXCEPT> section should always be used in preference to a <LIMIT> section when restricting access, since a <LIMITEXCEPT> section provides protection against arbitrary methods.

LimitExcept Directive

Description:	Restrict access controls to all HTTP methods except the named ones
Syntax:	<code><LimitExcept method [method] ... > ... </LimitExcept></code>
Context:	server config, virtual host, directory, .htaccess
Override:	All
Status:	Core
Module:	core

`<LIMITEXCEPT>` and `</LimitExcept>` are used to enclose a group of access control directives which will then apply to any HTTP access method **not** listed in the arguments; i.e., it is the opposite of a `<LIMIT>` section and can be used to control both standard and nonstandard/unrecognized methods. See the documentation for `<LIMIT>` for more details.

For example:

```

<LimitExcept POST GET>
    Require valid-user
</LimitExcept>
```

LimitInternalRecursion Directive

Description:	Determine maximum number of internal redirects and nested subrequests
Syntax:	<code>LimitInternalRecursion number [number]</code>
Default:	<code>LimitInternalRecursion 10</code>
Context:	server config, virtual host
Status:	Core
Module:	core
Compatibility:	Available in Apache 2.0.47 and later

An internal redirect happens, for example, when using the `ACTION` directive, which internally redirects the original request to a CGI script. A subrequest is Apache's mechanism to find out what would happen for some URI if it were requested. For example, `MOD_DIR` uses subrequests to look for the files listed in the `DIRECTORYINDEX` directive.

`LIMITINTERNALRECURSION` prevents the server from crashing when entering an infinite loop of internal redirects or subrequests. Such loops are usually caused by misconfigurations.

The directive stores two different limits, which are evaluated on per-request basis. The first number is the maximum number of internal redirects, that may follow each other. The second number determines, how deep subrequests may be nested. If you specify only one number, it will be assigned to both limits.

```

Example
LimitInternalRecursion 5
```

LimitRequestBody Directive

Description:	Restricts the total size of the HTTP request body sent from the client
Syntax:	<code>LimitRequestBody bytes</code>
Default:	<code>LimitRequestBody 0</code>
Context:	server config, virtual host, directory, .htaccess
Override:	All
Status:	Core
Module:	core

This directive specifies the number of bytes from 0 (meaning unlimited) to 2147483647 (2GB) that are allowed in a request body.

The **LIMITREQUESTBODY** directive allows the user to set a limit on the allowed size of an HTTP request message body within the context in which the directive is given (server, per-directory, per-file or per-location). If the client request exceeds that limit, the server will return an error response instead of servicing the request. The size of a normal request message body will vary greatly depending on the nature of the resource and the methods allowed on that resource. CGI scripts typically use the message body for retrieving form information. Implementations of the **PUT** method will require a value at least as large as any representation that the server wishes to accept for that resource.

This directive gives the server administrator greater control over abnormal client request behavior, which may be useful for avoiding some forms of denial-of-service attacks.

If, for example, you are permitting file upload to a particular location, and wish to limit the size of the uploaded file to 100K, you might use the following directive:

```
LimitRequestBody 102400
```

LimitRequestFields Directive

Description:	Limits the number of HTTP request header fields that will be accepted from the client
Syntax:	LimitRequestFields number
Default:	LimitRequestFields 100
Context:	server config
Status:	Core
Module:	core

Number is an integer from 0 (meaning unlimited) to 32767. The default value is defined by the compile-time constant `DEFAULT_LIMIT_REQUEST_FIELDS` (100 as distributed).

The **LIMITREQUESTFIELDS** directive allows the server administrator to modify the limit on the number of request header fields allowed in an HTTP request. A server needs this value to be larger than the number of fields that a normal client request might include. The number of request header fields used by a client rarely exceeds 20, but this may vary among different client implementations, often depending upon the extent to which a user has configured their browser to support detailed content negotiation. Optional HTTP extensions are often expressed using request header fields.

This directive gives the server administrator greater control over abnormal client request behavior, which may be useful for avoiding some forms of denial-of-service attacks. The value should be increased if normal clients see an error response from the server that indicates too many fields were sent in the request.

For example:

```
LimitRequestFields 50
```

LimitRequestFieldSize Directive

Description:	Limits the size of the HTTP request header allowed from the client
Syntax:	LimitRequestFieldsize bytes
Default:	LimitRequestFieldsize 8190
Context:	server config
Status:	Core
Module:	core

This directive specifies the number of bytes that will be allowed in an HTTP request header.

The **LIMITREQUESTFIELDSize** directive allows the server administrator to reduce or increase the limit on the allowed size of an HTTP request header field. A server needs this value to be large enough to hold any one header field from a normal client request. The size of a normal request header field will vary greatly among different client implementations, often depending upon the extent to which a user has configured their browser to support detailed content negotiation. SPNEGO authentication headers can be up to 12392 bytes.

This directive gives the server administrator greater control over abnormal client request behavior, which may be useful for avoiding some forms of denial-of-service attacks.

For example:

```
LimitRequestFieldSize 4094
```

⇒ Under normal conditions, the value should not be changed from the default.

⇒ Apache 2.0.53 or higher is required for increasing the limit above the compiled-in value of `DEFAULT_LIMIT_REQUEST_FIELD_SIZE` (8190 as distributed).

LimitRequestLine Directive

Description:	Limit the size of the HTTP request line that will be accepted from the client
Syntax:	<code>LimitRequestLine bytes</code>
Default:	<code>LimitRequestLine 8190</code>
Context:	server config
Status:	Core
Module:	core

This directive sets the number of bytes from 0 to the value of the compile-time constant `DEFAULT_LIMIT_REQUEST_LINE` (8190 as distributed) that will be allowed on the HTTP request-line.

The **LIMITREQUESTLINE** directive allows the server administrator to reduce the limit on the allowed size of a client's HTTP request-line below the normal input buffer size compiled with the server. Since the request-line consists of the HTTP method, URI, and protocol version, the **LIMITREQUESTLINE** directive places a restriction on the length of a request-URI allowed for a request on the server. A server needs this value to be large enough to hold any of its resource names, including any information that might be passed in the query part of a GET request.

This directive gives the server administrator greater control over abnormal client request behavior, which may be useful for avoiding some forms of denial-of-service attacks.

For example:

```
LimitRequestLine 4094
```

⇒ Under normal conditions, the value should not be changed from the default.

LimitXMLRequestBody Directive

Description:	Limits the size of an XML-based request body
Syntax:	<code>LimitXMLRequestBody bytes</code>
Default:	<code>LimitXMLRequestBody 1000000</code>
Context:	server config, virtual host, directory, <code>.htaccess</code>
Override:	All
Status:	Core
Module:	core

Limit (in bytes) on maximum size of an XML-based request body. A value of 0 will disable any checking.

Example:

```
LimitXMLRequestBody 0
```

Location Directive

Description:	Applies the enclosed directives only to matching URLs
Syntax:	<Location URL-path URL> ... </Location>
Context:	server config, virtual host
Status:	Core
Module:	core

The <LOCATION> directive limits the scope of the enclosed directives by URL. It is similar to the <DIRECTORY> directive, and starts a subsection which is terminated with a </Location> directive. <LOCATION> sections are processed in the order they appear in the configuration file, after the <DIRECTORY> sections and .htaccess files are read, and after the <FILES> sections.

<LOCATION> sections operate completely outside the filesystem. This has several consequences. Most importantly, <LOCATION> directives should not be used to control access to filesystem locations. Since several different URLs may map to the same filesystem location, such access controls may be circumvented.

⇒ When to use <LOCATION>

Use <LOCATION> to apply directives to content that lives outside the filesystem. For content that lives in the filesystem, use <DIRECTORY> and <FILES>. An exception is <Location />, which is an easy way to apply a configuration to the entire server.

For all origin (non-proxy) requests, the URL to be matched is a URL-path of the form /path/. No scheme, hostname, port, or query string may be included. For proxy requests, the URL to be matched is of the form scheme://servername/path, and you must include the prefix.

The URL may use wildcards. In a wild-card string, ? matches any single character, and * matches any sequences of characters.

Extended regular expressions can also be used, with the addition of the ~ character. For example:

```
<Location ~ "/(extra|special)/data">
```

would match URLs that contained the substring /extra/data or /special/data. The directive <LOCATION-MATCH> behaves identical to the regex version of <LOCATION>.

The <LOCATION> functionality is especially useful when combined with the <SETHANDLER> directive. For example, to enable status requests, but allow them only from browsers at foo.com, you might use:

```
<Location /status>
  SetHandler server-status
  Order Deny,Allow
  Deny from all
  Allow from .foo.com
</Location>
```

⇒ Note about / (slash)

The slash character has special meaning depending on where in a URL it appears. People may be used to its behavior in the filesystem where multiple adjacent slashes are frequently collapsed to a single slash (*i.e.*, `/home///foo` is the same as `/home/foo`). In URL-space this is not necessarily true. The `<LOCATIONMATCH>` directive and the regex version of `<LOCATION>` require you to explicitly specify multiple slashes if that is your intention.

For example, `<LocationMatch ^/abc>` would match the request URL `/abc` but not the request URL `//abc`. The (non-regex) `<LOCATION>` directive behaves similarly when used for proxy requests. But when (non-regex) `<LOCATION>` is used for non-proxy requests it will implicitly match multiple slashes with a single slash. For example, if you specify `<Location /abc/def>` and the request is to `/abc//def` then it will match.

See also

- How `<Directory>`, `<Location>` and `<Files>` sections work (p. 21) for an explanation of how these different sections are combined when a request is received

LocationMatch Directive

Description:	Applies the enclosed directives only to regular-expression matching URLs
Syntax:	<code><LocationMatch regex> ... </LocationMatch></code>
Context:	server config, virtual host
Status:	Core
Module:	core

The `<LOCATIONMATCH>` directive limits the scope of the enclosed directives by URL, in an identical manner to `<LOCATION>`. However, it takes a regular expression as an argument instead of a simple string. For example:

```
<LocationMatch "/(extra|special)/data">
```

would match URLs that contained the substring `/extra/data` or `/special/data`.

See also

- How `<Directory>`, `<Location>` and `<Files>` sections work (p. 21) for an explanation of how these different sections are combined when a request is received

LogLevel Directive

Description:	Controls the verbosity of the ErrorLog
Syntax:	<code>LogLevel level</code>
Default:	<code>LogLevel warn</code>
Context:	server config, virtual host
Status:	Core
Module:	core

LOGLEVEL adjusts the verbosity of the messages recorded in the error logs (see **ERRORLOG** directive). The following levels are available, in order of decreasing significance:

Level	Description	Example
emerg	Emergencies - system is unusable.	"Child cannot open lock file. Exiting"
alert	Action must be taken immediately.	"getpwuid: couldn't determine user name from uid"
crit	Critical Conditions.	"socket: Failed to get a socket, exiting child"
error	Error conditions.	"Premature end of script headers"
warn	Warning conditions.	"child process 1234 did not exit, sending another SIGHUP"
notice	Normal but significant condition.	"httpd: caught SIGBUS, attempting to dump core in ..."
info	Informational.	"Server seems busy, (you may need to increase StartServers, or Min/MaxSpareServers)..."
debug	Debug-level messages	"Opening config file ..."

When a particular level is specified, messages from all other levels of higher significance will be reported as well. *E.g.*, when `LogLevel info` is specified, then messages with log levels of `notice` and `warn` will also be posted.

Using a level of at least `crit` is recommended.

For example:

```
LogLevel notice
```

⇒ Note

When logging to a regular file messages of the level `notice` cannot be suppressed and thus are always logged. However, this doesn't apply when logging is done using `syslog`.

MaxKeepAliveRequests Directive

Description:	Number of requests allowed on a persistent connection
Syntax:	<code>MaxKeepAliveRequests number</code>
Default:	<code>MaxKeepAliveRequests 100</code>
Context:	server config, virtual host
Status:	Core
Module:	core

The `MAXKEEPALIVEREQUESTS` directive limits the number of requests allowed per connection when `KEEPALIVE` is on. If it is set to 0, unlimited requests will be allowed. We recommend that this setting be kept to a high value for maximum server performance.

For example:

```
MaxKeepAliveRequests 500
```

NameVirtualHost Directive

Description:	Designates an IP address for name-virtual hosting
Syntax:	<code>NameVirtualHost addr[:port]</code>
Context:	server config
Status:	Core
Module:	core

The `NAMEVIRTUALHOST` directive is a required directive if you want to configure name-based virtual hosts (p. 110).

Although `addr` can be hostname it is recommended that you always use an IP address, e.g.

```
NameVirtualHost 111.22.33.44
```

With the `NAMEVIRTUALHOST` directive you specify the IP address on which the server will receive requests for the name-based virtual hosts. This will usually be the address to which your name-based virtual host names resolve. In cases where a firewall or other proxy receives the requests and forwards them on a different IP address to the server, you must specify the IP address of the physical interface on the machine which will be servicing the requests. If you have multiple name-based hosts on multiple addresses, repeat the directive for each address.

⇒ Note

Note, that the "main server" and any `_default_` servers will **never** be served for a request to a `NAMEVIRTUALHOST` IP address (unless for some reason you specify `NAMEVIRTUALHOST` but then don't define any `VIRTUALHOSTS` for that address).

Optionally you can specify a port number on which the name-based virtual hosts should be used, e.g.

```
NameVirtualHost 111.22.33.44:8080
```

IPv6 addresses must be enclosed in square brackets, as shown in the following example:

```
NameVirtualHost [2001:db8::a00:20ff:fea7:ccea]:8080
```

To receive requests on all interfaces, you can use an argument of `*`

```
NameVirtualHost *
```

⇒ Argument to `<VIRTUALHOST>` directive

Note that the argument to the `<VIRTUALHOST>` directive must exactly match the argument to the `NAMEVIRTUALHOST` directive.

```
NameVirtualHost 1.2.3.4
<VirtualHost 1.2.3.4>
# ...
</VirtualHost>
```

See also

- Virtual Hosts documentation (p. 110)

Options Directive

Description:	Configures what features are available in a particular directory
Syntax:	Options [+ -]option [[+ -]option] ...
Default:	Options All
Context:	server config, virtual host, directory, .htaccess
Override:	Options
Status:	Core
Module:	core

The `OPTIONS` directive controls which server features are available in a particular directory.

option can be set to `None`, in which case none of the extra features are enabled, or one or more of the following:

All All options except for `MultiViews`. This is the default setting.

ExecCGI Execution of CGI scripts using `MOD_CGI` is permitted.

FollowSymLinks The server will follow symbolic links in this directory.

⇒ Even though the server follows the symlink it does *not* change the pathname used to match against `<DIRECTORY>` sections.

Note also, that this option **gets ignored** if set inside a `<LOCATION>` section.

Includes Server-side includes provided by `MOD_INCLUDE` are permitted.

IncludesNOEXEC Server-side includes are permitted, but the `#exec cmd` and `#exec cgi` are disabled. It is still possible to `#include virtual` CGI scripts from `SCRIPTALIASED` directories.

Indexes If a URL which maps to a directory is requested, and there is no `DIRECTORYINDEX` (e.g., `index.html`) in that directory, then `MOD_AUTOINDEX` will return a formatted listing of the directory.

MultiViews Content negotiated (p. 47) "MultiViews" are allowed using `MOD_NEGOTIATION`.

SymLinksIfOwnerMatch The server will only follow symbolic links for which the target file or directory is owned by the same user id as the link.

⇒ **Note**

This option gets ignored if set inside a `<LOCATION>` section.

Normally, if multiple `OPTIONS` could apply to a directory, then the most specific one is used and others are ignored; the options are not merged. (See how sections are merged (p. 21) .) However if *all* the options on the `OPTIONS` directive are preceded by a + or – symbol, the options are merged. Any options preceded by a + are added to the options currently in force, and any options preceded by a – are removed from the options currently in force.



Warning

Mixing `OPTIONS` with a + or – with those without is not valid syntax, and is likely to cause unexpected results.

For example, without any + and – symbols:

```
<Directory /web/docs>
  Options Indexes FollowSymLinks
</Directory>
<Directory /web/docs/spec>
  Options Includes
</Directory>
```

then only `Includes` will be set for the `/web/docs/spec` directory. However if the second `OPTIONS` directive uses the + and – symbols:

```
<Directory /web/docs>
  Options Indexes FollowSymLinks
</Directory>
<Directory /web/docs/spec>
  Options +Includes -Indexes
</Directory>
```

then the options `FollowSymLinks` and `Includes` are set for the `/web/docs/spec` directory.

⇒ Note

Using `-IncludesNOEXEC` or `-Includes` disables server-side includes completely regardless of the previous setting.

The default in the absence of any other settings is `All`.

Require Directive

Description:	Selects which authenticated users can access a resource
Syntax:	<code>Require entity-name [entity-name] ...</code>
Context:	directory, <code>.htaccess</code>
Override:	<code>AuthConfig</code>
Status:	Core
Module:	<code>core</code>

This directive selects which authenticated users can access a resource. The allowed syntaxes are:

Require user `userid` [`userid`] ... Only the named users can access the resource.

Require group `group-name` [`group-name`] ... Only users in the named groups can access the resource.

Require valid-user All valid users can access the resource.

REQUIRE must be accompanied by **AUTHNAME** and **AUTHTYPE** directives, and directives such as **AUTHUSERFILE** and **AUTHGROUPFILE** (to define users and groups) in order to work correctly. Example:

```
AuthType Basic
AuthName "Restricted Resource"
AuthUserFile /web/users
AuthGroupFile /web/groups
Require group admin
```

Access controls which are applied in this way are effective for **all** methods. **This is what is normally desired.** If you wish to apply access controls only to specific methods, while leaving other methods unprotected, then place the **REQUIRE** statement into a `<LIMIT>` section.

See also

- [SATISFY](#)
- [MOD_ACCESS](#)

RLimitCPU Directive

Description:	Limits the CPU consumption of processes launched by Apache children
Syntax:	<code>RLimitCPU seconds max [seconds max]</code>
Default:	Unset; uses operating system defaults
Context:	server config, virtual host, directory, <code>.htaccess</code>
Override:	All
Status:	Core
Module:	<code>core</code>

Takes 1 or 2 parameters. The first parameter sets the soft resource limit for all processes and the second parameter sets the maximum resource limit. Either parameter can be a number, or `max` to indicate to the server that the limit should be set to the maximum allowed by the operating system configuration. Raising the maximum resource limit requires that the server is running as `root`, or in the initial startup phase.

This applies to processes forked off from Apache children servicing requests, not the Apache children themselves. This includes CGI scripts and SSI exec commands, but not any processes forked off from the Apache parent such as piped logs.

CPU resource limits are expressed in seconds per process.

See also

- [RLIMITMEM](#)
- [RLIMITNPROC](#)

RLimitMEM Directive

Description:	Limits the memory consumption of processes launched by Apache children
Syntax:	<code>RLimitMEM bytes max [bytes max]</code>
Default:	Unset; uses operating system defaults
Context:	server config, virtual host, directory, <code>.htaccess</code>
Override:	All
Status:	Core
Module:	core

Takes 1 or 2 parameters. The first parameter sets the soft resource limit for all processes and the second parameter sets the maximum resource limit. Either parameter can be a number, or `max` to indicate to the server that the limit should be set to the maximum allowed by the operating system configuration. Raising the maximum resource limit requires that the server is running as `root`, or in the initial startup phase.

This applies to processes forked off from Apache children servicing requests, not the Apache children themselves. This includes CGI scripts and SSI exec commands, but not any processes forked off from the Apache parent such as piped logs.

Memory resource limits are expressed in bytes per process.

See also

- [RLIMITCPU](#)
- [RLIMITNPROC](#)

RLimitNPROC Directive

Description:	Limits the number of processes that can be launched by processes launched by Apache children
Syntax:	<code>RLimitNPROC number max [number max]</code>
Default:	Unset; uses operating system defaults
Context:	server config, virtual host, directory, <code>.htaccess</code>
Override:	All
Status:	Core
Module:	core

Takes 1 or 2 parameters. The first parameter sets the soft resource limit for all processes and the second parameter sets the maximum resource limit. Either parameter can be a number, or `max` to indicate to the server that the limit should be set to the maximum allowed by the operating system configuration. Raising the maximum resource limit requires that the server is running as `root`, or in the initial startup phase.

This applies to processes forked off from Apache children servicing requests, not the Apache children themselves. This includes CGI scripts and SSI exec commands, but not any processes forked off from the Apache parent such as piped logs.

Process limits control the number of processes per user.

⇒ Note

If CGI processes are **not** running under user ids other than the web server user id, this directive will limit the number of processes that the server itself can create. Evidence of this situation will be indicated by **cannot fork** messages in the `error_log`.

See also

- [RLIMITMEM](#)
- [RLIMITCPU](#)

Satisfy Directive

Description:	Interaction between host-level access control and user authentication
Syntax:	<code>Satisfy Any All</code>
Default:	<code>Satisfy All</code>
Context:	directory, <code>.htaccess</code>
Override:	<code>AuthConfig</code>
Status:	Core
Module:	<code>core</code>
Compatibility:	Influenced by <code><LIMIT></code> and <code><LIMITEXCEPT></code> in version 2.0.51 and later

Access policy if both [ALLOW](#) and [REQUIRE](#) used. The parameter can be either `All` or `Any`. This directive is only useful if access to a particular area is being restricted by both username/password *and* client host address. In this case the default behavior (`All`) is to require that the client passes the address access restriction *and* enters a valid username and password. With the `Any` option the client will be granted access if they either pass the host restriction or enter a valid username and password. This can be used to password restrict an area, but to let clients from particular addresses in without prompting for a password.

For example, if you wanted to let people on your network have unrestricted access to a portion of your website, but require that people outside of your network provide a password, you could use a configuration similar to the following:

```
Require valid-user
Allow from 192.168.1
Satisfy Any
```

Since version 2.0.51 [SATISFY](#) directives can be restricted to particular methods by `<LIMIT>` and `<LIMITEXCEPT>` sections.

See also

- [ALLOW](#)
- [REQUIRE](#)

ScriptInterpreterSource Directive

Description:	Technique for locating the interpreter for CGI scripts
Syntax:	ScriptInterpreterSource Registry Registry-Strict Script
Default:	ScriptInterpreterSource Script
Context:	server config, virtual host, directory, .htaccess
Override:	FileInfo
Status:	Core
Module:	core
Compatibility:	Win32 only; option Registry-Strict is available in Apache 2.0 and later

This directive is used to control how Apache finds the interpreter used to run CGI scripts. The default setting is `Script`. This causes Apache to use the interpreter pointed to by the shebang line (first line, starting with `#!`) in the script. On Win32 systems this line usually looks like:

```
#!C:/Perl/bin/perl.exe
```

or, if `perl` is in the `PATH`, simply:

```
#!perl
```

Setting `ScriptInterpreterSource Registry` will cause the Windows Registry tree `HKEY_CLASSES_ROOT` to be searched using the script file extension (e.g., `.pl`) as a search key. The command defined by the registry subkey `Shell\ExecCGI\Command` or, if it does not exist, by the subkey `Shell\Open\Command` is used to open the script file. If the registry keys cannot be found, Apache falls back to the behavior of the `Script` option.



Security

Be careful when using `ScriptInterpreterSource Registry` with `SCRIPTALIAS`'ed directories, because Apache will try to execute **every** file within this directory. The Registry setting may cause undesired program calls on files which are typically not executed. For example, the default open command on `.htm` files on most Windows systems will execute Microsoft Internet Explorer, so any HTTP request for an `.htm` file existing within the script directory would start the browser in the background on the server. This is a good way to crash your system within a minute or so.

The option `Registry-Strict` which is new in Apache 2.0 does the same thing as `Registry` but uses only the subkey `Shell\ExecCGI\Command`. The `ExecCGI` key is not a common one. It must be configured manually in the windows registry and hence prevents accidental program calls on your system.

ServerAdmin Directive

Description:	Email address that the server includes in error messages sent to the client
Syntax:	ServerAdmin email-address
Context:	server config, virtual host
Status:	Core
Module:	core

The `SERVERADMIN` sets the e-mail address that the server includes in any error messages it returns to the client.

It may be worth setting up a dedicated address for this, e.g.

```
ServerAdmin www-admin@foo.example.com
```

as users do not always mention that they are talking about the server!

ServerAlias Directive

Description:	Alternate names for a host used when matching requests to name-virtual hosts
Syntax:	<code>ServerAlias hostname [hostname] ...</code>
Context:	virtual host
Status:	Core
Module:	core

The [SERVERALIAS](#) directive sets the alternate names for a host, for use with name-based virtual hosts (p. 111) .

```
<VirtualHost *>
ServerName server.domain.com
ServerAlias server server2.domain.com server2
# ...
</VirtualHost>
```

See also

- Apache Virtual Host documentation (p. 110)

ServerName Directive

Description:	Hostname and port that the server uses to identify itself
Syntax:	<code>ServerName fully-qualified-domain-name[:port]</code>
Context:	server config, virtual host
Status:	Core
Module:	core
Compatibility:	In version 2.0, this directive supersedes the functionality of the PORT directive from version 1.3.

The [SERVERNAME](#) directive sets the hostname and port that the server uses to identify itself. This is used when creating redirection URLs. For example, if the name of the machine hosting the web server is `simple.example.com`, but the machine also has the DNS alias `www.example.com` and you wish the web server to be so identified, the following directive should be used:

```
ServerName www.example.com:80
```

If no [SERVERNAME](#) is specified, then the server attempts to deduce the hostname by performing a reverse lookup on the IP address. If no port is specified in the [SERVERNAME](#), then the server will use the port from the incoming request. For optimal reliability and predictability, you should specify an explicit hostname and port using the [SERVERNAME](#) directive.

If you are using name-based virtual hosts (p. 111) , the [SERVERNAME](#) inside a `<VIRTUALHOST>` section specifies what hostname must appear in the request's `Host :` header to match this virtual host.

See the description of the [USECANONICALNAME](#) directive for settings which determine whether self-referential URL's (e.g., by the [MOD_DIR](#) module) will refer to the specified port, or to the port number given in the client's request.

See also

- Issues Regarding DNS and Apache (p. 136)
- Apache virtual host documentation (p. 110)
- [USECANONICALNAME](#)

- [NAMEVIRTUALHOST](#)
- [SERVERALIAS](#)

ServerPath Directive

Description:	Legacy URL pathname for a name-based virtual host that is accessed by an incompatible browser
Syntax:	<code>ServerPath URL-path</code>
Context:	virtual host
Status:	Core
Module:	core

The [SERVERPATH](#) directive sets the legacy URL pathname for a host, for use with name-based virtual hosts (p. 110).

See also

- Apache Virtual Host documentation (p. 110)

ServerRoot Directive

Description:	Base directory for the server installation
Syntax:	<code>ServerRoot directory-path</code>
Default:	<code>ServerRoot /usr/local/apache</code>
Context:	server config
Status:	Core
Module:	core

The [SERVERROOT](#) directive sets the directory in which the server lives. Typically it will contain the subdirectories `conf/` and `logs/`. Relative paths in other configuration directives (such as [INCLUDE](#) or [LOADMODULE](#), for example) are taken as relative to this directory.

Example

```
ServerRoot /home/httpd
```

See also

- the `-d` option to `httpd` (p. 14)
- the security tips (p. 40) for information on how to properly set permissions on the [SERVERROOT](#)

ServerSignature Directive

Description:	Configures the footer on server-generated documents
Syntax:	<code>ServerSignature On Off EMail</code>
Default:	<code>ServerSignature Off</code>
Context:	server config, virtual host, directory, <code>.htaccess</code>
Override:	All
Status:	Core
Module:	core

The [SERVERSIGNATURE](#) directive allows the configuration of a trailing footer line under server-generated documents (error messages, [MOD_PROXY](#) ftp directory listings, [MOD_INFO](#) output, ...). The reason why you would want to enable

such a footer line is that in a chain of proxies, the user often has no possibility to tell which of the chained servers actually produced a returned error message.

The `Off` setting, which is the default, suppresses the footer line (and is therefore compatible with the behavior of Apache-1.2 and below). The `On` setting simply adds a line with the server version number and `SERVERNAME` of the serving virtual host, and the `EMail` setting additionally creates a "mailto:" reference to the `SERVERADMIN` of the referenced document.

After version 2.0.44, the details of the server version number presented are controlled by the `SERVERTOKENS` directive.

See also

- [SERVERTOKENS](#)

ServerTokens Directive

Description:	Configures the <code>Server</code> HTTP response header
Syntax:	<code>ServerTokens Major Minor Min[imal] Prod[uctOnly] OS Full</code>
Default:	<code>ServerTokens Full</code>
Context:	server config
Status:	Core
Module:	core

This directive controls whether `Server` response header field which is sent back to clients includes a description of the generic OS-type of the server as well as information about compiled-in modules.

ServerTokens Prod[uctOnly] Server sends (e.g.): `Server: Apache`

ServerTokens Major Server sends (e.g.): `Server: Apache/2`

ServerTokens Minor Server sends (e.g.): `Server: Apache/2.0`

ServerTokens Min[imal] Server sends (e.g.): `Server: Apache/2.0.41`

ServerTokens OS Server sends (e.g.): `Server: Apache/2.0.41 (Unix)`

ServerTokens Full (or not specified) Server sends (e.g.): `Server: Apache/2.0.41 (Unix)
PHP/4.2.2 MyMod/1.2`

This setting applies to the entire server, and cannot be enabled or disabled on a virtualhost-by-virtualhost basis.

After version 2.0.44, this directive also controls the information presented by the `SERVERSIGNATURE` directive.

See also

- [SERVERSIGNATURE](#)

SetHandler Directive

Description:	Forces all matching files to be processed by a handler
Syntax:	<code>SetHandler handler-name None</code>
Context:	server config, virtual host, directory, <code>.htaccess</code>
Override:	<code>FileInfo</code>
Status:	Core
Module:	core
Compatibility:	Moved into the core in Apache 2.0

When placed into an `.htaccess` file or a `<DIRECTORY>` or `<LOCATION>` section, this directive forces all matching files to be parsed through the handler (p. 65) given by handler-name. For example, if you had a directory you wanted to be parsed entirely as imagemap rule files, regardless of extension, you might put the following into an `.htaccess` file in that directory:

```
SetHandler imap-file
```

Another example: if you wanted to have the server display a status report whenever a URL of `http://servername/status` was called, you might put the following into `httpd.conf`:

```
<Location /status>
    SetHandler server-status
</Location>
```

You can override an earlier defined `SETHANDLER` directive by using the value `None`.

See also

- [ADDFILTER](#)

SetInputFilter Directive

Description:	Sets the filters that will process client requests and POST input
Syntax:	<code>SetInputFilter filter[;filter...]</code>
Context:	server config, virtual host, directory, <code>.htaccess</code>
Override:	FileInfo
Status:	Core
Module:	core

The `SETINPUTFILTER` directive sets the filter or filters which will process client requests and POST input when they are received by the server. This is in addition to any filters defined elsewhere, including the `ADDINPUTFILTER` directive.

If more than one filter is specified, they must be separated by semicolons in the order in which they should process the content.

See also

- [Filters \(p. 67\)](#) documentation

SetOutputFilter Directive

Description:	Sets the filters that will process responses from the server
Syntax:	<code>SetOutputFilter filter[;filter...]</code>
Context:	server config, virtual host, directory, <code>.htaccess</code>
Override:	FileInfo
Status:	Core
Module:	core

The `SETOUTPUTFILTER` directive sets the filters which will process responses from the server before they are sent to the client. This is in addition to any filters defined elsewhere, including the `ADDOUTPUTFILTER` directive.

For example, the following configuration will process all files in the `/www/data/` directory for server-side includes.

```
<Directory /www/data/>
  SetOutputFilter INCLUDES
</Directory>
```

If more than one filter is specified, they must be separated by semicolons in the order in which they should process the content.

See also

- [Filters \(p. 67\) documentation](#)

TimeOut Directive

Description:	Amount of time the server will wait for certain events before failing a request
Syntax:	TimeOut seconds
Default:	TimeOut 300
Context:	server config, virtual host
Status:	Core
Module:	core

The [TIMEOUT](#) directive currently defines the amount of time Apache will wait for three things:

1. The total amount of time it takes to receive a GET request.
2. The amount of time between receipt of TCP packets on a POST or PUT request.
3. The amount of time between ACKs on transmissions of TCP packets in responses.

We plan on making these separately configurable at some point down the road. The timer used to default to 1200 before 1.2, but has been lowered to 300 which is still far more than necessary in most situations. It is not set any lower by default because there may still be odd places in the code where the timer is not reset when a packet is sent.

TraceEnable Directive

Description:	Determines the behaviour on TRACE requests
Syntax:	TraceEnable [on off extended]
Default:	TraceEnable on
Context:	server config
Status:	Core
Module:	core
Compatibility:	Available in Apache 1.3.34, 2.0.55 and later

This directive overrides the behavior of TRACE for both the core server and [MOD_PROXY](#). The default `TraceEnable on` permits TRACE requests per RFC 2616, which disallows any request body to accompany the request. `TraceEnable off` causes the core server and [MOD_PROXY](#) to return a 405 (Method not allowed) error to the client.

Finally, for testing and diagnostic purposes only, request bodies may be allowed using the non-compliant `TraceEnable extended` directive. The core (as an origin server) will restrict the request body to 64k (plus 8k for chunk headers if `Transfer-Encoding: chunked` is used). The core will reflect the full headers and all chunk headers with the response body. As a proxy server, the request body is not restricted to 64k.

UseCanonicalName Directive

Description:	Configures how the server determines its own name and port
Syntax:	UseCanonicalName On Off DNS
Default:	UseCanonicalName On
Context:	server config, virtual host, directory
Status:	Core
Module:	core

In many situations Apache must construct a *self-referential* URL – that is, a URL that refers back to the same server. With `UseCanonicalName On` Apache will use the hostname and port specified in the `SERVERNAME` directive to construct the canonical name for the server. This name is used in all self-referential URLs, and for the values of `SERVER_NAME` and `SERVER_PORT` in CGIs.

With `UseCanonicalName Off` Apache will form self-referential URLs using the hostname and port supplied by the client if any are supplied (otherwise it will use the canonical name, as defined above). These values are the same that are used to implement name based virtual hosts (p. 111), and are available with the same clients. The CGI variables `SERVER_NAME` and `SERVER_PORT` will be constructed from the client supplied values as well.

An example where this may be useful is on an intranet server where you have users connecting to the machine using short names such as `www`. You'll notice that if the users type a shortname, and a URL which is a directory, such as `http://www/splat`, *without the trailing slash* then Apache will redirect them to `http://www.domain.com/splat/`. If you have authentication enabled, this will cause the user to have to authenticate twice (once for `www` and once again for `www.domain.com` – see the FAQ on this subject for more information³). But if `USECANONICALNAME` is set `Off`, then Apache will redirect to `http://www/splat/`.

There is a third option, `UseCanonicalName DNS`, which is intended for use with mass IP-based virtual hosting to support ancient clients that do not provide a `Host:` header. With this option Apache does a reverse DNS lookup on the server IP address that the client connected to in order to work out self-referential URLs.



Warning

If CGIs make assumptions about the values of `SERVER_NAME` they may be broken by this option. The client is essentially free to give whatever value they want as a hostname. But if the CGI is only using `SERVER_NAME` to construct self-referential URLs then it should be just fine.

See also

- [SERVERNAME](#)
- [LISTEN](#)

VirtualHost Directive

Description:	Contains directives that apply only to a specific hostname or IP address
Syntax:	<code><VirtualHost addr[:port] [addr[:port]] ...> ...</code> <code></VirtualHost></code>
Context:	server config
Status:	Core
Module:	core

`<VIRTUALHOST>` and `</VirtualHost>` are used to enclose a group of directives that will apply only to a particular virtual host. Any directive that is allowed in a virtual host context may be used. When the server receives a request for a document on a particular virtual host, it uses the configuration directives enclosed in the `<VIRTUALHOST>` section. `Addr` can be:

³<http://httpd.apache.org/docs/misc/FAQ.html#prompted-twice>

- The IP address of the virtual host;
- A fully qualified domain name for the IP address of the virtual host;
- The character *, which is used only in combination with `NameVirtualHost *` to match all IP addresses; or
- The string `_default_`, which is used only with IP virtual hosting to catch unmatched IP addresses.

Example

```
<VirtualHost 10.1.2.3>
  ServerAdmin webmaster@host.foo.com
  DocumentRoot /www/docs/host.foo.com
  ServerName host.foo.com
  ErrorLog logs/host.foo.com-error_log
  TransferLog logs/host.foo.com-access_log
</VirtualHost>
```

IPv6 addresses must be specified in square brackets because the optional port number could not be determined otherwise. An IPv6 example is shown below:

```
<VirtualHost [2001:db8::a00:20ff:fea7:ccea]>
  ServerAdmin webmaster@host.example.com
  DocumentRoot /www/docs/host.example.com
  ServerName host.example.com
  ErrorLog logs/host.example.com-error_log
  TransferLog logs/host.example.com-access_log
</VirtualHost>
```

Each Virtual Host must correspond to a different IP address, different port number or a different host name for the server, in the former case the server machine must be configured to accept IP packets for multiple addresses. (If the machine does not have multiple network interfaces, then this can be accomplished with the `ifconfig alias` command – if your OS supports it).

 **Note**

The use of `<VIRTUALHOST>` does **not** affect what addresses Apache listens on. You may need to ensure that Apache is listening on the correct addresses using `LISTEN`.

When using IP-based virtual hosting, the special name `_default_` can be specified in which case this virtual host will match any IP address that is not explicitly listed in another virtual host. In the absence of any `_default_` virtual host the "main" server config, consisting of all those definitions outside any `VirtualHost` section, is used when no IP-match occurs. (But note that any IP address that matches a `NAMEVIRTUALHOST` directive will use neither the "main" server config nor the `_default_` virtual host. See the name-based virtual hosting (p. 111) documentation for further details.)

You can specify a `:port` to change the port that is matched. If unspecified then it defaults to the same port as the most recent `LISTEN` statement of the main server. You may also specify `*` to match all ports on that address. (This is recommended when used with `_default_`.)

**Security**

See the security tips (p. 40) document for details on why your security could be compromised if the directory where log files are stored is writable by anyone other than the user that starts the server.

See also

- [Apache Virtual Host documentation \(p. 110\)](#)
- [Issues Regarding DNS and Apache \(p. 136\)](#)
- [Setting which addresses and ports Apache uses \(p. 57\)](#)
- [How <Directory>, <Location> and <Files> sections work \(p. 21\)](#) for an explanation of how these different sections are combined when a request is received

10.4 Apache Module `mod_access`

Description:	Provides access control based on client hostname, IP address, or other characteristics of the client request.
Status:	Base
ModuleIdentifier:	<code>access_module</code>
SourceFile:	<code>mod_access.c</code>
Compatibility:	Available only in versions prior to 2.1

Summary

The directives provided by `MOD_ACCESS` are used in `<DIRECTORY>`, `<FILES>`, and `<LOCATION>` sections as well as `.htaccess` (p. 302) files to control access to particular parts of the server. Access can be controlled based on the client hostname, IP address, or other characteristics of the client request, as captured in environment variables (p. 60). The `ALLOW` and `DENY` directives are used to specify which clients are or are not allowed access to the server, while the `ORDER` directive sets the default access state, and configures how the `ALLOW` and `DENY` directives interact with each other.

Both host-based access restrictions and password-based authentication may be implemented simultaneously. In that case, the `SATISFY` directive is used to determine how the two sets of restrictions interact.

In general, access restriction directives apply to all access methods (`GET`, `PUT`, `POST`, etc). This is the desired behavior in most cases. However, it is possible to restrict some methods, while leaving other methods unrestricted, by enclosing the directives in a `<LIMIT>` section.

Directives

- `Allow`
- `Deny`
- `Order`

See also

- `SATISFY`
- `REQUIRE`

Allow Directive

Description:	Controls which hosts can access an area of the server
Syntax:	<code>Allow from all host env=env-variable [host env=env-variable]</code> ...
Context:	directory, <code>.htaccess</code>
Override:	Limit
Status:	Base
Module:	<code>mod_access</code>

The `ALLOW` directive affects which hosts can access an area of the server. Access can be controlled by hostname, IP address, IP address range, or by other characteristics of the client request captured in environment variables.

The first argument to this directive is always `from`. The subsequent arguments can take three different forms. If `Allow from all` is specified, then all hosts are allowed access, subject to the configuration of the `DENY` and `ORDER` directives as discussed below. To allow only particular hosts or groups of hosts to access the server, the host can be specified in any of the following formats:

A (partial) domain-name**Example:**

```
Allow from apache.org
Allow from .net example.edu
```

Hosts whose names match, or end in, this string are allowed access. Only complete components are matched, so the above example will match `foo.apache.org` but it will not match `fooapache.org`. This configuration will cause Apache to perform a double reverse DNS lookup on the client IP address, regardless of the setting of the [HOSTNAMELOOKUPS](#) directive. It will do a reverse DNS lookup on the IP address to find the associated hostname, and then do a forward lookup on the hostname to assure that it matches the original IP address. Only if the forward and reverse DNS are consistent and the hostname matches will access be allowed.

A full IP address**Example:**

```
Allow from 10.1.2.3
Allow from 192.168.1.104 192.168.1.205
```

An IP address of a host allowed access

A partial IP address**Example:**

```
Allow from 10.1
Allow from 10 172.20 192.168.2
```

The first 1 to 3 bytes of an IP address, for subnet restriction.

A network/netmask pair**Example:**

```
Allow from 10.1.0.0/255.255.0.0
```

A network a.b.c.d, and a netmask w.x.y.z. For more fine-grained subnet restriction.

A network/nnn CIDR specification**Example:**

```
Allow from 10.1.0.0/16
```

Similar to the previous case, except the netmask consists of nnn high-order 1 bits.

Note that the last three examples above match exactly the same set of hosts.

IPv6 addresses and IPv6 subnets can be specified as shown below:

```
Allow from 2001:db8::a00:20ff:fea7:ccea
Allow from 2001:db8::a00:20ff:fea7:ccea/10
```

The third format of the arguments to the [ALLOW](#) directive allows access to the server to be controlled based on the existence of an environment variable (p. 60). When `Allow from env=env-variable` is specified, then the request is allowed access if the environment variable `env-variable` exists. The server provides the ability to set environment variables in a flexible way based on characteristics of the client request using the directives provided by [MOD.SETENVIF](#). Therefore, this directive can be used to allow access based on such factors as the clients `User-Agent` (browser type), `Referer`, or other HTTP request header fields.

Example:

```
SetEnvIf User-Agent ^KnockKnock/2\.0 let_me_in
<Directory /docroot>
    Order Deny,Allow
    Deny from all
    Allow from env=let_me_in
</Directory>
```

In this case, browsers with a user-agent string beginning with `KnockKnock/2.0` will be allowed access, and all others will be denied.

Deny Directive

Description:	Controls which hosts are denied access to the server
Syntax:	<code>Deny from all host env=env-variable [host env=env-variable]</code> <code>...</code>
Context:	directory, <code>.htaccess</code>
Override:	Limit
Status:	Base
Module:	<code>mod_access</code>

This directive allows access to the server to be restricted based on hostname, IP address, or environment variables. The arguments for the `DENY` directive are identical to the arguments for the `ALLOW` directive.

Order Directive

Description:	Controls the default access state and the order in which <code>ALLOW</code> and <code>DENY</code> are evaluated.
Syntax:	<code>Order ordering</code>
Default:	<code>Order Deny,Allow</code>
Context:	directory, <code>.htaccess</code>
Override:	Limit
Status:	Base
Module:	<code>mod_access</code>

The `ORDER` directive, along with the `ALLOW` and `DENY` directives, controls a three-pass access control system. The first pass processes either all `ALLOW` or all `DENY` directives, as specified by the `ORDER` directive. The second pass parses the rest of the directives (`DENY` or `ALLOW`). The third pass applies to all requests which do not match either of the first two.

Note that all `ALLOW` and `DENY` directives are processed, unlike a typical firewall, where only the first match is used. The last match is effective (also unlike a typical firewall). Additionally, the order in which lines appear in the configuration files is not significant – all `ALLOW` lines are processed as one group, all `DENY` lines are considered as another, and the default state is considered by itself.

Ordering is one of:

Allow,Deny First, all `ALLOW` directives are evaluated; at least one must match, or the request is rejected. Next, all `DENY` directives are evaluated. If any matches, the request is rejected. Last, any requests which do not match an `ALLOW` or a `DENY` directive are denied by default.

Deny,Allow First, all `DENY` directives are evaluated; if any match, the request is denied **unless** it also matches an `ALLOW` directive. Any requests which do not match any `ALLOW` or `DENY` directives are permitted.

Mutual-failure This order has the same effect as `Order Allow,Deny` and is deprecated in its favor.

Keywords may only be separated by a comma; *no whitespace* is allowed between them.

Match	Allow,Deny result	Deny,Allow result
Match Allow only	Request allowed	Request allowed
Match Deny only	Request denied	Request denied
No match	Default to second directive: Denied	Default to second directive: Allowed
Match both Allow & Deny	Final match controls: Denied	Final match controls: Allowed

In the following example, all hosts in the `apache.org` domain are allowed access; all other hosts are denied access.

```
Order Deny,Allow
Deny from all
Allow from apache.org
```

In the next example, all hosts in the `apache.org` domain are allowed access, except for the hosts which are in the `foo.apache.org` subdomain, who are denied access. All hosts not in the `apache.org` domain are denied access because the default state is to **DENY** access to the server.

```
Order Allow,Deny
Allow from apache.org
Deny from foo.apache.org
```

On the other hand, if the **ORDER** in the last example is changed to `Deny, Allow`, all hosts will be allowed access. This happens because, regardless of the actual ordering of the directives in the configuration file, the `Allow from apache.org` will be evaluated last and will override the `Deny from foo.apache.org`. All hosts not in the `apache.org` domain will also be allowed access because the default state is **ALLOW**.

The presence of an **ORDER** directive can affect access to a part of the server even in the absence of accompanying **ALLOW** and **DENY** directives because of its effect on the default access state. For example,

```
<Directory /www>
  Order Allow,Deny
</Directory>
```

will **DENY** all access to the `/www` directory because the default access state is set to **DENY**.

The **ORDER** directive controls the order of access directive processing only within each phase of the server's configuration processing. This implies, for example, that an **ALLOW** or **DENY** directive occurring in a `<LOCATION>` section will always be evaluated after an **ALLOW** or **DENY** directive occurring in a `<DIRECTORY>` section or `.htaccess` file, regardless of the setting of the **ORDER** directive. For details on the merging of configuration sections, see the documentation on How Directory, Location and Files sections work (p. 21).

10.5 Apache Module `mod_actions`

Description:	This module provides for executing CGI scripts based on media type or request method.
Status:	Base
ModuleIdentifier:	actions_module
SourceFile:	mod_actions.c

Summary

This module has two directives. The [ACTION](#) directive lets you run CGI scripts whenever a file of a certain type is requested. The [SCRIPT](#) directive lets you run CGI scripts whenever a particular method is used in a request. This makes it much easier to execute scripts that process files.

Directives

- Action
- Script

See also

- [MOD_CGI](#)
- Dynamic Content with CGI (p. 185)
- Apache's Handler Use (p. 65)

Action Directive

Description:	Activates a CGI script for a particular handler or content-type
Syntax:	Action action-type cgi-script
Context:	server config, virtual host, directory, .htaccess
Override:	FileInfo
Status:	Base
Module:	mod_actions

This directive adds an action, which will activate cgi-script when action-type is triggered by the request. The cgi-script is the URL-path to a resource that has been designated as a CGI script using [SCRIPTALIAS](#) or [ADDFHANDLER](#). The action-type can be either a handler (p. 65) or a MIME content type. It sends the URL and file path of the requested document using the standard CGI `PATH_INFO` and `PATH_TRANSLATED` environment variables.

Examples

```
# Requests for files of a particular type:
Action image/gif /cgi-bin/images.cgi

# Files of a particular file extension
AddHandler my-file-type .xyz
Action my-file-type /cgi-bin/program.cgi
```

In the first example, requests for files with a MIME content type of `image/gif` will instead be handled by the specified cgi script `/cgi-bin/images.cgi`.

In the second example, requests for files with a file extension of `.xyz` are handled instead by the specified cgi script `/cgi-bin/program.cgi`.

See also

- [ADDFHANDLER](#)

Script Directive

Description:	Activates a CGI script for a particular request method.
Syntax:	<code>Script method cgi-script</code>
Context:	server config, virtual host, directory
Status:	Base
Module:	<code>mod_actions</code>

This directive adds an action, which will activate `cgi-script` when a file is requested using the method of method. The `cgi-script` is the URL-path to a resource that has been designated as a CGI script using [SCRIPTALIAS](#) or [ADHANDLER](#). The URL and file path of the requested document is sent using the standard CGI `PATH_INFO` and `PATH_TRANSLATED` environment variables.

⇒ Any arbitrary method name may be used. **Method names are case-sensitive**, so `Script PUT` and `Script put` have two entirely different effects.

Note that the `Script` command defines default actions only. If a CGI script is called, or some other resource that is capable of handling the requested method internally, it will do so. Also note that `Script` with a method of `GET` will only be called if there are query arguments present (*e.g.*, `foo.html?hi`). Otherwise, the request will proceed normally.

Examples

```
# For <ISINDEX>-style searching
Script GET /cgi-bin/search

# A CGI PUT handler
Script PUT /~bob/put.cgi
```

10.6 Apache Module `mod_alias`

Description:	Provides for mapping different parts of the host filesystem in the document tree and for URL redirection
Status:	Base
ModuleIdentifier:	alias_module
SourceFile:	mod_alias.c

Summary

The directives contained in this module allow for manipulation and control of URLs as requests arrive at the server. The [ALIAS](#) and [SCRIPTALIAS](#) directives are used to map between URLs and filesystem paths. This allows for content which is not directly under the [DOCUMENTROOT](#) served as part of the web document tree. The [SCRIPTALIAS](#) directive has the additional effect of marking the target directory as containing only CGI scripts.

The [REDIRECT](#) directives are used to instruct clients to make a new request with a different URL. They are often used when a resource has moved to a new location.

[MOD_ALIAS](#) is designed to handle simple URL manipulation tasks. For more complicated tasks such as manipulating the query string, use the tools provided by [MOD_REWRITE](#).

Directives

- [Alias](#)
- [AliasMatch](#)
- [Redirect](#)
- [RedirectMatch](#)
- [RedirectPermanent](#)
- [RedirectTemp](#)
- [ScriptAlias](#)
- [ScriptAliasMatch](#)

See also

- [MOD_REWRITE](#)
- Mapping URLs to the filesystem (p. 36)

Order of Processing

Aliases and Redirects occurring in different contexts are processed like other directives according to standard merging rules (p. 21) . But when multiple Aliases or Redirects occur in the same context (for example, in the same [<VIRTU-ALHOST>](#) section) they are processed in a particular order.

First, all Redirects are processed before Aliases are processed, and therefore a request that matches a [REDIRECT](#) or [REDIRECTMATCH](#) will never have Aliases applied. Second, the Aliases and Redirects are processed in the order they appear in the configuration files, with the first match taking precedence.

For this reason, when two or more of these directives apply to the same sub-path, you must list the most specific path first in order for all the directives to have an effect. For example, the following configuration will work as expected:

```
Alias /foo/bar /baz
Alias /foo /gaq
```

But if the above two directives were reversed in order, the `/foo` [ALIAS](#) would always match before the `/foo/bar` [ALIAS](#), so the latter directive would be ignored.

Alias Directive

Description:	Maps URLs to filesystem locations
Syntax:	Alias URL-path file-path directory-path
Context:	server config, virtual host
Status:	Base
Module:	mod_alias

The [ALIAS](#) directive allows documents to be stored in the local filesystem other than under the [DOCUMENTROOT](#). URLs with a (%-decoded) path beginning with url-path will be mapped to local files beginning with directory-path. The url-path is case-sensitive, even on case-insensitive file systems.

Example:

```
Alias /image /ftp/pub/image
```

A request for `http://myserver/image/foo.gif` would cause the server to return the file `/ftp/pub/image/foo.gif`.

Note that if you include a trailing `/` on the url-path then the server will require a trailing `/` in order to expand the alias. That is, if you use `Alias /icons/ /usr/local/apache/icons/` then the url `/icons` will not be aliased.

Note that you may need to specify additional [<DIRECTORY>](#) sections which cover the *destination* of aliases. Aliasing occurs before [<DIRECTORY>](#) sections are checked, so only the destination of aliases are affected. (Note however [<LOCATION>](#) sections are run through once before aliases are performed, so they will apply.)

In particular, if you are creating an `Alias` to a directory outside of your [DOCUMENTROOT](#), you may need to explicitly permit access to the target directory.

Example:

```
Alias /image /ftp/pub/image
<Directory /ftp/pub/image>
    Order allow,deny
    Allow from all
</Directory>
```

AliasMatch Directive

Description:	Maps URLs to filesystem locations using regular expressions
Syntax:	AliasMatch regex file-path directory-path
Context:	server config, virtual host
Status:	Base
Module:	mod_alias

This directive is equivalent to [ALIAS](#), but makes use of standard regular expressions, instead of simple prefix matching. The supplied regular expression is matched against the URL-path, and if it matches, the server will substitute any parenthesized matches into the given string and use it as a filename. For example, to activate the `/icons` directory, one might use:

```
AliasMatch ^/icons(.*) /usr/local/apache/icons$1
```

It is also possible to construct an alias with case-insensitive matching of the url-path:

```
AliasMatch (?i)~/image(.*) /ftp/pub/image$1
```

Redirect Directive

Description:	Sends an external redirect asking the client to fetch a different URL
Syntax:	Redirect [status] URL-path URL
Context:	server config, virtual host, directory, .htaccess
Override:	FileInfo
Status:	Base
Module:	mod_alias

The Redirect directive maps an old URL into a new one by asking the client to refetch the resource at the new location.

The old *URL-path* is a case-sensitive (%-decoded) path beginning with a slash. A relative path is not allowed. The new *URL* should be an absolute URL beginning with a scheme and hostname, but a URL-path beginning with a slash may also be used, in which case the scheme and hostname of the current server will be added.

Example:

```
Redirect /service http://foo2.bar.com/service
```

If the client requests `http://myserver/service/foo.txt`, it will be told to access `http://foo2.bar.com/service/foo.txt` instead.

⇒ Note

Redirect directives take precedence over Alias and ScriptAlias directives, irrespective of their ordering in the configuration file. Also, URL-path must be a fully qualified URL, not a relative path, even when used with .htaccess files or inside of <DIRECTORY> sections.

If no status argument is given, the redirect will be "temporary" (HTTP status 302). This indicates to the client that the resource has moved temporarily. The status argument can be used to return other HTTP status codes:

permanent Returns a permanent redirect status (301) indicating that the resource has moved permanently.

temp Returns a temporary redirect status (302). This is the default.

seeother Returns a "See Other" status (303) indicating that the resource has been replaced.

gone Returns a "Gone" status (410) indicating that the resource has been permanently removed. When this status is used the URL argument should be omitted.

Other status codes can be returned by giving the numeric status code as the value of status. If the status is between 300 and 399, the URL argument must be present, otherwise it must be omitted. Note that the status must be known to the Apache code (see the function `send_error_response` in `http_protocol.c`).

Example:

```
Redirect permanent /one http://example.com/two
Redirect 303 /three http://example.com/other
```

RedirectMatch Directive

Description:	Sends an external redirect based on a regular expression match of the current URL
Syntax:	RedirectMatch [status] regex URL
Context:	server config, virtual host, directory, .htaccess
Override:	FileInfo
Status:	Base
Module:	mod_alias

This directive is equivalent to [REDIRECT](#), but makes use of standard regular expressions, instead of simple prefix matching. The supplied regular expression is matched against the URL-path, and if it matches, the server will substitute any parenthesized matches into the given string and use it as a filename. For example, to redirect all GIF files to like-named JPEG files on another server, one might use:

```
RedirectMatch (.*)\.gif$ http://www.anotherserver.com$1.jpg
```

RedirectPermanent Directive

Description:	Sends an external permanent redirect asking the client to fetch a different URL
Syntax:	RedirectPermanent URL-path URL
Context:	server config, virtual host, directory, .htaccess
Override:	FileInfo
Status:	Base
Module:	mod_alias

This directive makes the client know that the Redirect is permanent (status 301). Exactly equivalent to `Redirect permanent`.

RedirectTemp Directive

Description:	Sends an external temporary redirect asking the client to fetch a different URL
Syntax:	RedirectTemp URL-path URL
Context:	server config, virtual host, directory, .htaccess
Override:	FileInfo
Status:	Base
Module:	mod_alias

This directive makes the client know that the Redirect is only temporary (status 302). Exactly equivalent to `Redirect temp`.

ScriptAlias Directive

Description:	Maps a URL to a filesystem location and designates the target as a CGI script
Syntax:	ScriptAlias URL-path file-path directory-path
Context:	server config, virtual host
Status:	Base
Module:	mod_alias

The [SCRIPTALIAS](#) directive has the same behavior as the [ALIAS](#) directive, except that in addition it marks the target directory as containing CGI scripts that will be processed by [MOD_CGI](#)'s cgi-script handler. URLs with a case-sensitive (%-decoded) path beginning with URL-path will be mapped to scripts beginning with the second argument, which is a full pathname in the local filesystem.

Example:

```
ScriptAlias /cgi-bin/ /web/cgi-bin/
```

A request for `http://myserver/cgi-bin/foo` would cause the server to run the script `/web/cgi-bin/foo`. This configuration is essentially equivalent to:

```
Alias /cgi-bin/ /web/cgi-bin/
<Location /cgi-bin >
    SetHandler cgi-script
    Options +ExecCGI
</Location>
```



It is safer to avoid placing CGI scripts under the `DOCUMENTROOT` in order to avoid accidentally revealing their source code if the configuration is ever changed. The `SCRIPTALIAS` makes this easy by mapping a URL and designating CGI scripts at the same time. If you do choose to place your CGI scripts in a directory already accessible from the web, do not use `SCRIPTALIAS`. Instead, use `<DIRECTORY>`, `SETHANDLER`, and `OPTIONS` as in:

```
<Directory /usr/local/apache2/htdocs/cgi-bin >
    SetHandler cgi-script
    Options ExecCGI
</Directory>
```

This is necessary since multiple URL-paths can map to the same filesystem location, potentially bypassing the `SCRIPTALIAS` and revealing the source code of the CGI scripts if they are not restricted by a `DIRECTORY` section.

See also

- CGI Tutorial (p. 185)

ScriptAliasMatch Directive

Description:	Maps a URL to a filesystem location using a regular expression and designates the target as a CGI script
Syntax:	<code>ScriptAliasMatch regex file-path directory-path</code>
Context:	server config, virtual host
Status:	Base
Module:	<code>mod_alias</code>

This directive is equivalent to `SCRIPTALIAS`, but makes use of standard regular expressions, instead of simple prefix matching. The supplied regular expression is matched against the URL-path, and if it matches, the server will substitute any parenthesized matches into the given string and use it as a filename. For example, to activate the standard `/cgi-bin`, one might use:

```
ScriptAliasMatch ^/cgi-bin(.*) /usr/local/apache/cgi-bin$1
```

10.7 Apache Module mod_asis

Description:	Sends files that contain their own HTTP headers
Status:	Base
ModuleIdentifier:	asis_module
SourceFile:	mod_asis.c

Summary

This module provides the handler `send-as-is` which causes Apache to send the document without adding most of the usual HTTP headers.

This can be used to send any kind of data from the server, including redirects and other special HTTP responses, without requiring a cgi-script or an nph script.

For historical reasons, this module will also process any file with the mime type `httpd/send-as-is`.

Directives This module provides no directives.

See also

- [MOD_HEADERS](#)
- [MOD_CERN_META](#)
- Apache's Handler Use (p. 65)

Usage

In the server configuration file, associate files with the `send-as-is` handler *e.g.*

```
AddHandler send-as-is asis
```

The contents of any file with a `.asis` extension will then be sent by Apache to the client with almost no changes. In particular, HTTP headers are derived from the file itself according to [MOD_CGI](#) rules, so an `asis` file must include valid headers, and may also use the CGI `Status:` header to determine the HTTP response code.

Here's an example of a file whose contents are sent *as is* so as to tell the client that a file has redirected.

```
Status: 301 Now where did I leave that URL
Location: http://xyz.abc.com/foo/bar.html
Content-type: text/html

<html>
<head>
<title>Lame excuses'R'us</title>
</head>
<body>
<h1>Fred's exceptionally wonderful page has moved to
<a href="http://xyz.abc.com/foo/bar.html">Joe's</a> site.
</h1>
</body>
</html>
```

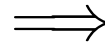
 **Notes:**

The server always adds a `Date:` and `Server:` header to the data returned to the client, so these should not be included in the file. The server does *not* add a `Last-Modified` header; it probably should.

10.8 Apache Module mod_auth

Description:	User authentication using text files
Status:	Base
ModuleIdentifier:	auth_module
SourceFile:	mod_auth.c
Compatibility:	Available only in versions prior to 2.1

Summary

This module allows the use of HTTP Basic Authentication to restrict access by looking up users in plain text password and group files. Similar functionality and greater scalability is provided by [MOD_AUTH_DBM](#). HTTP Digest Authentication is provided by [MOD_AUTH_DIGEST](#).

Directives

- [AuthAuthoritative](#)
- [AuthGroupFile](#)
- [AuthUserFile](#)

See also

- [REQUIRE](#)
- [SATISFY](#)
- [AUTHNAME](#)
- [AUTHTYPE](#)

AuthAuthoritative Directive

Description:	Sets whether authorization and authentication are passed to lower level modules
Syntax:	<code>AuthAuthoritative On Off</code>
Default:	<code>AuthAuthoritative On</code>
Context:	directory, .htaccess
Override:	AuthConfig
Status:	Base
Module:	mod_auth

Setting the [AUTHAUTHORITATIVE](#) directive explicitly to `Off` allows for both authentication and authorization to be passed on to lower level modules (as defined in the `modules.c` files) if there is **no** `userID` or `rule` matching the supplied `userID`. If there is a `userID` and/or rule specified; the usual password and access checks will be applied and a failure will give an "Authentication Required" reply.

So if a `userID` appears in the database of more than one module; or if a valid [REQUIRE](#) directive applies to more than one module; then the first module will verify the credentials; and no access is passed on; regardless of the [AUTHAUTHORITATIVE](#) setting.

A common use for this is in conjunction with one of the database modules; such as [MOD_AUTH_DBM](#), `mod_auth_mysql`, and [MOD_AUTH_ANON](#). These modules supply the bulk of the user credential checking; but a few (administrator) related accesses fall through to a lower level with a well protected [AUTHUSERFILE](#).

By default control is not passed on and an unknown `userID` or rule will result in an "Authentication Required" reply. Not setting it thus keeps the system secure and forces an NCSA compliant behaviour.



Security

Do consider the implications of allowing a user to allow fall-through in his `.htaccess` file; and verify that this is really what you want; Generally it is easier to just secure a single `.htpasswd` file, than it is to secure a database such as `mSQL`. Make sure that the `AUTHUSERFILE` and the `AUTHGROUPFILE` are stored outside the document tree of the web-server; do *not* put them in the directory that they protect. Otherwise, clients will be able to download the `AUTHUSERFILE` and the `AUTHGROUPFILE`.

AuthGroupFile Directive

Description:	Sets the name of a text file containing the list of user groups for authentication
Syntax:	<code>AuthGroupFile file-path</code>
Context:	directory, <code>.htaccess</code>
Override:	<code>AuthConfig</code>
Status:	Base
Module:	<code>mod_auth</code>

The `AUTHGROUPFILE` directive sets the name of a textual file containing the list of user groups for user authentication. File-path is the path to the group file. If it is not absolute, it is treated as relative to the `SERVERROOT`.

Each line of the group file contains a groupname followed by a colon, followed by the member usernames separated by spaces.

Example:

```
mygroup: bob joe anne
```

Note that searching large text files is *very* inefficient; `AUTHDBMGROUPFILE` provides a much better performance.



Security

Make sure that the `AUTHGROUPFILE` is stored outside the document tree of the web-server; do *not* put it in the directory that it protects. Otherwise, clients may be able to download the `AUTHGROUPFILE`.

AuthUserFile Directive

Description:	Sets the name of a text file containing the list of users and passwords for authentication
Syntax:	<code>AuthUserFile file-path</code>
Context:	directory, <code>.htaccess</code>
Override:	<code>AuthConfig</code>
Status:	Base
Module:	<code>mod_auth</code>

The `AUTHUSERFILE` directive sets the name of a textual file containing the list of users and passwords for user authentication. File-path is the path to the user file. If it is not absolute (*i.e.*, if it doesn't begin with a slash), it is treated as relative to the `SERVERROOT`.

Each line of the user file contains a username followed by a colon, followed by the encrypted password. If the same user ID is defined multiple times, `MOD_AUTH` will use the first occurrence to verify the password.

The utility `htpasswd` which is installed as part of the binary distribution, or which can be found in `src/support`, is used to maintain this password file. See the man page (p. 263) for more details. In short:

Create a password file `Filename` with `username` as the initial ID. It will prompt for the password:

```
htpasswd -c Filename username
```

Add or modify `username2` in the password file `Filename`:

```
htpasswd Filename username2
```

Note that searching large text files is *very* inefficient; [AUTHDBMUSERFILE](#) should be used instead.

**Security**

Make sure that the [AUTHUSERFILE](#) is stored outside the document tree of the web-server. Do **not** put it in the directory that it protects. Otherwise, clients may be able to download the [AUTHUSERFILE](#).

10.9 Apache Module `mod_auth_anon`

Description:	Allows "anonymous" user access to authenticated areas
Status:	Extension
ModuleIdentifier:	<code>auth_anon_module</code>
SourceFile:	<code>mod_auth_anon.c</code>
Compatibility:	Available only in versions prior to 2.1

Summary

This module does access control in a manner similar to anonymous-ftp sites; *i.e.* have a 'magic' user id 'anonymous' and the email address as a password. These email addresses can be logged.

Combined with other (database) access control methods, this allows for effective user tracking and customization according to a user profile while still keeping the site open for 'unregistered' users. One advantage of using Auth-based user tracking is that, unlike magic-cookies and funny URL pre/postfixes, it is completely browser independent and it allows users to share URLs.

Directives

- `Anonymous`
- `Anonymous_Authoritative`
- `Anonymous_LogEmail`
- `Anonymous_MustGiveEmail`
- `Anonymous_NoUserID`
- `Anonymous_VerifyEmail`

Example

The example below (when combined with the Auth directives of a `htpasswd`-file based (or GDM, mSQL etc.) base access control system allows users in as 'guests' with the following properties:

- It insists that the user enters a `userID`. (`Anonymous_NoUserID`)
- It insists that the user enters a password. (`Anonymous_MustGiveEmail`)
- The password entered must be a valid email address, *ie.* contain at least one '@' and a '.'. (`Anonymous_VerifyEmail`)
- The `userID` must be one of `anonymous guest www test welcome` and comparison is **not** case sensitive. (`Anonymous`)
- And the Email addresses entered in the `passwd` field are logged to the error log file. (`Anonymous_LogEmail`)

Excerpt of httpd.conf:

```

AnonymousNoUserID off
AnonymousMustGiveEmail on
AnonymousVerifyEmail on
AnonymousLogEmail on
Anonymous anonymous guest www test welcome

AuthName "Use 'anonymous' & Email address for guest entry"
AuthType basic

# An AuthUserFile/AuthDBUserFile/AuthDBMUserFile
# directive must be specified, or use
# AnonymousAuthoritative for public access.
# In the .htaccess for the public directory, add:
<Files *>
    Order Deny,Allow
    Allow from all
    Require valid-user
</Files>

```

Anonymous Directive

Description:	Specifies userIDs that are allowed access without password verification
Syntax:	Anonymous user [user] ...
Context:	directory, .htaccess
Override:	AuthConfig
Status:	Extension
Module:	mod_auth_anon

A list of one or more 'magic' userIDs which are allowed access without password verification. The userIDs are space separated. It is possible to use the ' and " quotes to allow a space in a userID as well as the \escape character.

Please note that the comparison is **case-IN-sensitive**.

I strongly suggest that the magic username 'anonymous' is always one of the allowed userIDs.

Example:

```
Anonymous anonymous "Not Registered" "I don't know"
```

This would allow the user to enter without password verification by using the userIDs "anonymous", "AnonyMous", "Not Registered" and "I Don't Know".

Anonymous Authoritative Directive

Description:	Configures if authorization will fall-through to other methods
Syntax:	Anonymous_Authoritative On Off
Default:	Anonymous_Authoritative Off
Context:	directory, .htaccess
Override:	AuthConfig
Status:	Extension
Module:	mod_auth_anon

When set On, there is no fall-through to other authentication methods. So if a userID does not match the values specified in the [ANONYMOUS](#) directive, access is denied.

Be sure you know what you are doing when you decide to switch it on. And remember that the order in which the Authentication modules are queried is defined in the `modules.c` files at compile time.

Anonymous_LogEmail Directive

Description:	Sets whether the password entered will be logged in the error log
Syntax:	<code>Anonymous_LogEmail On Off</code>
Default:	<code>Anonymous_LogEmail On</code>
Context:	directory, <code>.htaccess</code>
Override:	<code>AuthConfig</code>
Status:	Extension
Module:	<code>mod_auth_anon</code>

When set `On`, the default, the 'password' entered (which hopefully contains a sensible email address) is logged in the error log.

Anonymous_MustGiveEmail Directive

Description:	Specifies whether blank passwords are allowed
Syntax:	<code>Anonymous_MustGiveEmail On Off</code>
Default:	<code>Anonymous_MustGiveEmail On</code>
Context:	directory, <code>.htaccess</code>
Override:	<code>AuthConfig</code>
Status:	Extension
Module:	<code>mod_auth_anon</code>

Specifies whether the user must specify an email address as the password. This prohibits blank passwords.

Anonymous_NoUserID Directive

Description:	Sets whether the <code>userID</code> field may be empty
Syntax:	<code>Anonymous_NoUserID On Off</code>
Default:	<code>Anonymous_NoUserID Off</code>
Context:	directory, <code>.htaccess</code>
Override:	<code>AuthConfig</code>
Status:	Extension
Module:	<code>mod_auth_anon</code>

When set `On`, users can leave the `userID` (and perhaps the password field) empty. This can be very convenient for MS-Explorer users who can just hit return or click directly on the OK button; which seems a natural reaction.

Anonymous_VerifyEmail Directive

Description:	Sets whether to check the password field for a correctly formatted email address
Syntax:	<code>Anonymous_VerifyEmail On Off</code>
Default:	<code>Anonymous_VerifyEmail Off</code>
Context:	directory, <code>.htaccess</code>
Override:	<code>AuthConfig</code>
Status:	Extension
Module:	<code>mod_auth_anon</code>

When set `On` the 'password' entered is checked for at least one '@' and a '.' to encourage users to enter valid email addresses (see the above [ANONYMOUS_LOGEMAIL](#)).

10.10 Apache Module mod_auth_dbm

Description:	Provides for user authentication using DBM files
Status:	Extension
ModuleIdentifier:	auth_dbm_module
SourceFile:	mod_auth_dbm.c
Compatibility:	Available only in versions prior to 2.1

Summary

This module provides for HTTP Basic Authentication, where the usernames and passwords are stored in DBM type database files. It is an alternative to the plain text password files provided by [MOD_AUTH](#).

Directives

- [AuthDBMAuthoritative](#)
- [AuthDBMGroupFile](#)
- [AuthDBMType](#)
- [AuthDBMUserFile](#)

See also

- [AUTHNAME](#)
- [AUTHTYPE](#)
- [REQUIRE](#)
- [SATISFY](#)

AuthDBMAuthoritative Directive

Description:	Sets whether authentication and authorization will be passed on to lower level modules
Syntax:	<code>AuthDBMAuthoritative On Off</code>
Default:	<code>AuthDBMAuthoritative On</code>
Context:	directory, .htaccess
Override:	AuthConfig
Status:	Extension
Module:	mod_auth_dbm

Setting the [AUTHDBMAUTHORITATIVE](#) directive explicitly to `Off` allows for both authentication and authorization to be passed on to lower level modules (as defined in the `modules.c` files) if there is **no** `userID` or **rule** matching the supplied `userID`. If there is a `userID` and/or rule specified; the usual password and access checks will be applied and a failure will give an "Authentication Required" reply.

So if a `userID` appears in the database of more than one module; or if a valid [REQUIRE](#) directive applies to more than one module; then the first module will verify the credentials; and no access is passed on; regardless of the [AUTHDBMAUTHORITATIVE](#) setting.

A common use for this is in conjunction with one of the basic auth modules; such as [MOD_AUTH](#). Whereas this DBM module supplies the bulk of the user credential checking; a few (administrator) related accesses fall through to a lower level with a well protected `.htpasswd` file.

By default, control is not passed on and an unknown `userID` or rule will result in an "Authentication Required" reply. Not setting it thus keeps the system secure and forces an NCSA compliant behaviour.

**Security:**

Do consider the implications of allowing a user to allow fall-through in his `.htaccess` file; and verify that this is really what you want; Generally it is easier to just secure a single `.htpasswd` file, than it is to secure a database which might have more access interfaces.

AuthDBMGroupFile Directive

Description:	Sets the name of the database file containing the list of user groups for authentication
Syntax:	<code>AuthDBMGroupFile file-path</code>
Context:	directory, <code>.htaccess</code>
Override:	<code>AuthConfig</code>
Status:	Extension
Module:	<code>mod_auth_dbm</code>

The `AUTHDBMGROUPFILE` directive sets the name of a DBM file containing the list of user groups for user authentication. File-path is the absolute path to the group file.

The group file is keyed on the username. The value for a user is a comma-separated list of the groups to which the users belongs. There must be no whitespace within the value, and it must never contain any colons.

Security: make sure that the `AUTHDBMGROUPFILE` is stored outside the document tree of the web-server; do *not* put it in the directory that it protects. Otherwise, clients will be able to download the `AUTHDBMGROUPFILE` unless otherwise protected.

Combining Group and Password DBM files: In some cases it is easier to manage a single database which contains both the password and group details for each user. This simplifies any support programs that need to be written: they now only have to deal with writing to and locking a single DBM file. This can be accomplished by first setting the group and password files to point to the same DBM:

```
AuthDBMGroupFile /www/userbase
AuthDBMUserFile /www/userbase
```

The key for the single DBM is the username. The value consists of

```
Unix Crypt-ed Password:List of Groups[:(ignored)]
```

The password section contains the encrypted password as before. This is followed by a colon and the comma separated list of groups. Other data may optionally be left in the DBM file after another colon; it is ignored by the authentication module. This is what `www.telescope.org` uses for its combined password and group database.

AuthDBMType Directive

Description:	Sets the type of database file that is used to store passwords
Syntax:	<code>AuthDBMType default SDBM GDBM NDBM DB</code>
Default:	<code>AuthDBMType default</code>
Context:	directory, <code>.htaccess</code>
Override:	<code>AuthConfig</code>
Status:	Extension
Module:	<code>mod_auth_dbm</code>
Compatibility:	Available in version 2.0.30 and later.

Sets the type of database file that is used to store the passwords. The default database type is determined at compile time. The availability of other types of database files also depends on compile-time settings (p. 10).

It is crucial that whatever program you use to create your password files is configured to use the same type of database.

AuthDBMUserFile Directive

Description:	Sets the name of a database file containing the list of users and passwords for authentication
Syntax:	AuthDBMUserFile file-path
Context:	directory, .htaccess
Override:	AuthConfig
Status:	Extension
Module:	mod_auth_dbm

The [AUTHDBMUSERFILE](#) directive sets the name of a DBM file containing the list of users and passwords for user authentication. File-path is the absolute path to the user file.

The user file is keyed on the username. The value for a user is the encrypted password, optionally followed by a colon and arbitrary data. The colon and the data following it will be ignored by the server.



Security:

Make sure that the [AUTHDBMUSERFILE](#) is stored outside the document tree of the web-server; do *not* put it in the directory that it protects. Otherwise, clients will be able to download the [AUTHDBMUSERFILE](#).

Important compatibility note: The implementation of "dbmopen" in the apache modules reads the string length of the hashed values from the DBM data structures, rather than relying upon the string being NULL-appended. Some applications, such as the Netscape web server, rely upon the string being NULL-appended, so if you are having trouble using DBM files interchangeably between applications this may be a part of the problem.

A perl script called dbmmanage is included with Apache. This program can be used to create and update DBM format password files for use with this module.

10.11 Apache Module `mod_auth_digest`

Description:	User authentication using MD5 Digest Authentication.
Status:	Experimental
ModuleIdentifier:	<code>auth_digest_module</code>
SourceFile:	<code>mod_auth_digest.c</code>

Summary

This module implements HTTP Digest Authentication. However, it has not been extensively tested and is therefore marked experimental.

Directives

- `AuthDigestAlgorithm`
- `AuthDigestDomain`
- `AuthDigestFile`
- `AuthDigestGroupFile`
- `AuthDigestNcCheck`
- `AuthDigestNonceFormat`
- `AuthDigestNonceLifetime`
- `AuthDigestQop`
- `AuthDigestShmemSize`

See also

- [AUTHNAME](#)
- [AUTHTYPE](#)
- [REQUIRE](#)
- [SATISFY](#)

Using Digest Authentication

Using MD5 Digest authentication is very simple. Simply set up authentication normally, using `AuthType Digest` and `AUTHDIGESTFILE` instead of the normal `AuthType Basic` and `AUTHUSERFILE`; also, replace any `AUTHGROUPFILE` with `AUTHDIGESTGROUPFILE`. Then add a `AUTHDIGESTDOMAIN` directive containing at least the root URI(s) for this protection space.

Appropriate user (text) files can be created using the `htdigest` tool.

Example:

```
<Location /private/>
  AuthType Digest
  AuthName "private area"
  AuthDigestDomain /private/ http://mirror.my.dom/private2/
  AuthDigestFile /web/auth/.digest_pw
  Require valid-user
</Location>
```

⇒ Note

Digest authentication provides a more secure password system than Basic authentication, but only works with supporting browsers. As of November 2002, the major browsers that support digest authentication are Opera^a, MS Internet Explorer^b (fails when used with a query string - see "Working with MS Internet Explorer" below for a workaround), Amaya^c, Mozilla^d and Netscape^e since version 7. Since digest authentication is not as widely implemented as basic authentication, you should use it only in controlled environments.

^a<http://www.opera.com/>

^b<http://www.microsoft.com/windows/ie/>

^c<http://www.w3.org/Amaya/>

^d<http://www.mozilla.org>

^e<http://channels.netscape.com/ns/browsers/download.jsp>

Working with MS Internet Explorer

The Digest authentication implementation in previous Internet Explorer for Windows versions (5 and 6) had issues, namely that GET requests with a query string were not RFC compliant. There are a few ways to work around this issue.

The first way is to use POST requests instead of GET requests to pass data to your program. This method is the simplest approach if your application can work with this limitation.

Since version 2.0.51 Apache also provides a workaround in the `AuthDigestEnableQueryStringHack` environment variable. If `AuthDigestEnableQueryStringHack` is set for the request, Apache will take steps to work around the MSIE bug and remove the query string from the digest comparison. Using this method would look similar to the following.

Using Digest Authentication with MSIE:

```
BrowserMatch "MSIE" AuthDigestEnableQueryStringHack=On
```

This workaround is not necessary for MSIE 7, though enabling it does not cause any compatibility issues or significant overhead.

See the [BROWSERMATCH](#) directive for more details on conditionally setting environment variables

AuthDigestAlgorithm Directive

Description:	Selects the algorithm used to calculate the challenge and response hashes in digest authentication
Syntax:	<code>AuthDigestAlgorithm MD5 MD5-sess</code>
Default:	<code>AuthDigestAlgorithm MD5</code>
Context:	directory, .htaccess
Override:	AuthConfig
Status:	Experimental
Module:	mod_auth_digest

The [AUTHDIGESTALGORITHM](#) directive selects the algorithm used to calculate the challenge and response hashes.

⇒ MD5-sess is not correctly implemented yet.

AuthDigestDomain Directive

Description:	URIs that are in the same protection space for digest authentication
Syntax:	AuthDigestDomain URI [URI] ...
Context:	directory, .htaccess
Override:	AuthConfig
Status:	Experimental
Module:	mod_auth_digest

The [AUTHDIGESTDOMAIN](#) directive allows you to specify one or more URIs which are in the same protection space (*i.e.* use the same realm and username/password info). The specified URIs are prefixes, *i.e.* the client will assume that all URIs "below" these are also protected by the same username/password. The URIs may be either absolute URIs (*i.e.* including a scheme, host, port, etc) or relative URIs.

This directive *should* always be specified and contain at least the (set of) root URI(s) for this space. Omitting to do so will cause the client to send the Authorization header for *every request* sent to this server. Apart from increasing the size of the request, it may also have a detrimental effect on performance if [AUTHDIGESTNCHECK](#) is on.

The URIs specified can also point to different servers, in which case clients (which understand this) will then share username/password info across multiple servers without prompting the user each time.

AuthDigestFile Directive

Description:	Location of the text file containing the list of users and encoded passwords for digest authentication
Syntax:	AuthDigestFile file-path
Context:	directory, .htaccess
Override:	AuthConfig
Status:	Experimental
Module:	mod_auth_digest

The [AUTHDIGESTFILE](#) directive sets the name of a textual file containing the list of users and encoded passwords for digest authentication. File-path is the absolute path to the user file.

The digest file uses a special format. Files in this format can be created using the `htdigest` utility found in the `support/` subdirectory of the Apache distribution.

AuthDigestGroupFile Directive

Description:	Name of the text file containing the list of groups for digest authentication
Syntax:	AuthDigestGroupFile file-path
Context:	directory, .htaccess
Override:	AuthConfig
Status:	Experimental
Module:	mod_auth_digest

The [AUTHDIGESTGROUPFILE](#) directive sets the name of a textual file containing the list of groups and their members (user names). File-path is the absolute path to the group file.

Each line of the group file contains a groupname followed by a colon, followed by the member usernames separated by spaces. Example:

```
mygroup: bob joe anne
```

Note that searching large text files is *very* inefficient.

**Security:**

Make sure that the [AUTHGROUPFILE](#) is stored outside the document tree of the web-server; do *not* put it in the directory that it protects. Otherwise, clients may be able to download the [AUTHGROUPFILE](#).

AuthDigestNcCheck Directive

Description:	Enables or disables checking of the nonce-count sent by the server
Syntax:	AuthDigestNcCheck On Off
Default:	AuthDigestNcCheck Off
Context:	server config
Status:	Experimental
Module:	mod_auth_digest

⇒ Not implemented yet.

AuthDigestNonceFormat Directive

Description:	Determines how the nonce is generated
Syntax:	AuthDigestNonceFormat format
Context:	directory, .htaccess
Override:	AuthConfig
Status:	Experimental
Module:	mod_auth_digest

⇒ Not implemented yet.

AuthDigestNonceLifetime Directive

Description:	How long the server nonce is valid
Syntax:	AuthDigestNonceLifetime seconds
Default:	AuthDigestNonceLifetime 300
Context:	directory, .htaccess
Override:	AuthConfig
Status:	Experimental
Module:	mod_auth_digest

The [AUTHDIGESTNONCELIFETIME](#) directive controls how long the server nonce is valid. When the client contacts the server using an expired nonce the server will send back a 401 with `stale=true`. If `seconds` is greater than 0 then it specifies the amount of time for which the nonce is valid; this should probably never be set to less than 10 seconds. If `seconds` is less than 0 then the nonce never expires.

AuthDigestQop Directive

Description:	Determines the quality-of-protection to use in digest authentication
Syntax:	AuthDigestQop none auth auth-int [auth auth-int]
Default:	AuthDigestQop auth
Context:	directory, .htaccess
Override:	AuthConfig
Status:	Experimental
Module:	mod_auth_digest

The [AUTHDIGESTQOP](#) directive determines the quality-of-protection to use. `auth` will only do authentication (username/password); `auth-int` is authentication plus integrity checking (an MD5 hash of the entity is also computed and checked); `none` will cause the module to use the old RFC-2069 digest algorithm (which does not include integrity checking). Both `auth` and `auth-int` may be specified, in which the case the browser will choose which of these to use. `none` should only be used if the browser for some reason does not like the challenge it receives otherwise.

⇒ `auth-int` is not implemented yet.

AuthDigestShmemSize Directive

Description:	The amount of shared memory to allocate for keeping track of clients
Syntax:	AuthDigestShmemSize size
Default:	AuthDigestShmemSize 1000
Context:	server config
Status:	Experimental
Module:	mod_auth_digest

The [AUTHDIGESTSHMEMSIZE](#) directive defines the amount of shared memory, that will be allocated at the server startup for keeping track of clients. Note that the shared memory segment cannot be set less than the space that is necessary for tracking at least *one* client. This value is dependant on your system. If you want to find out the exact value, you may simply set [AUTHDIGESTSHMEMSIZE](#) to the value of 0 and read the error message after trying to start the server.

The size is normally expressed in Bytes, but you may let the number follow a `K` or an `M` to express your value as KBytes or MBytes. For example, the following directives are all equivalent:

```
AuthDigestShmemSize 1048576
AuthDigestShmemSize 1024K
AuthDigestShmemSize 1M
```

10.12 Apache Module mod_auth_ldap

Description:	Allows an LDAP directory to be used to store the database for HTTP Basic authentication.
Status:	Experimental
ModuleIdentifier:	auth_ldap_module
SourceFile:	mod_auth_ldap.c
Compatibility:	Available in version 2.0.41 and later

Summary

[MOD_AUTH_LDAP](#) supports the following features:

- Known to support the OpenLDAP SDK⁴ (both 1.x and 2.x), Novell LDAP SDK⁵ and the iPlanet (Netscape)⁶ SDK.
- Complex authorization policies can be implemented by representing the policy with LDAP filters.
- Support for Microsoft FrontPage allows FrontPage users to control access to their webs, while retaining LDAP for user authentication.
- Uses extensive caching of LDAP operations via mod_ldap (p. 465) .
- Support for LDAP over SSL (requires the Netscape SDK) or TLS (requires the OpenLDAP 2.x SDK or Novell LDAP SDK).

Directives

- AuthLDAPAuthoritative
- AuthLDAPBindDN
- AuthLDAPBindPassword
- AuthLDAPCharsetConfig
- AuthLDAPCompareDNOnServer
- AuthLDAPDereferenceAliases
- AuthLDAPEnabled
- AuthLDAPFrontPageHack
- AuthLDAPGroupAttribute
- AuthLDAPGroupAttributeIsDN
- AuthLDAPRemoteUserIsDN
- AuthLDAPUrl

See also

- [MOD_LDAP](#)

⁴<http://www.openldap.org/>

⁵<http://developer.novell.com/ndk/cldap.htm>

⁶<http://www.iplanet.com/downloads/developer/>

Contents

- Operation
 - The Authentication Phase
 - The Authorization Phase
- The Require Directives
 - Require valid-user
 - Require user
 - Require group
 - Require dn
 - Require ldap-attribute
- Examples
- Using TLS
- Using SSL
- Using Microsoft FrontPage with [MOD_AUTH_LDAP](#)
 - How It Works
 - Caveats

Operation

There are two phases in granting access to a user. The first phase is authentication, in which [MOD_AUTH_LDAP](#) verifies that the user's credentials are valid. This also called the *search/bind* phase. The second phase is authorization, in which [MOD_AUTH_LDAP](#) determines if the authenticated user is allowed access to the resource in question. This is also known as the *compare* phase.

The Authentication Phase

During the authentication phase, [MOD_AUTH_LDAP](#) searches for an entry in the directory that matches the username that the HTTP client passes. If a single unique match is found, then [MOD_AUTH_LDAP](#) attempts to bind to the directory server using the DN of the entry plus the password provided by the HTTP client. Because it does a search, then a bind, it is often referred to as the search/bind phase. Here are the steps taken during the search/bind phase.

1. Generate a search filter by combining the attribute and filter provided in the [AUTHLDAPURL](#) directive with the username passed by the HTTP client.
2. Search the directory using the generated filter. If the search does not return exactly one entry, deny or decline access.
3. Fetch the distinguished name of the entry retrieved from the search and attempt to bind to the LDAP server using the DN and the password passed by the HTTP client. If the bind is unsuccessful, deny or decline access.

The following directives are used during the search/bind phase

AUTHLDAPURL	Specifies the LDAP server, the base DN, the attribute to use in the search, as well as the extra search filter to use.
AUTHLDAPBINDDN	An optional DN to bind with during the search phase.
AUTHLDAPBINDPASSWORD	An optional password to bind with during the search phase.

The Authorization Phase

During the authorization phase, `MOD_AUTH_LDAP` attempts to determine if the user is authorized to access the resource. Many of these checks require `MOD_AUTH_LDAP` to do a compare operation on the LDAP server. This is why this phase is often referred to as the compare phase. `MOD_AUTH_LDAP` accepts the following `REQUIRE` directives to determine if the credentials are acceptable:

- Grant access if there is a `Require valid-user` directive.
- Grant access if there is a `Require user` directive, and the username in the directive matches the username passed by the client.
- Grant access if there is a `Require dn` directive, and the DN in the directive matches the DN fetched from the LDAP directory.
- Grant access if there is a `Require group` directive, and the DN fetched from the LDAP directory (or the username passed by the client) occurs in the LDAP group.
- Grant access if there is a `Require ldap-attribute` directive, and the attribute fetched from the LDAP directory matches the given value.
- otherwise, deny or decline access

`MOD_AUTH_LDAP` uses the following directives during the compare phase:

<code>AUTHLDAPURL</code>	The attribute specified in the URL is used in compare operations for the <code>Require user</code> operation.
<code>AUTHLDAPCOMPAREDNONSERVER</code>	Determines the behavior of the <code>Require dn</code> directive.
<code>AUTHLDAPGROUPATTRIBUTE</code>	Determines the attribute to use for comparisons in the <code>Require group</code> directive.
<code>AUTHLDAPGROUPATTRIBUTEISDN</code>	Specifies whether to use the user DN or the username when doing comparisons for the <code>Require group</code> directive.

The Require Directives

Apache's `REQUIRE` directives are used during the authorization phase to ensure that a user is allowed to access a resource.

Require valid-user

If this directive exists, `MOD_AUTH_LDAP` grants access to any user that has successfully authenticated during the search/bind phase.

Require user

The `Require user` directive specifies what usernames can access the resource. Once `MOD_AUTH_LDAP` has retrieved a unique DN from the directory, it does an LDAP compare operation using the username specified in the `Require user` to see if that username is part of the just-fetched LDAP entry. Multiple users can be granted access by putting multiple usernames on the line, separated with spaces. If a username has a space in it, then it must be surrounded with double quotes. Multiple users can also be granted access by using multiple `Require user` directives, with one user per line. For example, with a `AUTHLDAPURL` of `ldap://ldap/o=Airius?cn` (i.e., `cn` is used for searches), the following `Require` directives could be used to restrict access:

```
Require user "Barbara Jenson"
Require user "Fred User"
Require user "Joe Manager"
```

Because of the way that `MOD_AUTH_LDAP` handles this directive, Barbara Jenson could sign on as *Barbara Jenson*, *Babs Jenson* or any other `cn` that she has in her LDAP entry. Only the single `Require user` line is needed to support all values of the attribute in the user's entry.

If the `uid` attribute was used instead of the `cn` attribute in the URL above, the above three lines could be condensed to

```
Require user bjenson fuser jmanager
```

Require group

This directive specifies an LDAP group whose members are allowed access. It takes the distinguished name of the LDAP group. Note: Do not surround the group name with quotes. For example, assume that the following entry existed in the LDAP directory:

```
dn: cn=Administrators, o=Airius
objectClass: groupOfUniqueNames
uniqueMember: cn=Barbara Jenson, o=Airius
uniqueMember: cn=Fred User, o=Airius
```

The following directive would grant access to both Fred and Barbara:

```
Require group cn=Administrators, o=Airius
```

Behavior of this directive is modified by the `AUTHLDAPGROUPATTRIBUTE` and `AUTHLDAPGROUPATTRIBUTEISDN` directives.

Require dn

The `Require dn` directive allows the administrator to grant access based on distinguished names. It specifies a DN that must match for access to be granted. If the distinguished name that was retrieved from the directory server matches the distinguished name in the `Require dn`, then authorization is granted. Note: do not surround the distinguished name with quotes.

The following directive would grant access to a specific DN:

```
Require dn cn=Barbara Jenson, o=Airius
```

Behavior of this directive is modified by the `AUTHLDAPCOMPAREDNONSERVICES` directive.

Require ldap-attribute

The `Require ldap-attribute` directive allows the administrator to grant access based on attributes of the authenticated user in the LDAP directory. If the attribute in the directory matches the value given in the configuration, access is granted.

The following directive would grant access to anyone with the attribute `employeeType = active`

```
Require ldap-attribute employeeType=active
```

Multiple attribute/value pairs can be specified on the same line separated by spaces or they can be specified in multiple `Require ldap-attribute` directives. The effect of listing multiple attribute/values pairs is an OR operation. Access will be granted if any of the listed attribute values match the value of a corresponding attribute in the user object. If the value of the attribute contains a space, only the value must be within double quotes.

The following directive would grant access to anyone with the city attribute equal to "San Jose" or status equal to "Active"

```
Require ldap-attribute city="San Jose" status=active
```

Examples

- Grant access to anyone who exists in the LDAP directory, using their UID for searches.

```
AuthLDAPURL ldap://ldap1.airius.com:389/ou=People,
o=Airius?uid?sub?(objectClass=*)
Require valid-user
```

- The next example is the same as above; but with the fields that have useful defaults omitted. Also, note the use of a redundant LDAP server.

```
AuthLDAPURL ldap://ldap1.airius.com ldap2.airius.com/ou=People,
o=Airius
Require valid-user
```

- The next example is similar to the previous one, but it uses the common name instead of the UID. Note that this could be problematical if multiple people in the directory share the same `cn`, because a search on `cn` **must** return exactly one entry. That's why this approach is not recommended: it's a better idea to choose an attribute that is guaranteed unique in your directory, such as `uid`.

```
AuthLDAPURL ldap://ldap.airius.com/ou=People, o=Airius?cn
Require valid-user
```

- Grant access to anybody in the Administrators group. The users must authenticate using their UID.

```
AuthLDAPURL ldap://ldap.airius.com/o=Airius?uid
Require group cn=Administrators, o=Airius
```

- The next example assumes that everyone at Airius who carries an alphanumeric pager will have an LDAP attribute of `qpagePagerID`. The example will grant access only to people (authenticated via their UID) who have alphanumeric pagers:

```
AuthLDAPURL ldap://ldap.airius.com/o=Airius?uid??(qpagePagerID=*)
Require valid-user
```

- The next example demonstrates the power of using filters to accomplish complicated administrative requirements. Without filters, it would have been necessary to create a new LDAP group and ensure that the group's members remain synchronized with the pager users. This becomes trivial with filters. The goal is to grant access to anyone who has a filter, plus grant access to Joe Manager, who doesn't have a pager, but does need to access the same resource:

```
AuthLDAPURL
ldap://ldap.airius.com/o=Airius?uid??(|(qpagePagerID=*)(uid=jmanager))
Require valid-user
```

This last may look confusing at first, so it helps to evaluate what the search filter will look like based on who connects, as shown below. The text in blue is the part that is filled in using the attribute specified in the URL. The text in red is the part that is filled in using the filter specified in the URL. The text in green is filled in using the information that is retrieved from the HTTP client. If Fred User connects as `fuser`, the filter would look like

```
(&(|(qpagePagerID=*)(uid=jmanager))(uid=fuser))
```

The above search will only succeed if `fuser` has a pager. When Joe Manager connects as `jmanager`, the filter looks like

```
(&(|(qpagePagerID=*)(uid=jmanager))(uid=jmanager))
```

The above search will succeed whether `jmanager` has a pager or not.

Using TLS

To use TLS, see the `MOD_LDAP` directives `LDAPTRUSTEDCA` and `LDAPTRUSTEDCATYPE`.

Using SSL

To use SSL, see the `MOD_LDAP` directives `LDAPTRUSTEDCA` and `LDAPTRUSTEDCATYPE`.

To specify a secure LDAP server, use `ldaps://` in the `AUTHLDAPURL` directive, instead of `ldap://`.

Using Microsoft FrontPage with `mod_auth_ldap`

Normally, FrontPage uses FrontPage-web-specific user/group files (i.e., the `MOD_AUTH` module) to handle all authentication. Unfortunately, it is not possible to just change to LDAP authentication by adding the proper directives, because it will break the *Permissions* forms in the FrontPage client, which attempt to modify the standard text-based authorization files.

Once a FrontPage web has been created, adding LDAP authentication to it is a matter of adding the following directives to *every* `.htaccess` file that gets created in the web

```
AuthLDAPURL           "the url"
AuthLDAPAuthoritative off
AuthLDAPFrontPageHack on
```

`AUTHLDAPAUTHORITATIVE` must be off to allow `MOD_AUTH_LDAP` to decline group authentication so that Apache will fall back to file authentication for checking group membership. This allows the FrontPage-managed group file to be used.

How It Works

FrontPage restricts access to a web by adding the `Require valid-user` directive to the `.htaccess` files. If `AUTHLDAPFRONTPAGEHACK` is not on, the `Require valid-user` directive will succeed for any user who is valid *as far as LDAP is concerned*. This means that anybody who has an entry in the LDAP directory is considered a valid user, whereas FrontPage considers only those people in the local user file to be valid. The purpose of the hack is to force Apache to consult the local user file (which is managed by FrontPage) - instead of LDAP - when handling the `Require valid-user` directive.

Once directives have been added as specified above, FrontPage users will be able to perform all management operations from the FrontPage client.

Caveats

- When choosing the LDAP URL, the attribute to use for authentication should be something that will also be valid for putting into a `MOD_AUTH` user file. The user ID is ideal for this.
- When adding users via FrontPage, FrontPage administrators should choose usernames that already exist in the LDAP directory (for obvious reasons). Also, the password that the administrator enters into the form is ignored, since Apache will actually be authenticating against the password in the LDAP database, and not against the password in the local user file. This could cause confusion for web administrators.
- Apache must be compiled with `MOD_AUTH` in order to use FrontPage support. This is because Apache will still use the `MOD_AUTH` group file for determine the extent of a user's access to the FrontPage web.
- The directives must be put in the `.htaccess` files. Attempting to put them inside `<LOCATION>` or `<DIRECTORY>` directives won't work. This is because `MOD_AUTH_LDAP` has to be able to grab the `AUTHUSERFILE` directive that is found in FrontPage `.htaccess` files so that it knows where to look for the valid user list. If the `MOD_AUTH_LDAP` directives aren't in the same `.htaccess` file as the FrontPage directives, then the hack won't work, because `MOD_AUTH_LDAP` will never get a chance to process the `.htaccess` file, and won't be able to find the FrontPage-managed user file.

AuthLDAPAuthoritative Directive

Description:	Prevent other authentication modules from authenticating the user if this one fails
Syntax:	<code>AuthLDAPAuthoritative on off</code>
Default:	<code>AuthLDAPAuthoritative on</code>
Context:	directory, <code>.htaccess</code>
Override:	<code>AuthConfig</code>
Status:	Experimental
Module:	<code>mod_auth_ldap</code>

Set to `off` if this module should let other authentication modules attempt to authenticate the user, should authentication with this module fail. Control is only passed on to lower modules if there is no DN or rule that matches the supplied user name (as passed by the client).

AuthLDAPBindDN Directive

Description:	Optional DN to use in binding to the LDAP server
Syntax:	<code>AuthLDAPBindDN distinguished-name</code>
Context:	directory, <code>.htaccess</code>
Override:	<code>AuthConfig</code>
Status:	Experimental
Module:	<code>mod_auth_ldap</code>

An optional DN used to bind to the server when searching for entries. If not provided, `MOD_AUTH_LDAP` will use an anonymous bind.

AuthLDAPBindPassword Directive

Description:	Password used in conjunction with the bind DN
Syntax:	<code>AuthLDAPBindPassword password</code>
Context:	directory, <code>.htaccess</code>
Override:	<code>AuthConfig</code>
Status:	Experimental
Module:	<code>mod_auth_ldap</code>

A bind password to use in conjunction with the bind DN. Note that the bind password is probably sensitive data, and should be properly protected. You should only use the `AUTHLDAPBINDDN` and `AUTHLDAPBINDPASSWORD` if you absolutely need them to search the directory.

AuthLDAPCharsetConfig Directive

Description:	Language to charset conversion configuration file
Syntax:	<code>AuthLDAPCharsetConfig file-path</code>
Context:	server config
Status:	Experimental
Module:	<code>mod_auth_ldap</code>

The `AUTHLDAPCHARSETCONFIG` directive sets the location of the language to charset conversion configuration file. File-path is relative to the `SERVERROOT`. This file specifies the list of language extensions to character sets. Most administrators use the provided `charset.conv` file, which associates common language extensions to character sets.

The file contains lines in the following format:

```
Language-Extension charset [Language-String] ...
```

The case of the extension does not matter. Blank lines, and lines beginning with a hash character (`#`) are ignored.

AuthLDAPCompareDNOnServer Directive

Description:	Use the LDAP server to compare the DN's
Syntax:	<code>AuthLDAPCompareDNOnServer on off</code>
Default:	<code>AuthLDAPCompareDNOnServer on</code>
Context:	directory, <code>.htaccess</code>
Override:	<code>AuthConfig</code>
Status:	Experimental
Module:	<code>mod_auth_ldap</code>

When set, `MOD_AUTH_LDAP` will use the LDAP server to compare the DN's. This is the only foolproof way to compare DN's. `MOD_AUTH_LDAP` will search the directory for the DN specified with the `Require dn` directive, then, retrieve the DN and compare it with the DN retrieved from the user entry. If this directive is not set, `MOD_AUTH_LDAP` simply does a string comparison. It is possible to get false negatives with this approach, but it is much faster. Note the `MOD_LDAP` cache can speed up DN comparison in most situations.

AuthLDAPDereferenceAliases Directive

Description:	When will the module de-reference aliases
Syntax:	AuthLDAPDereferenceAliases never searching finding always
Default:	AuthLDAPDereferenceAliases Always
Context:	directory, .htaccess
Override:	AuthConfig
Status:	Experimental
Module:	mod_auth_ldap

This directive specifies when [MOD_AUTH_LDAP](#) will de-reference aliases during LDAP operations. The default is `always`.

AuthLDAPEnabled Directive

Description:	Turn on or off LDAP authentication
Syntax:	AuthLDAPEnabled on off
Default:	AuthLDAPEnabled on
Context:	directory, .htaccess
Override:	AuthConfig
Status:	Experimental
Module:	mod_auth_ldap

Set to `off` to disable [MOD_AUTH_LDAP](#) in certain directories. This is useful if you have [MOD_AUTH_LDAP](#) enabled at or near the top of your tree, but want to disable it completely in certain locations.

AuthLDAPFrontPageHack Directive

Description:	Allow LDAP authentication to work with MS FrontPage
Syntax:	AuthLDAPFrontPageHack on off
Default:	AuthLDAPFrontPageHack off
Context:	directory, .htaccess
Override:	AuthConfig
Status:	Experimental
Module:	mod_auth_ldap

See the section on using Microsoft FrontPage with [MOD_AUTH_LDAP](#).

AuthLDAPGroupAttribute Directive

Description:	LDAP attributes used to check for group membership
Syntax:	AuthLDAPGroupAttribute <i>attribute</i>
Context:	directory, .htaccess
Override:	AuthConfig
Status:	Experimental
Module:	mod_auth_ldap

This directive specifies which LDAP attributes are used to check for group membership. Multiple attributes can be used by specifying this directive multiple times. If not specified, then [MOD_AUTH_LDAP](#) uses the `member` and `uniquemember` attributes.

AuthLDAPGroupAttributeIsDN Directive

Description:	Use the DN of the client username when checking for group membership
Syntax:	AuthLDAPGroupAttributeIsDN on off
Default:	AuthLDAPGroupAttributeIsDN on
Context:	directory, .htaccess
Override:	AuthConfig
Status:	Experimental
Module:	mod_auth_ldap

When set `on`, this directive says to use the distinguished name of the client username when checking for group membership. Otherwise, the username will be used. For example, assume that the client sent the username `bjenson`, which corresponds to the LDAP DN `cn=Babs Jenson, o=Airius`. If this directive is set, `MOD_AUTH_LDAP` will check if the group has `cn=Babs Jenson, o=Airius` as a member. If this directive is not set, then `MOD_AUTH_LDAP` will check if the group has `bjenson` as a member.

AuthLDAPRemoteUserIsDN Directive

Description:	Use the DN of the client username to set the <code>REMOTE_USER</code> environment variable
Syntax:	AuthLDAPRemoteUserIsDN on off
Default:	AuthLDAPRemoteUserIsDN off
Context:	directory, .htaccess
Override:	AuthConfig
Status:	Experimental
Module:	mod_auth_ldap

If this directive is set to `on`, the value of the `REMOTE_USER` environment variable will be set to the full distinguished name of the authenticated user, rather than just the username that was passed by the client. It is turned off by default.

AuthLDAPUrl Directive

Description:	URL specifying the LDAP search parameters
Syntax:	AuthLDAPUrl <i>url</i>
Context:	directory, .htaccess
Override:	AuthConfig
Status:	Experimental
Module:	mod_auth_ldap

An RFC 2255 URL which specifies the LDAP search parameters to use. The syntax of the URL is

```
ldap://host:port/basedn?attribute?scope?filter
```

ldap For regular ldap, use the string `ldap`. For secure LDAP, use `ldaps` instead. Secure LDAP is only available if Apache was linked to an LDAP library with SSL support.

host:port The name/port of the ldap server (defaults to `localhost:389` for `ldap`, and `localhost:636` for `ldaps`). To specify multiple, redundant LDAP servers, just list all servers, separated by spaces. `MOD_AUTH_LDAP` will try connecting to each server in turn, until it makes a successful connection.

Once a connection has been made to a server, that connection remains active for the life of the `httpd` process, or until the LDAP server goes down.

If the LDAP server goes down and breaks an existing connection, `MOD_AUTH_LDAP` will attempt to re-connect, starting with the primary server, and trying each redundant server in turn. Note that this is different than a true round-robin search.

basedn The DN of the branch of the directory where all searches should start from. At the very least, this must be the top of your directory tree, but could also specify a subtree in the directory.

attribute The attribute to search for. Although RFC 2255 allows a comma-separated list of attributes, only the first attribute will be used, no matter how many are provided. If no attributes are provided, the default is to use `uid`. It's a good idea to choose an attribute that will be unique across all entries in the subtree you will be using.

scope The scope of the search. Can be either `one` or `sub`. Note that a scope of `base` is also supported by RFC 2255, but is not supported by this module. If the scope is not provided, or if `base` scope is specified, the default is to use a scope of `sub`.

filter A valid LDAP search filter. If not provided, defaults to `(objectClass=*)`, which will search for all objects in the tree. Filters are limited to approximately 8000 characters (the definition of `MAX_STRING_LEN` in the Apache source code). This should be than sufficient for any application.

When doing searches, the attribute, filter and username passed by the HTTP client are combined to create a search filter that looks like `(&(filter)(attribute=username))`.

For example, consider an URL of `ldap://ldap.airius.com/o=Airius?cn?sub?(posixid=*)`. When a client attempts to connect using a username of Babs Jenson, the resulting search filter will be `(&(posixid=*)(cn=Babs Jenson))`.

See above for examples of [AUTHLDAPURL](#) URLs.

10.13 Apache Module `mod_autoindex`

Description:	Generates directory indexes, automatically, similar to the Unix <code>ls</code> command or the Win32 <code>dir</code> shell command
Status:	Base
ModuleIdentifier:	<code>autoindex_module</code>
SourceFile:	<code>mod_autoindex.c</code>

Summary

The index of a directory can come from one of two sources:

- A file written by the user, typically called `index.html`. The `DIRECTORYINDEX` directive sets the name of this file. This is controlled by `MOD_DIR`.
- Otherwise, a listing generated by the server. The other directives control the format of this listing. The `ADDICON`, `ADDICONBYENCODING` and `ADDICONBYTYPE` are used to set a list of icons to display for various file types; for each file listed, the first icon listed that matches the file is displayed. These are controlled by `MOD_AUTOINDEX`.

The two functions are separated so that you can completely remove (or replace) automatic index generation should you want to.

Automatic index generation is enabled with using `Options +Indexes`. See the `OPTIONS` directive for more details.

If the `FancyIndexing` option is given with the `INDEXOPTIONS` directive, the column headers are links that control the order of the display. If you select a header link, the listing will be regenerated, sorted by the values in that column. Selecting the same header repeatedly toggles between ascending and descending order. These column header links are suppressed with `INDEXOPTIONS` directive's `SuppressColumnSorting` option.

Note that when the display is sorted by "Size", it's the *actual* size of the files that's used, not the displayed value - so a 1010-byte file will always be displayed before a 1011-byte file (if in ascending order) even though they both are shown as "1K".

Directives

- `AddAlt`
- `AddAltByEncoding`
- `AddAltByType`
- `AddDescription`
- `AddIcon`
- `AddIconByEncoding`
- `AddIconByType`
- `DefaultIcon`
- `HeaderName`
- `IndexIgnore`
- `IndexOptions`
- `IndexOrderDefault`
- `ReadmeName`

Autoindex Request Query Arguments

Apache 2.0.23 reorganized the Query Arguments for Column Sorting, and introduced an entire group of new query options. To effectively eliminate all client control over the output, the `IndexOptions IgnoreClient` option was introduced.

The column sorting headers themselves are self-referencing hyperlinks that add the sort query options shown below. Any option below may be added to any request for the directory resource.

- `C=N` sorts the directory by file name
- `C=M` sorts the directory by last-modified date, then file name
- `C=S` sorts the directory by size, then file name
- `C=D` sorts the directory by description, then file name
- `O=A` sorts the listing in Ascending Order
- `O=D` sorts the listing in Descending Order
- `F=0` formats the listing as a simple list (not FancyIndexed)
- `F=1` formats the listing as a FancyIndexed list
- `F=2` formats the listing as an HTMLTable FancyIndexed list
- `V=0` disables version sorting
- `V=1` enables version sorting
- `P=pattern` lists only files matching the given pattern

Note that the 'P'attern query argument is tested *after* the usual `INDEXIGNORE` directives are processed, and all file names are still subjected to the same criteria as any other autoindex listing. The Query Arguments parser in `MOD_AUTOINDEX` will stop abruptly when an unrecognized option is encountered. The Query Arguments must be well formed, according to the table above.

The simple example below, which can be clipped and saved in a `header.html` file, illustrates these query options. Note that the unknown "X" argument, for the submit button, is listed last to assure the arguments are all parsed before `mod_autoindex` encounters the `X=Go` input.

```

<form action="" method="get">
  Show me a <select name="F">
    <option value="0"> Plain list</option>
    <option value="1" selected="selected"> Fancy list</option>
    <option value="2"> Table list</option>
  </select>
  Sorted by <select name="C">
    <option value="N" selected="selected"> Name</option>
    <option value="M"> Date Modified</option>
    <option value="S"> Size</option>
    <option value="D"> Description</option>
  </select>
  <select name="O">
    <option value="A" selected="selected"> Ascending</option>
    <option value="D"> Descending</option>
  </select>
  <select name="V">
    <option value="0" selected="selected"> in Normal
    order</option>
    <option value="1"> in Version order</option>
  </select>
  Matching <input type="text" name="P" value="*" />
  <input type="submit" name="X" value="Go" />
</form>

```

AddAlt Directive

Description:	Alternate text to display for a file, instead of an icon selected by filename
Syntax:	AddAlt string file [file] ...
Context:	server config, virtual host, directory, .htaccess
Override:	Indexes
Status:	Base
Module:	mod_autoindex

ADDALT provides the alternate text to display for a file, instead of an icon, for FancyIndexing. File is a file extension, partial filename, wild-card expression or full filename for files to describe. If String contains any whitespace, you have to enclose it in quotes (" or '). This alternate text is displayed if the client is image-incapable, has image loading disabled, or fails to retrieve the icon.

Examples

```

AddAlt "PDF file" *.pdf
AddAlt Compressed *.gz *.zip *.Z

```

AddAltByEncoding Directive

Description:	Alternate text to display for a file instead of an icon selected by MIME-encoding
Syntax:	<code>AddAltByEncoding string MIME-encoding [MIME-encoding] ...</code>
Context:	server config, virtual host, directory, .htaccess
Override:	Indexes
Status:	Base
Module:	mod_autoindex

ADDALTBYPENCODING provides the alternate text to display for a file, instead of an icon, for `FancyIndexing`. MIME-encoding is a valid content-encoding, such as `x-compress`. If `String` contains any whitespace, you have to enclose it in quotes (`"` or `'`). This alternate text is displayed if the client is image-incapable, has image loading disabled, or fails to retrieve the icon.

Example

```
AddAltByEncoding gzip x-gzip
```

AddAltByType Directive

Description:	Alternate text to display for a file, instead of an icon selected by MIME content-type
Syntax:	<code>AddAltByType string MIME-type [MIME-type] ...</code>
Context:	server config, virtual host, directory, .htaccess
Override:	Indexes
Status:	Base
Module:	mod_autoindex

ADDALTBYPETYPE sets the alternate text to display for a file, instead of an icon, for `FancyIndexing`. MIME-type is a valid content-type, such as `text/html`. If `String` contains any whitespace, you have to enclose it in quotes (`"` or `'`). This alternate text is displayed if the client is image-incapable, has image loading disabled, or fails to retrieve the icon.

Example

```
AddAltByType 'plain text' text/plain
```

AddDescription Directive

Description:	Description to display for a file
Syntax:	<code>AddDescription string file [file] ...</code>
Context:	server config, virtual host, directory, .htaccess
Override:	Indexes
Status:	Base
Module:	mod_autoindex

This sets the description to display for a file, for `FancyIndexing`. `File` is a file extension, partial filename, wild-card expression or full filename for files to describe. `String` is enclosed in double quotes (`"`).

Example

```
AddDescription "The planet Mars" /web/pics/mars.gif
```

The typical, default description field is 23 bytes wide. 6 more bytes are added by the `IndexOptions SuppressIcon` option, 7 bytes are added by the `IndexOptions SuppressSize` option, and 19 bytes are added by the `IndexOptions SuppressLastModified` option. Therefore, the widest default the description column is ever assigned is 55 bytes.

See the `DescriptionWidth` [INDEXOPTIONS](#) keyword for details on overriding the size of this column, or allowing descriptions of unlimited length.

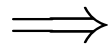

Caution

Descriptive text defined with [ADDDescription](#) may contain HTML markup, such as tags and character entities. If the width of the description column should happen to truncate a tagged element (such as cutting off the end of a bolded phrase), the results may affect the rest of the directory listing.

AddIcon Directive

Description:	Icon to display for a file selected by name
Syntax:	<code>AddIcon icon name [name] ...</code>
Context:	server config, virtual host, directory, <code>.htaccess</code>
Override:	Indexes
Status:	Base
Module:	<code>mod_autoindex</code>

This sets the icon to display next to a file ending in name for `FancyIndexing`. `Icon` is either a (%-escaped) relative URL to the icon, or of the format `(alttext,url)` where `alttext` is the text tag given for an icon for non-graphical browsers.

`Name` is either `^^DIRECTORY^^` for directories, `^^BLANKICON^^` for blank lines (to format the list correctly), a file extension, a wildcard expression, a partial filename or a complete filename.

Examples

```
AddIcon (IMG,/icons/image.xbm) .gif .jpg .xbm
AddIcon /icons/dir.xbm ^^DIRECTORY^^
AddIcon /icons/backup.xbm *~
```

[ADDICONBYTYPE](#) should be used in preference to [ADDICON](#), when possible.

AddIconByEncoding Directive

Description:	Icon to display next to files selected by MIME content-encoding
Syntax:	<code>AddIconByEncoding icon MIME-encoding [MIME-encoding] ...</code>
Context:	server config, virtual host, directory, <code>.htaccess</code>
Override:	Indexes
Status:	Base
Module:	<code>mod_autoindex</code>

This sets the icon to display next to files with `FancyIndexing`. `Icon` is either a (%-escaped) relative URL to the icon, or of the format `(alttext,url)` where `alttext` is the text tag given for an icon for non-graphical browsers.

MIME-encoding is a wildcard expression matching required the content-encoding.

Example

```
AddIconByEncoding /icons/compress.xbm x-compress
```

AddIconByType Directive

Description:	Icon to display next to files selected by MIME content-type
Syntax:	AddIconByType icon MIME-type [MIME-type] ...
Context:	server config, virtual host, directory, .htaccess
Override:	Indexes
Status:	Base
Module:	mod_autoindex

This sets the icon to display next to files of type MIME-type for `FancyIndexing`. Icon is either a (%-escaped) relative URL to the icon, or of the format `(alttext,url)` where `alttext` is the text tag given for an icon for non-graphical browsers.

MIME-type is a wildcard expression matching required the mime types.

Example

```
AddIconByType (IMG,/icons/image.xbm) image/*
```

DefaultIcon Directive

Description:	Icon to display for files when no specific icon is configured
Syntax:	DefaultIcon url-path
Context:	server config, virtual host, directory, .htaccess
Override:	Indexes
Status:	Base
Module:	mod_autoindex

The `DEFAULTICON` directive sets the icon to display for files when no specific icon is known, for `FancyIndexing`. `Url-path` is a (%-escaped) relative URL to the icon.

Example

```
DefaultIcon /icon/unknown.xbm
```

HeaderName Directive

Description:	Name of the file that will be inserted at the top of the index listing
Syntax:	HeaderName filename
Context:	server config, virtual host, directory, .htaccess
Override:	Indexes
Status:	Base
Module:	mod_autoindex

The `HEADERNAME` directive sets the name of the file that will be inserted at the top of the index listing. `Filename` is the name of the file to include.

Example

```
HeaderName HEADER.html
```

⇒ Both `HeaderName` and `READMEName` now treat `Filename` as a URI path relative to the one used to access the directory being indexed. If `Filename` begins with a slash, it will be taken to be relative to the `DOCUMENTROOT`.

Example

```
HeaderName /include/HEADER.html
```

`Filename` must resolve to a document with a major content type of `text/*` (e.g., `text/html`, `text/plain`, etc.). This means that filename may refer to a CGI script if the script's actual file type (as opposed to its output) is marked as `text/html` such as with a directive like:

```
AddType text/html .cgi
```

Content negotiation (p. 47) will be performed if `OPTIONS MultiViews` is in effect. If filename resolves to a static `text/html` document (not a CGI script) and either one of the `OPTIONS Includes` or `IncludesNOEXEC` is enabled, the file will be processed for server-side includes (see the `MOD_INCLUDE` documentation).

If the file specified by `HEADERNAME` contains the beginnings of an HTML document (`<html>`, `<head>`, etc.) then you will probably want to set `IndexOptions +SuppressHTMLPreamble`, so that these tags are not repeated.

IndexIgnore Directive

Description:	Adds to the list of files to hide when listing a directory
Syntax:	<code>IndexIgnore file [file] ...</code>
Context:	server config, virtual host, directory, <code>.htaccess</code>
Override:	Indexes
Status:	Base
Module:	<code>mod_autoindex</code>

The `INDEXIGNORE` directive adds to the list of files to hide when listing a directory. `File` is a shell-style wildcard expression or full filename. Multiple `IndexIgnore` directives add to the list, rather than the replacing the list of ignored files. By default, the list contains `.` (the current directory).

```
IndexIgnore README .htaccess *.bak *~
```

IndexOptions Directive

Description:	Various configuration settings for directory indexing
Syntax:	<code>IndexOptions [+ -]option [[+ -]option] ...</code>
Context:	server config, virtual host, directory, <code>.htaccess</code>
Override:	Indexes
Status:	Base
Module:	<code>mod_autoindex</code>

The `INDEXOPTIONS` directive specifies the behavior of the directory indexing. `Option` can be one of

Charset=character-set (*Apache 2.0.61 and later*) The `Charset` keyword allows you to specify the character set of the generated page. The default is either ISO-8859-1 or UTF-8, depending on whether the underlying file system is unicode or not.

Example:

```
IndexOptions Charset=UTF-8
```

Type=MIME content-type (*Apache 2.0.61 and later*) The `Type` keyword allows you to specify the MIME content-type of the generated page. The default is `text/html`.

Example:

```
IndexOptions Type=text/plain
```

DescriptionWidth=[n — *] (*Apache 2.0.23 and later*) The `DescriptionWidth` keyword allows you to specify the width of the description column in characters.

`-DescriptionWidth` (or `unset`) allows [MOD_AUTOINDEX](#) to calculate the best width.

`DescriptionWidth=n` fixes the column width to `n` bytes wide.

`DescriptionWidth=*` grows the column to the width necessary to accommodate the longest description string.

See the section on [ADDDescription](#) for dangers inherent in truncating descriptions.

FancyIndexing This turns on fancy indexing of directories.

FoldersFirst (*Apache 2.0.23 and later*) If this option is enabled, subdirectory listings will *always* appear first, followed by normal files in the directory. The listing is basically broken into two components, the files and the subdirectories, and each is sorted separately and then displayed subdirectories-first. For instance, if the sort order is descending by name, and `FoldersFirst` is enabled, subdirectory `Zed` will be listed before subdirectory `Beta`, which will be listed before normal files `Gamma` and `Alpha`. **This option only has an effect if `FancyIndexing` is also enabled.**

HTMLTable (*Experimental, Apache 2.0.23 and later*) This experimental option with `FancyIndexing` constructs a simple table for the fancy directory listing. Note this will confuse older browsers. It is particularly necessary if file names or description text will alternate between left-to-right and right-to-left reading order, as can happen on WinNT or other utf-8 enabled platforms.

IconsAreLinks This makes the icons part of the anchor for the filename, for fancy indexing.

IconHeight[=pixels] Presence of this option, when used with `IconWidth`, will cause the server to include `height` and `width` attributes in the `img` tag for the file icon. This allows browser to precalculate the page layout without having to wait until all the images have been loaded. If no value is given for the option, it defaults to the standard height of the icons supplied with the Apache software.

IconWidth[=pixels] Presence of this option, when used with `IconHeight`, will cause the server to include `height` and `width` attributes in the `img` tag for the file icon. This allows browser to precalculate the page layout without having to wait until all the images have been loaded. If no value is given for the option, it defaults to the standard width of the icons supplied with the Apache software.

IgnoreCase If this option is enabled, names are sorted in a case-insensitive manner. For instance, if the sort order is ascending by name, and `IgnoreCase` is enabled, file `Zeta` will be listed after file `alfa` (Note: file `GAMMA` will always be listed before file `gamma`).

IgnoreClient This option causes [MOD_AUTOINDEX](#) to ignore all query variables from the client, including sort order (implies `SuppressColumnSorting`.)

NameWidth=[n — *] The `NameWidth` keyword allows you to specify the width of the filename column in bytes.

`-NameWidth` (or `unset`) allows [MOD_AUTOINDEX](#) to calculate the best width.

`NameWidth=n` fixes the column width to `n` bytes wide.

`NameWidth=*` grows the column to the necessary width.

ScanHTMLTitles This enables the extraction of the title from HTML documents for fancy indexing. If the file does not have a description given by `ADDDescription` then httpd will read the document for the value of the `title` element. This is CPU and disk intensive.

SuppressColumnSorting If specified, Apache will not make the column headings in a FancyIndexed directory listing into links for sorting. The default behavior is for them to be links; selecting the column heading will sort the directory listing by the values in that column. **Prior to Apache 2.0.23, this also disabled parsing the Query Arguments for the sort string.** That behavior is now controlled by `IndexOptions IgnoreClient` in Apache 2.0.23.

SuppressDescription This will suppress the file description in fancy indexing listings. By default, no file descriptions are defined, and so the use of this option will regain 23 characters of screen space to use for something else. See `ADDDescription` for information about setting the file description. See also the `DescriptionWidth` index option to limit the size of the description column.

SuppressHTMLPreamble If the directory actually contains a file specified by the `HEADERNAME` directive, the module usually includes the contents of the file after a standard HTML preamble (`<html>`, `<head>`, *et cetera*). The `SuppressHTMLPreamble` option disables this behaviour, causing the module to start the display with the header file contents. The header file must contain appropriate HTML instructions in this case. If there is no header file, the preamble is generated as usual.

SuppressIcon (Apache 2.0.23 and later) This will suppress the icon in fancy indexing listings. Combining both `SuppressIcon` and `SuppressRules` yields proper HTML 3.2 output, which by the final specification prohibits `img` and `hr` elements from the `pre` block (used to format FancyIndexed listings.)

SuppressLastModified This will suppress the display of the last modification date, in fancy indexing listings.

SuppressRules (Apache 2.0.23 and later) This will suppress the horizontal rule lines (`hr` elements) in directory listings. Combining both `SuppressIcon` and `SuppressRules` yields proper HTML 3.2 output, which by the final specification prohibits `img` and `hr` elements from the `pre` block (used to format FancyIndexed listings.)

SuppressSize This will suppress the file size in fancy indexing listings.

TrackModified (Apache 2.0.23 and later) This returns the Last-Modified and ETag values for the listed directory in the HTTP header. It is only valid if the operating system and file system return appropriate `stat()` results. Some Unix systems do so, as do OS2's JFS and Win32's NTFS volumes. OS2 and Win32 FAT volumes, for example, do not. Once this feature is enabled, the client or proxy can track changes to the list of files when they perform a HEAD request. Note some operating systems correctly track new and removed files, but do not track changes for sizes or dates of the files within the directory. **Changes to the size or date stamp of an existing file will not update the Last-Modified header on all Unix platforms.** If this is a concern, leave this option disabled.

VersionSort (Apache 2.0a3 and later) The `VersionSort` keyword causes files containing version numbers to sort in a natural way. Strings are sorted as usual, except that substrings of digits in the name and description are compared according to their numeric value.

Example:

```
foo-1.7
foo-1.7.2
foo-1.7.12
foo-1.8.2
foo-1.8.2a
foo-1.12
```

If the number starts with a zero, then it is considered to be a fraction:

```
foo-1.001
foo-1.002
foo-1.030
foo-1.04
```

XHTML (*Apache 2.0.49 and later*) The XHTML keyword forces `MOD_AUTOINDEX` to emit XHTML 1.0 code instead of HTML 3.2.

Incremental IndexOptions Apache 1.3.3 introduced some significant changes in the handling of `INDEXOPTIONS` directives. In particular:

- Multiple `INDEXOPTIONS` directives for a single directory are now merged together. The result of:

```
<Directory /foo>
  IndexOptions HTMLTable
  IndexOptions SuppressColumnsorting
</Directory>
```

will be the equivalent of

```
IndexOptions HTMLTable SuppressColumnsorting
```

- The addition of the incremental syntax (*i.e.*, prefixing keywords with + or -).

Whenever a '+' or '-' prefixed keyword is encountered, it is applied to the current `INDEXOPTIONS` settings (which may have been inherited from an upper-level directory). However, whenever an unprefixed keyword is processed, it clears all inherited options and any incremental settings encountered so far. Consider the following example:

```
IndexOptions +ScanHTMLTitles -IconsAreLinks FancyIndexing
IndexOptions +SuppressSize
```

The net effect is equivalent to `IndexOptions FancyIndexing +SuppressSize`, because the unprefixed `FancyIndexing` discarded the incremental keywords before it, but allowed them to start accumulating again afterward.

To unconditionally set the `INDEXOPTIONS` for a particular directory, clearing the inherited settings, specify keywords without any + or - prefixes.

IndexOrderDefault Directive

Description:	Sets the default ordering of the directory index
Syntax:	<code>IndexOrderDefault Ascending Descending Name Date Size Description</code>
Default:	<code>IndexOrderDefault Ascending Name</code>
Context:	server config, virtual host, directory, <code>.htaccess</code>
Override:	Indexes
Status:	Base
Module:	<code>mod_autoindex</code>

The `INDEXORDERDEFAULT` directive is used in combination with the `FancyIndexing` index option. By default, fancyindexed directory listings are displayed in ascending order by filename; the `INDEXORDERDEFAULT` allows you to change this initial display order.

[INDEXORDERDEFAULT](#) takes two arguments. The first must be either `Ascending` or `Descending`, indicating the direction of the sort. The second argument must be one of the keywords `Name`, `Date`, `Size`, or `Description`, and identifies the primary key. The secondary key is *always* the ascending filename.

You can force a directory listing to only be displayed in a particular order by combining this directive with the `SuppressColumnSorting` index option; this will prevent the client from requesting the directory listing in a different order.

ReadmeName Directive

Description:	Name of the file that will be inserted at the end of the index listing
Syntax:	<code>ReadmeName filename</code>
Context:	server config, virtual host, directory, <code>.htaccess</code>
Override:	Indexes
Status:	Base
Module:	<code>mod_autoindex</code>

The [READMEName](#) directive sets the name of the file that will be appended to the end of the index listing. `Filename` is the name of the file to include, and is taken to be relative to the location being indexed. If `Filename` begins with a slash, it will be taken to be relative to the [DOCUMENTROOT](#).

Example

```
ReadmeName FOOTER.html
```

Example 2

```
ReadmeName /include/FOOTER.html
```

See also [HEADERNAME](#), where this behavior is described in greater detail.

10.14 Apache Module mod_cache

Description:	Content cache keyed to URIs.
Status:	Experimental
ModuleIdentifier:	cache_module
SourceFile:	mod_cache.c

Summary



This module is experimental. Documentation is still under development...

MOD_CACHE implements an RFC 2616⁷ compliant HTTP content cache that can be used to cache either local or proxied content. **MOD_CACHE** requires the services of one or more storage management modules. Two storage management modules are included in the base Apache distribution:

MOD_DISK_CACHE implements a disk based storage manager.

MOD_MEM_CACHE implements a memory based storage manager. **MOD_MEM_CACHE** can be configured to operate in two modes: caching open file descriptors or caching objects in heap storage. **MOD_MEM_CACHE** can be used to cache locally generated content or to cache backend server content for **MOD_PROXY** when configured using **PROXYPASS** (aka reverse proxy)

Content is stored in and retrieved from the cache using URI based keys. Content with access protection is not cached.

Directives

- CacheDefaultExpire
- CacheDisable
- CacheEnable
- CacheForceCompletion
- CacheIgnoreCacheControl
- CacheIgnoreHeaders
- CacheIgnoreNoLastMod
- CacheLastModifiedFactor
- CacheMaxExpire

⁷<http://www.ietf.org/rfc/rfc2616.txt>

Related Modules and Directives

Related Modules	Related Directives
MOD_DISK_CACHE	CACHEROOT
MOD_MEM_CACHE	CACHE_SIZE
	CACHEGCIINTERVAL
	CACHEDIRLEVELS
	CACHEDIRLENGTH
	CACHEEXPIRYCHECK
	CACHEMINFILESIZE
	CACHEMAXFILESIZE
	CACHETIMEMARGIN
	CACHEGCDAILY
	CACHEGCUNUSED
	CACHEGCCLEAN
	CACHEGCMEMUSAGE
	MCACHE_SIZE
	MCACHEMAXOBJECTCOUNT
	MCACHEMINOBJECTSIZE
	MCACHEMAXOBJECTSIZE
	MCACHEREMOVALALGORITHM
	MCACHEMAXSTREAMINGBUFFER

Sample Configuration

```

Sample httpd.conf
#
# Sample Cache Configuration
#
LoadModule cache_module modules/mod_cache.so
<IfModule mod_cache.c>
    #LoadModule disk_cache_module modules/mod_disk_cache.so
    <IfModule mod_disk_cache.c>
        CacheRoot c:/cacheroot
        CacheSize 256
        CacheEnable disk /
        CacheDirLevels 5
        CacheDirLength 3
    </IfModule>
    LoadModule mem_cache_module modules/mod_mem_cache.so
    <IfModule mod_mem_cache.c>
        CacheEnable mem /
        MCacheSize 4096
        MCacheMaxObjectCount 100
        MCacheMinObjectSize 1
        MCacheMaxObjectSize 2048
    </IfModule>
</IfModule>

```

CacheDefaultExpire Directive

Description:	The default duration to cache a document when no expiry date is specified.
Syntax:	CacheDefaultExpire seconds
Default:	CacheDefaultExpire 3600 (one hour)
Context:	server config, virtual host
Status:	Experimental
Module:	mod_cache

The [CACHEDEFAULTEXPIRE](#) directive specifies a default time, in seconds, to cache a document if neither an expiry date nor last-modified date are provided with the document. The value specified with the [CACHEMAXEXPIRE](#) directive does *not* override this setting.

```
CacheDefaultExpire 86400
```

CacheDisable Directive

Description:	Disable caching of specified URLs
Syntax:	CacheDisable url-string
Context:	server config, virtual host
Status:	Experimental
Module:	mod_cache

The [CACHEDISABLE](#) directive instructs [MOD_CACHE](#) to *not* cache urls at or below url-string.

Example

```
CacheDisable /local_files
```

CacheEnable Directive

Description:	Enable caching of specified URLs using a specified storage manager
Syntax:	CacheEnable cache_type url-string
Context:	server config, virtual host
Status:	Experimental
Module:	mod_cache

The [CACHEENABLE](#) directive instructs [MOD_CACHE](#) to cache urls at or below url-string. The cache storage manager is specified with the `cache_type` argument. `cache_type mem` instructs [MOD_CACHE](#) to use the memory based storage manager implemented by [MOD_MEM_CACHE](#). `cache_type disk` instructs [MOD_CACHE](#) to use the disk based storage manager implemented by [MOD_DISK_CACHE](#). `cache_type fd` instructs [MOD_CACHE](#) to use the file descriptor cache implemented by [MOD_MEM_CACHE](#).

In the event that the URL space overlaps between different [CACHEENABLE](#) directives (as in the example below), each possible storage manager will be run until the first one that actually processes the request. The order in which the storage managers are run is determined by the order of the [CACHEENABLE](#) directives in the configuration file.

```
CacheEnable mem /manual
CacheEnable fd /images
CacheEnable disk /
```

CacheForceCompletion Directive

Description:	Percentage of document served, after which the server will complete caching the file even if the request is cancelled.
Syntax:	CacheForceCompletion Percentage
Default:	CacheForceCompletion 60
Context:	server config, virtual host
Status:	Experimental
Module:	mod_cache

Ordinarily, if a request is cancelled while the response is being cached and delivered to the client the processing of the response will stop and the cache entry will be removed. The [CACHEFORCECOMPLETION](#) directive specifies a threshold beyond which the document will continue to be cached to completion, even if the request is cancelled.

The threshold is a percentage specified as a value between 1 and 100. A value of 0 specifies that the default be used. A value of 100 will only cache documents that are served in their entirety. A value between 60 and 90 is recommended.

```
CacheForceCompletion 80
```



Note:

This feature is currently *not* implemented.

CacheIgnoreCacheControl Directive

Description:	Ignore the fact that the client requested the content not be cached.
Syntax:	CacheIgnoreCacheControl On Off
Default:	CacheIgnoreCacheControl Off
Context:	server config, virtual host
Status:	Experimental
Module:	mod_cache

Ordinarily, documents with no-cache or no-store header values will not be stored in the cache. The [CACHEIGNORE-CACHECONTROL](#) directive allows this behavior to be overridden. [CACHEIGNORECACHECONTROL On](#) tells the server to attempt to cache the document even if it contains no-cache or no-store header values. Documents requiring authorization will *never* be cached.

```
CacheIgnoreCacheControl On
```

CacheIgnoreHeaders Directive

Description:	Do not store the given HTTP header(s) in the cache.
Syntax:	CacheIgnoreHeaders header-string [header-string] ...
Default:	CacheIgnoreHeaders None
Context:	server config, virtual host
Status:	Experimental
Module:	mod_cache

According to RFC 2616, hop-by-hop HTTP headers are not stored in the cache. The following HTTP headers are hop-by-hop headers and thus do not get stored in the cache in *any* case regardless of the setting of [CACHEIGNORE-HEADERS](#):

- Connection
- Keep-Alive
- Proxy-Authenticate
- Proxy-Authorization
- TE
- Trailers
- Transfer-Encoding
- Upgrade

CACHEIGNOREHEADERS specifies additional HTTP headers that should not be stored in the cache. For example, it makes sense in some cases to prevent cookies from being stored in the cache.

CACHEIGNOREHEADERS takes a space separated list of HTTP headers that should not be stored in the cache. If only hop-by-hop headers not should be stored in the cache (the RFC 2616 compliant behaviour), **CACHEIGNOREHEADERS** can be set to `None`.

Example 1

```
CacheIgnoreHeaders Set-Cookie
```

Example 2

```
CacheIgnoreHeaders None
```



Warning:

If headers like `Expires` which are needed for proper cache management are not stored due to a **CACHEIGNOREHEADERS** setting, the behaviour of `mod_cache` is undefined.

CacheIgnoreNoLastMod Directive

Description:	Ignore the fact that a response has no Last Modified header.
Syntax:	<code>CacheIgnoreNoLastMod On Off</code>
Default:	<code>CacheIgnoreNoLastMod Off</code>
Context:	server config, virtual host
Status:	Experimental
Module:	<code>mod_cache</code>

Ordinarily, documents without a last-modified date are not cached. Under some circumstances the last-modified date is removed (during **MOD_INCLUDE** processing for example) or not provided at all. The **CACHEIGNORENOLASTMOD** directive provides a way to specify that documents without last-modified dates should be considered for caching, even without a last-modified date. If neither a last-modified date nor an expiry date are provided with the document then the value specified by the **CACHEDEFAULTEXPIRE** directive will be used to generate an expiration date.

```
CacheIgnoreNoLastMod On
```

CacheLastModifiedFactor Directive

Description:	The factor used to compute an expiry date based on the LastModified date.
Syntax:	CacheLastModifiedFactor float
Default:	CacheLastModifiedFactor 0.1
Context:	server config, virtual host
Status:	Experimental
Module:	mod_cache

In the event that a document does not provide an expiry date but does provide a last-modified date, an expiry date can be calculated based on the time since the document was last modified. The `CACHELASTMODIFIEDFACTOR` directive specifies a factor to be used in the generation of this expiry date according to the following formula:

$$\text{expiry-period} = \text{time-since-last-modified-date} * \text{factor} \quad \text{expiry-date} = \text{current-date} + \text{expiry-period}$$

For example, if the document was last modified 10 hours ago, and factor is 0.1 then the expiry-period will be set to $10 * 0.1 = 1$ hour. If the current time was 3:00pm then the computed expiry-date would be 3:00pm + 1hour = 4:00pm.

If the expiry-period would be longer than that set by `CACHEMAXEXPIRE`, then the latter takes precedence.

```
CacheLastModifiedFactor 0.5
```

CacheMaxExpire Directive

Description:	The maximum time in seconds to cache a document
Syntax:	CacheMaxExpire seconds
Default:	CacheMaxExpire 86400 (one day)
Context:	server config, virtual host
Status:	Experimental
Module:	mod_cache

The `CACHEMAXEXPIRE` directive specifies the maximum number of seconds for which cachable HTTP documents will be retained without checking the origin server. Thus, documents will be out of date at most this number of seconds. This maximum value is enforced even if an expiry date was supplied with the document.

```
CacheMaxExpire 604800
```

10.15 Apache Module mod_cern_meta

Description:	CERN httpd metafile semantics
Status:	Extension
ModuleIdentifier:	cern_meta_module
SourceFile:	mod_cern_meta.c

Summary

Emulate the CERN HTTPD Meta file semantics. Meta files are HTTP headers that can be output in addition to the normal range of headers for each file accessed. They appear rather like the Apache .asis files, and are able to provide a crude way of influencing the Expires: header, as well as providing other curiosities. There are many ways to manage meta information, this one was chosen because there is already a large number of CERN users who can exploit this module.

More information on the CERN metafile semantics⁸ is available.

Directives

- MetaDir
- MetaFiles
- MetaSuffix

See also

- [MOD_HEADERS](#)
- [MOD_ASIS](#)

MetaDir Directive

Description:	Name of the directory to find CERN-style meta information files
Syntax:	MetaDir directory
Default:	MetaDir .web
Context:	server config, virtual host, directory, .htaccess
Override:	Indexes
Status:	Extension
Module:	mod_cern_meta

Specifies the name of the directory in which Apache can find meta information files. The directory is usually a 'hidden' subdirectory of the directory that contains the file being accessed. Set to "." to look in the same directory as the file:

```
MetaDir .
```

Or, to set it to a subdirectory of the directory containing the files:

```
MetaDir .meta
```

⁸<http://www.w3.org/pub/WWW/Daemon/User/Config/General.html#MetaDir>

MetaFiles Directive

Description:	Activates CERN meta-file processing
Syntax:	<code>MetaFiles on off</code>
Default:	<code>MetaFiles off</code>
Context:	server config, virtual host, directory, <code>.htaccess</code>
Override:	Indexes
Status:	Extension
Module:	<code>mod_cern_meta</code>

Turns on/off Meta file processing on a per-directory basis.

MetaSuffix Directive

Description:	File name suffix for the file containing CERN-style meta information
Syntax:	<code>MetaSuffix suffix</code>
Default:	<code>MetaSuffix .meta</code>
Context:	server config, virtual host, directory, <code>.htaccess</code>
Override:	Indexes
Status:	Extension
Module:	<code>mod_cern_meta</code>

Specifies the file name suffix for the file containing the meta information. For example, the default values for the two directives will cause a request to `DOCUMENT_ROOT/somedir/index.html` to look in `DOCUMENT_ROOT/somedir/.web/index.html.meta` and will use its contents to generate additional MIME header information.

Example:

```
MetaSuffix .meta
```

10.16 Apache Module mod_cgi

Description:	Execution of CGI scripts
Status:	Base
ModuleIdentifier:	cgi_module
SourceFile:	mod_cgi.c

Summary

Any file that has the mime type `application/x-httpd-cgi` or handler `cgi-script` (Apache 1.1 or later) will be treated as a CGI script, and run by the server, with its output being returned to the client. Files acquire this type either by having a name containing an extension defined by the `ADDTYPE` directive, or by being in a `SCRIPTALIAS` directory.

When the server invokes a CGI script, it will add a variable called `DOCUMENT_ROOT` to the environment. This variable will contain the value of the `DOCUMENTROOT` configuration variable.

For an introduction to using CGI scripts with Apache, see our tutorial on Dynamic Content With CGI (p. 185) .

When using a multi-threaded MPM under unix, the module `MOD_CGID` should be used in place of this module. At the user level, the two modules are essentially identical.

Directives

- `ScriptLog`
- `ScriptLogBuffer`
- `ScriptLogLength`

See also

- `ACCEPTPATHINFO`
- `OPTIONS`
- `SCRIPTALIAS`
- `ADDAHDLER`
- Running CGI programs under different user IDs (p. 68)
- CGI Specification⁹

CGI Environment variables

The server will set the CGI environment variables as described in the CGI specification¹⁰, with the following provisions:

PATH_INFO This will not be available if the `ACCEPTPATHINFO` directive is explicitly set to `off`. The default behavior, if `ACCEPTPATHINFO` is not given, is that `MOD_CGI` will accept path info (trailing `/more/path/info` following the script filename in the URI), while the core server will return a 404 NOT FOUND error for requests with additional path info. Omitting the `ACCEPTPATHINFO` directive has the same effect as setting it On for `MOD_CGI` requests.

⁹<http://hoohoo.ncsa.uiuc.edu/cgi/>

¹⁰<http://hoohoo.ncsa.uiuc.edu/cgi/>

REMOTE_HOST This will only be set if [HOSTNAMELOOKUPS](#) is set to `on` (it is off by default), and if a reverse DNS lookup of the accessing host's address indeed finds a host name.

REMOTE_IDENT This will only be set if [IDENTITYCHECK](#) is set to `on` and the accessing host supports the ident protocol. Note that the contents of this variable cannot be relied upon because it can easily be faked, and if there is a proxy between the client and the server, it is usually totally useless.

REMOTE_USER This will only be set if the CGI script is subject to authentication.

CGI Debugging

Debugging CGI scripts has traditionally been difficult, mainly because it has not been possible to study the output (standard output and error) for scripts which are failing to run properly. These directives, included in Apache 1.2 and later, provide more detailed logging of errors when they occur.

CGI Logfile Format

When configured, the CGI error log logs any CGI which does not execute properly. Each CGI script which fails to operate causes several lines of information to be logged. The first two lines are always of the format:

```
%% [time] request-line
%% HTTP-status CGI-script-filename
```

If the error is that CGI script cannot be run, the log file will contain an extra two lines:

```
%%error
error-message
```

Alternatively, if the error is the result of the script returning incorrect header information (often due to a bug in the script), the following information is logged:

```
%request
All HTTP request headers received
POST or PUT entity (if any)
%response
All headers output by the CGI script
%stdout
CGI standard output
%stderr
CGI standard error
```

(The `%stdout` and `%stderr` parts may be missing if the script did not output anything on standard output or standard error).

ScriptLog Directive

Description:	Location of the CGI script error logfile
Syntax:	<code>ScriptLog file-path</code>
Context:	server config, virtual host
Status:	Base
Module:	MOD_CGI , MOD_CGID

The **SCRIPTLOG** directive sets the CGI script error logfile. If no **SCRIPTLOG** is given, no error log is created. If given, any CGI errors are logged into the filename given as argument. If this is a relative file or path it is taken relative to the **SERVERROOT**.

Example

```
ScriptLog logs/cgi_log
```

This log will be opened as the user the child processes run as, *i.e.* the user specified in the main **USER** directive. This means that either the directory the script log is in needs to be writable by that user or the file needs to be manually created and set to be writable by that user. If you place the script log in your main logs directory, do **NOT** change the directory permissions to make it writable by the user the child processes run as.

Note that script logging is meant to be a debugging feature when writing CGI scripts, and is not meant to be activated continuously on running servers. It is not optimized for speed or efficiency, and may have security problems if used in a manner other than that for which it was designed.

ScriptLogBuffer Directive

Description:	Maximum amount of PUT or POST requests that will be recorded in the scriptlog
Syntax:	<code>ScriptLogBuffer bytes</code>
Default:	<code>ScriptLogBuffer 1024</code>
Context:	server config, virtual host
Status:	Base
Module:	MOD_CGI , MOD_CGID

The size of any PUT or POST entity body that is logged to the file is limited, to prevent the log file growing too big too quickly if large bodies are being received. By default, up to 1024 bytes are logged, but this can be changed with this directive.

ScriptLogLength Directive

Description:	Size limit of the CGI script logfile
Syntax:	<code>ScriptLogLength bytes</code>
Default:	<code>ScriptLogLength 10385760</code>
Context:	server config, virtual host
Status:	Base
Module:	MOD_CGI , MOD_CGID

SCRIPTLOGLength can be used to limit the size of the CGI script logfile. Since the logfile logs a lot of information per CGI error (all request headers, all script output) it can grow to be a big file. To prevent problems due to unbounded growth, this directive can be used to set an maximum file-size for the CGI logfile. If the file exceeds this size, no more information will be written to it.

10.17 Apache Module mod_cgid

Description:	Execution of CGI scripts using an external CGI daemon
Status:	Base
ModuleIdentifier:	cgid_module
SourceFile:	mod_cgid.c
Compatibility:	Unix threaded MPMs only

Summary

Except for the optimizations and the additional `SCRIPTSOCK` directive noted below, `MOD_CGID` behaves similarly to `MOD_CGI`. See the `MOD_CGI` summary for additional details about Apache and CGI.

On certain unix operating systems, forking a process from a multi-threaded server is a very expensive operation because the new process will replicate all the threads of the parent process. In order to avoid incurring this expense on each CGI invocation, `MOD_CGID` creates an external daemon that is responsible for forking child processes to run CGI scripts. The main server communicates with this daemon using a unix domain socket.

This module is used by default instead of `MOD_CGI` whenever a multi-threaded MPM is selected during the compilation process. At the user level, this module is identical in configuration and operation to `MOD_CGI`. The only exception is the additional directive `ScriptSock` which gives the name of the socket to use for communication with the cgi daemon.

Directives

- `ScriptLog` (p. 400)
- `ScriptLogBuffer` (p. 401)
- `ScriptLogLength` (p. 401)
- `ScriptSock`

See also

- `MOD_CGI`
- Running CGI programs under different user IDs (p. 68)

ScriptSock Directive

Description:	The name of the socket to use for communication with the cgi daemon
Syntax:	<code>ScriptSock file-path</code>
Default:	<code>ScriptSock logs/cgisock</code>
Context:	server config, virtual host
Status:	Base
Module:	mod_cgid

This directive sets the name of the socket to use for communication with the CGI daemon. The socket will be opened using the permissions of the user who starts Apache (usually root). To maintain the security of communications with CGI scripts, it is important that no other user has permission to write in the directory where the socket is located.

Example

```
ScriptSock /var/run/cgid.sock
```

10.18 Apache Module mod_charset_lite

Description:	Specify character set translation or recoding
Status:	Experimental
ModuleIdentifier:	charset_lite_module
SourceFile:	mod_charset_lite.c

Summary

This is an **experimental** module and should be used with care. Experiment with your `MOD_CHARSET_LITE` configuration to ensure that it performs the desired function.

`MOD_CHARSET_LITE` allows the administrator to specify the source character set of objects as well as the character set they should be translated into before sending to the client. `MOD_CHARSET_LITE` does not translate the data itself but instead tells Apache what translation to perform. `MOD_CHARSET_LITE` is applicable to EBCDIC and ASCII host environments. In an EBCDIC environment, Apache normally translates text content from the code page of the Apache process locale to ISO-8859-1. `MOD_CHARSET_LITE` can be used to specify that a different translation is to be performed. In an ASCII environment, Apache normally performs no translation, so `MOD_CHARSET_LITE` is needed in order for any translation to take place.

This module provides a small subset of configuration mechanisms implemented by Russian Apache and its associated `mod_charset`.

Directives

- CharsetDefault
- CharsetOptions
- CharsetSourceEnc

Common Problems

Invalid character set names

The character set name parameters of `CHARSETSOURCEENC` and `CHARSETDEFAULT` must be acceptable to the translation mechanism used by APR on the system where `MOD_CHARSET_LITE` is deployed. These character set names are not standardized and are usually not the same as the corresponding values used in http headers. Currently, APR can only use `iconv(3)`, so you can easily test your character set names using the `iconv(1)` program, as follows:

```
iconv -f charsetsourceenc-value -t charsetdefault-value
```

Mismatch between character set of content and translation rules

If the translation rules don't make sense for the content, translation can fail in various ways, including:

- The translation mechanism may return a bad return code, and the connection will be aborted.
- The translation mechanism may silently place special characters (e.g., question marks) in the output buffer when it cannot translate the input buffer.

CharsetDefault Directive

Description:	Charset to translate into
Syntax:	CharsetDefault charset
Context:	server config, virtual host, directory, .htaccess
Override:	FileInfo
Status:	Experimental
Module:	mod_charset_lite

The [CHARSETDEFAULT](#) directive specifies the charset that content in the associated container should be translated to. The value of the charset argument must be accepted as a valid character set name by the character set support in APR. Generally, this means that it must be supported by iconv.

Example

```
<Directory /export/home/trawick/apacheinst/htdocs/convert>
  CharsetSourceEnc UTF-16BE
  CharsetDefault ISO-8859-1
</Directory>
```

CharsetOptions Directive

Description:	Configures charset translation behavior
Syntax:	CharsetOptions option [option] ...
Default:	CharsetOptions DebugLevel=0 NoImplicitAdd
Context:	server config, virtual host, directory, .htaccess
Override:	FileInfo
Status:	Experimental
Module:	mod_charset_lite

The [CHARSETOPTIONS](#) directive configures certain behaviors of [MOD_CHARSET_LITE](#). Option can be one of

DebugLevel=*n* The `DebugLevel` keyword allows you to specify the level of debug messages generated by [MOD_CHARSET_LITE](#). By default, no messages are generated. This is equivalent to `DebugLevel=0`. With higher numbers, more debug messages are generated, and server performance will be degraded. The actual meanings of the numeric values are described with the definitions of the `DBGLVL_` constants near the beginning of `mod_charset_lite.c`.

ImplicitAdd | NoImplicitAdd The `ImplicitAdd` keyword specifies that [MOD_CHARSET_LITE](#) should implicitly insert its filter when the configuration specifies that the character set of content should be translated. If the filter chain is explicitly configured using the [ADDOUTPUTFILTER](#) directive, `NoImplicitAdd` should be specified so that [MOD_CHARSET_LITE](#) doesn't add its filter.

CharsetSourceEnc Directive

Description:	Source charset of files
Syntax:	CharsetSourceEnc charset
Context:	server config, virtual host, directory, .htaccess
Override:	FileInfo
Status:	Experimental
Module:	mod_charset_lite

The [CHARSETSOURCEENC](#) directive specifies the source charset of files in the associated container.

The value of the charset argument must be accepted as a valid character set name by the character set support in APR. Generally, this means that it must be supported by iconv.

Example

```
<Directory /export/home/trawick/apacheinst/htdocs/convert>  
    CharsetSourceEnc UTF-16BE  
    CharsetDefault ISO-8859-1  
</Directory>
```

The character set names in this example work with the iconv translation support in Solaris 8.

10.19 Apache Module `mod_dav`

Description:	Distributed Authoring and Versioning (WebDAV ¹¹) functionality
Status:	Extension
ModuleIdentifier:	<code>dav_module</code>
SourceFile:	<code>mod_dav.c</code>

Summary

This module provides class 1 and class 2 WebDAV¹² ('Web-based Distributed Authoring and Versioning') functionality for Apache. This extension to the HTTP protocol allows creating, moving, copying, and deleting resources and collections on a remote web server.

Directives

- `Dav`
- `DavDepthInfinity`
- `DavMinTimeout`

See also

- [DAVLOCKDB](#)
- [LIMITXMLREQUESTBODY](#)
- [WebDAV Resources](#)¹³

Enabling WebDAV

To enable `MOD_DAV`, add the following to a container in your `httpd.conf` file:

```
Dav On
```

This enables the DAV file system provider, which is implemented by the `MOD_DAV_FS` module. Therefore, that module must be compiled into the server or loaded at runtime using the `LOADMODULE` directive.

In addition, a location for the DAV lock database must be specified in the global section of your `httpd.conf` file using the `DAVLOCKDB` directive:

```
DavLockDB /usr/local/apache2/var/DavLock
```

The directory containing the lock database file must be writable by the `USER` and `GROUP` under which Apache is running.

You may wish to add a `<LIMIT>` clause inside the `<LOCATION>` directive to limit access to DAV-enabled locations. If you want to set the maximum amount of bytes that a DAV client can send at one request, you have to use the `LIMITXMLREQUESTBODY` directive. The "normal" `LIMITREQUESTBODY` directive has no effect on DAV requests.

¹²<http://www.webdav.org>

¹³<http://www.webdav.org>

Full Example

```
DavLockDB /usr/local/apache2/var/DavLock
<Location /foo>
  Dav On
  AuthType Basic
  AuthName DAV
  AuthUserFile user.passwd
  <LimitExcept GET OPTIONS>
    require user admin
  </LimitExcept>
</Location>
```

[MOD_DAV](#) is a descendent of Greg Stein's `mod_dav` for Apache 1.3¹⁴. More information about the module is available from that site.

Security Issues

Since DAV access methods allow remote clients to manipulate files on the server, you must take particular care to assure that your server is secure before enabling [MOD_DAV](#).

Any location on the server where DAV is enabled should be protected by authentication. The use of HTTP Basic Authentication is not recommended. You should use at least HTTP Digest Authentication, which is provided by the [MOD_AUTH_DIGEST](#) module. Nearly all WebDAV clients support this authentication method. An alternative is Basic Authentication over an SSL (p. 146) enabled connection.

In order for [MOD_DAV](#) to manage files, it must be able to write to the directories and files under its control using the [USER](#) and [GROUP](#) under which Apache is running. New files created will also be owned by this [USER](#) and [GROUP](#). For this reason, it is important to control access to this account. The DAV repository is considered private to Apache; modifying files outside of Apache (for example using FTP or filesystem-level tools) should not be allowed.

[MOD_DAV](#) may be subject to various kinds of denial-of-service attacks. The [LIMITXMLREQUESTBODY](#) directive can be used to limit the amount of memory consumed in parsing large DAV requests. The [DAVDEPTHINFINITY](#) directive can be used to prevent `PROPFIND` requests on a very large repository from consuming large amounts of memory. Another possible denial-of-service attack involves a client simply filling up all available disk space with many large files. There is no direct way to prevent this in Apache, so you should avoid giving DAV access to untrusted users.

Complex Configurations

One common request is to use [MOD_DAV](#) to manipulate dynamic files (PHP scripts, CGI scripts, etc). This is difficult because a `GET` request will always run the script, rather than downloading its contents. One way to avoid this is to map two different URLs to the content, one of which will run the script, and one of which will allow it to be downloaded and manipulated with DAV.

```
Alias /phparea /home/gstein/php_files
Alias /php-source /home/gstein/php_files
<Location /php-source>
  DAV On
  ForceType text/plain
</Location>
```

¹⁴http://www.webdav.org/mod_dav/

With this setup, `http://example.com/phparea` can be used to access the output of the PHP scripts, and `http://example.com/php-source` can be used with a DAV client to manipulate them.

Dav Directive

Description:	Enable WebDAV HTTP methods
Syntax:	<code>Dav On Off provider-name</code>
Default:	<code>Dav Off</code>
Context:	directory
Status:	Extension
Module:	<code>mod_dav</code>

Use the [DAV](#) directive to enable the WebDAV HTTP methods for the given container:

```
<Location /foo>
  Dav On
</Location>
```

The value `On` is actually an alias for the default provider `filesystem` which is served by the [MOD_DAV_FS](#) module. Note, that once you have DAV enabled for some location, it *cannot* be disabled for sublocations. For a complete configuration example have a look at the section above.



Do not enable WebDAV until you have secured your server. Otherwise everyone will be able to distribute files on your system.

DavDepthInfinity Directive

Description:	Allow PROPFIND, Depth: Infinity requests
Syntax:	<code>DavDepthInfinity on off</code>
Default:	<code>DavDepthInfinity off</code>
Context:	server config, virtual host, directory
Status:	Extension
Module:	<code>mod_dav</code>

Use the [DAVDEPTHINFINITY](#) directive to allow the processing of PROPFIND requests containing the header 'Depth: Infinity'. Because this type of request could constitute a denial-of-service attack, by default it is not allowed.

DavMinTimeout Directive

Description:	Minimum amount of time the server holds a lock on a DAV resource
Syntax:	<code>DavMinTimeout seconds</code>
Default:	<code>DavMinTimeout 0</code>
Context:	server config, virtual host, directory
Status:	Extension
Module:	<code>mod_dav</code>

When a client requests a DAV resource lock, it can also specify a time when the lock will be automatically removed by the server. This value is only a request, and the server can ignore it or inform the client of an arbitrary value.

Use the [DAVMINTIMEOUT](#) directive to specify, in seconds, the minimum lock timeout to return to a client. Microsoft Web Folders defaults to a timeout of 120 seconds; the [DAVMINTIMEOUT](#) can override this to a higher value (like 600 seconds) to reduce the chance of the client losing the lock due to network latency.

Example

```
<Location /MSWord>  
    DavMinTimeout 600  
</Location>
```

10.20 Apache Module `mod_dav_fs`

Description:	filesystem provider for MOD_DAV
Status:	Extension
ModuleIdentifier:	<code>dav_fs_module</code>
SourceFile:	<code>mod_dav_fs.c</code>

Summary

This module *requires* the service of [MOD_DAV](#). It acts as a support module for [MOD_DAV](#) and provides access to resources located in the server's file system. The formal name of this provider is `filesystem`. [MOD_DAV](#) backend providers will be invoked by using the [DAV](#) directive:

Example

```
Dav filesystem
```

Since `filesystem` is the default provider for [MOD_DAV](#), you may simply use the value `On` instead.

Directives

- [DavLockDB](#)

See also

- [MOD_DAV](#)

DavLockDB Directive

Description:	Location of the DAV lock database
Syntax:	<code>DavLockDB file-path</code>
Context:	server config, virtual host
Status:	Extension
Module:	<code>mod_dav_fs</code>

Use the [DAVLOCKDB](#) directive to specify the full path to the lock database, excluding an extension. If the path is not absolute, it will be taken relative to [SERVERROOT](#). The implementation of [MOD_DAV_FS](#) uses a SDBM database to track user locks.

Example

```
DavLockDB var/DavLock
```

The directory containing the lock database file must be writable by the [USER](#) and [GROUP](#) under which Apache is running. For security reasons, you should create a directory for this purpose rather than changing the permissions on an existing directory. In the above example, Apache will create files in the `var/` directory under the [SERVERROOT](#) with the base filename `DavLock` and extension name chosen by the server.

10.21 Apache Module mod_deflate

Description:	Compress content before it is delivered to the client
Status:	Extension
ModuleIdentifier:	deflate_module
SourceFile:	mod_deflate.c

Summary

The `MOD_DEFLATE` module provides the `DEFLATE` output filter that allows output from your server to be compressed before being sent to the client over the network.

Directives

- `DeflateBufferSize`
- `DeflateCompressionLevel`
- `DeflateFilterNote`
- `DeflateMemLevel`
- `DeflateWindowSize`

See also

- [Filters \(p. 67\)](#)

Sample Configurations

This is a simple sample configuration for the impatient.

Compress only a few types

```
AddOutputFilterByType DEFLATE text/html text/plain text/xml
```

The following configuration, while resulting in more compressed content, is also much more complicated. Do not use this unless you fully understand all the configuration details.

Compress everything except images

```

<Location />
  # Insert filter
  SetOutputFilter DEFLATE

  # Netscape 4.x has some problems...
  BrowserMatch ^Mozilla/4 gzip-only-text/html

  # Netscape 4.06-4.08 have some more problems
  BrowserMatch ^Mozilla/4\.0[678] no-gzip

  # MSIE masquerades as Netscape, but it is fine
  # BrowserMatch \bMSIE !no-gzip !gzip-only-text/html

  # NOTE: Due to a bug in mod_setenvif up to Apache 2.0.48
  # the above regex won't work. You can use the following
  # workaround to get the desired effect:
  BrowserMatch \bMSI[E] !no-gzip !gzip-only-text/html

  # Don't compress images
  SetEnvIfNoCase Request_URI \
    \.(?:gif|jpe?g|png)$ no-gzip dont-vary

  # Make sure proxies don't deliver the wrong content
  Header append Vary User-Agent env=!dont-vary
</Location>

```

Enabling Compression

Output Compression

Compression is implemented by the DEFLATE filter (p. 67) . The following directive will enable compression for documents in the container where it is placed:

```
SetOutputFilter DEFLATE
```

Some popular browsers cannot handle compression of all content so you may want to set the `gzip-only-text/html` note to 1 to only allow html files to be compressed (see below). If you set this to *anything but 1* it will be ignored.

If you want to restrict the compression to particular MIME types in general, you may use the [ADDOUTPUTFILTER-BYTYPE](#) directive. Here is an example of enabling compression only for the html files of the Apache documentation:

```

<Directory "/your-server-root/manual">
  AddOutputFilterByType DEFLATE text/html
</Directory>

```

For browsers that have problems even with compression of all file types, use the [BROWSERMATCH](#) directive to set the `no-gzip` note for that particular browser so that no compression will be performed. You may combine `no-gzip` with `gzip-only-text/html` to get the best results. In that case the former overrides the latter. Take a look at the following excerpt from the configuration example defined in the section above:

```

BrowserMatch ^Mozilla/4 gzip-only-text/html
BrowserMatch ^Mozilla/4\.0[678] no-gzip
BrowserMatch \bMSIE !no-gzip !gzip-only-text/html

```

At first we probe for a `User-Agent` string that indicates a Netscape Navigator version of 4.x. These versions cannot handle compression of types other than `text/html`. The versions 4.06, 4.07 and 4.08 also have problems with decompressing html files. Thus, we completely turn off the deflate filter for them.

The third `BROWSERMATCH` directive fixes the guessed identity of the user agent, because the Microsoft Internet Explorer identifies itself also as "Mozilla/4" but is actually able to handle requested compression. Therefore we match against the additional string "MSIE" (`\b` means "word boundary") in the `User-Agent` Header and turn off the restrictions defined before.

⇒ Note

The `DEFLATE` filter is always inserted after `RESOURCE` filters like PHP or SSI. It never touches internal subrequests.

Input Decompression

The `MOD_DEFLATE` module also provides a filter for decompressing a gzip compressed request body . In order to activate this feature you have to insert the `DEFLATE` filter into the input filter chain using `SETINPUTFILTER` or `ADDINPUTFILTER`, for example:

```
<Location /dav-area>
  SetInputFilter DEFLATE
</Location>
```

Now if a request contains a `Content-Encoding: gzip` header, the body will be automatically decompressed. Few browsers have the ability to gzip request bodies. However, some special applications actually do support request compression, for instance some WebDAV¹⁵ clients.



Note on Content-Length

If you evaluate the request body yourself, *don't trust the Content-Length header!* The `Content-Length` header reflects the length of the incoming data from the client and *not* the byte count of the decompressed data stream.

Dealing with proxy servers

The `MOD_DEFLATE` module sends a `Vary: Accept-Encoding` HTTP response header to alert proxies that a cached response should be sent only to clients that send the appropriate `Accept-Encoding` request header. This prevents compressed content from being sent to a client that will not understand it.

If you use some special exclusions dependent on, for example, the `User-Agent` header, you must manually configure an addition to the `Vary` header to alert proxies of the additional restrictions. For example, in a typical configuration where the addition of the `DEFLATE` filter depends on the `User-Agent`, you should add:

```
Header append Vary User-Agent
```

If your decision about compression depends on other information than request headers (*e.g.* HTTP version), you have to set the `Vary` header to the value `*`. This prevents compliant proxies from caching entirely.

Example

```
Header set Vary *
```

¹⁵<http://www.webdav.org>

DeflateBufferSize Directive

Description:	Fragment size to be compressed at one time by zlib
Syntax:	DeflateBufferSize value
Default:	DeflateBufferSize 8096
Context:	server config, virtual host
Status:	Extension
Module:	mod_deflate

The [DEFLATEBUFFERSIZE](#) directive specifies the size in bytes of the fragments that zlib should compress at one time.

DeflateCompressionLevel Directive

Description:	How much compression do we apply to the output
Syntax:	DeflateCompressionLevel value
Default:	Zlib's default
Context:	server config, virtual host
Status:	Extension
Module:	mod_deflate
Compatibility:	This directive is available since Apache 2.0.45

The [DEFLATECOMPRESSIONLEVEL](#) directive specifies what level of compression should be used, the higher the value, the better the compression, but the more CPU time is required to achieve this.

The value must be between 1 (less compression) and 9 (more compression).

DeflateFilterNote Directive

Description:	Places the compression ratio in a note for logging
Syntax:	DeflateFilterNote [type] notename
Context:	server config, virtual host
Status:	Extension
Module:	mod_deflate
Compatibility:	type is available since Apache 2.0.45

The [DEFLATEFILTERNOTE](#) directive specifies that a note about compression ratios should be attached to the request. The name of the note is the value specified for the directive. You can use that note for statistical purposes by adding the value to your access log (p. 29).

Example

```
DeflateFilterNote ratio
LogFormat "%r" %b (%{ratio}n) "%{User-agent}i" deflate
CustomLog logs/deflate.log deflate
```

If you want to extract more accurate values from your logs, you can use the type argument to specify the type of data left as note for logging. type can be one of:

Input Store the byte count of the filter's input stream in the note.

Output Store the byte count of the filter's output stream in the note.

Ratio Store the compression ratio (output/input * 100) in the note. This is the default, if the type argument is omitted.

Thus you may log it this way:

Accurate Logging

```
DeflateFilterNote Input instream
DeflateFilterNote Output outstream
DeflateFilterNote Ratio ratio
LogFormat '%r" %s\n/%s\n (%r)n%' deflate
CustomLog logs/deflate_log deflate
```

See also

- [MOD_LOG_CONFIG](#)

DeflateMemLevel Directive

Description:	How much memory should be used by zlib for compression
Syntax:	DeflateMemLevel value
Default:	DeflateMemLevel 9
Context:	server config, virtual host
Status:	Extension
Module:	mod_deflate

The [DEFLATEMEMLEVEL](#) directive specifies how much memory should be used by zlib for compression (a value between 1 and 9).

DeflateWindowSize Directive

Description:	Zlib compression window size
Syntax:	DeflateWindowSize value
Default:	DeflateWindowSize 15
Context:	server config, virtual host
Status:	Extension
Module:	mod_deflate

The [DEFLATEWINDOWSIZE](#) directive specifies the zlib compression window size (a value between 1 and 15). Generally, the higher the window size, the higher can the compression ratio be expected.

10.22 Apache Module `mod_dir`

Description:	Provides for "trailing slash" redirects and serving directory index files
Status:	Base
ModuleIdentifier:	<code>dir_module</code>
SourceFile:	<code>mod_dir.c</code>

Summary

The index of a directory can come from one of two sources:

- A file written by the user, typically called `index.html`. The `DIRECTORYINDEX` directive sets the name of this file. This is controlled by `MOD_DIR`.
- Otherwise, a listing generated by the server. This is provided by `MOD_AUTOINDEX`.

The two functions are separated so that you can completely remove (or replace) automatic index generation should you want to.

A "trailing slash" redirect is issued when the server receives a request for a URL `http://servername/foo/dirname` where `dirname` is a directory. Directories require a trailing slash, so `MOD_DIR` issues a redirect to `http://servername/foo/dirname/`.

Directives

- `DirectoryIndex`
- `DirectorySlash`

DirectoryIndex Directive

Description:	List of resources to look for when the client requests a directory
Syntax:	<code>DirectoryIndex local-url [local-url] ...</code>
Default:	<code>DirectoryIndex index.html</code>
Context:	server config, virtual host, directory, <code>.htaccess</code>
Override:	Indexes
Status:	Base
Module:	<code>mod_dir</code>

The `DIRECTORYINDEX` directive sets the list of resources to look for, when the client requests an index of the directory by specifying a `/` at the end of the directory name. `Local-url` is the (%-encoded) URL of a document on the server relative to the requested directory; it is usually the name of a file in the directory. Several URLs may be given, in which case the server will return the first one that it finds. If none of the resources exist and the `Indexes` option is set, the server will generate its own listing of the directory.

Example

```
DirectoryIndex index.html
```

then a request for `http://myserver/docs/` would return `http://myserver/docs/index.html` if it exists, or would list the directory if it did not.

Note that the documents do not need to be relative to the directory;

```
DirectoryIndex index.html index.txt /cgi-bin/index.pl
```

would cause the CGI script `/cgi-bin/index.pl` to be executed if neither `index.html` or `index.txt` existed in a directory.

DirectorySlash Directive

Description:	Toggle trailing slash redirects on or off
Syntax:	DirectorySlash On Off
Default:	DirectorySlash On
Context:	server config, virtual host, directory, .htaccess
Override:	Indexes
Status:	Base
Module:	mod_dir
Compatibility:	Available in version 2.0.51 and later

The **DIRECTORYSLASH** directive determines, whether **MOD_DIR** should fixup URLs pointing to a directory or not.

Typically if a user requests a resource without a trailing slash, which points to a directory, **MOD_DIR** redirects him to the same resource, but *with* trailing slash for some good reasons:

- The user is finally requesting the canonical URL of the resource
- **MOD_AUTOINDEX** works correctly. Since it doesn't emit the path in the link, it would point to the wrong path.
- **DIRECTORYINDEX** will be evaluated *only* for directories requested with trailing slash.
- Relative URL references inside html pages will work correctly.

Well, if you don't want this effect *and* the reasons above don't apply to you, you can turn off the redirect with:

```
# see security warning below!
<Location /some/path>
    DirectorySlash Off
    SetHandler some-handler
</Location>
```



Security Warning

Turning off the trailing slash redirect may result in an information disclosure. Consider a situation where **MOD_AUTOINDEX** is active (`Options +Indexes`) and **DIRECTORYINDEX** is set to a valid resource (say, `index.html`) and there's no other special handler defined for that URL. In this case a request with a trailing slash would show the `index.html` file. **But a request without trailing slash would list the directory contents.**

10.23 Apache Module `mod_disk_cache`

Description:	Content cache storage manager keyed to URIs
Status:	Experimental
ModuleIdentifier:	<code>disk_cache_module</code>
SourceFile:	<code>mod_disk_cache.c</code>

Summary



This module is experimental. Documentation is still under development...

`MOD_DISK_CACHE` implements a disk based storage manager. It is primarily of use in conjunction with `MOD_PROXY`. Content is stored in and retrieved from the cache using URI based keys. Content with access protection is not cached.

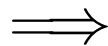

Note:

`MOD_DISK_CACHE` requires the services of `MOD_CACHE`.

Directives

- `CacheDirLength`
- `CacheDirLevels`
- `CacheExpiryCheck`
- `CacheGcClean`
- `CacheGcDaily`
- `CacheGcInterval`
- `CacheGcMemUsage`
- `CacheGcUnused`
- `CacheMaxFileSize`
- `CacheMinFileSize`
- `CacheRoot`
- `CacheSize`
- `CacheTimeMargin`

`CacheDirLength` Directive

Description:	The number of characters in subdirectory names
Syntax:	<code>CacheDirLength length</code>
Default:	<code>CacheDirLength 2</code>
Context:	server config, virtual host
Status:	Experimental
Module:	<code>mod_disk_cache</code>

The `CACHEDIRLENGTH` directive sets the number of characters for each subdirectory name in the cache hierarchy.

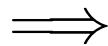

The result of `CACHEDIRLEVELS * CACHEDIRLENGTH` must not be higher than 20.

```
CacheDirLength 4
```

CacheDirLevels Directive

Description:	The number of levels of subdirectories in the cache.
Syntax:	CacheDirLevels levels
Default:	CacheDirLevels 3
Context:	server config, virtual host
Status:	Experimental
Module:	mod_disk_cache

The [CACHEDIRLEVELS](#) directive sets the number of subdirectory levels in the cache. Cached data will be saved this many directory levels below the [CACHEROOT](#) directory.

⇒ The result of [CACHEDIRLEVELS](#)* [CACHEDIRLENGTH](#) must not be higher than 20.

```
CacheDirLevels 5
```

CacheExpiryCheck Directive

Description:	Indicates if the cache observes Expires dates when seeking files
Syntax:	CacheExpiryCheck On Off
Default:	CacheExpiryCheck On
Context:	server config, virtual host
Status:	Experimental
Module:	mod_disk_cache

More detail will be added here, when the function is implemented.

```
CacheExpiryCheck Off
```



The [CACHEEXPIRYCHECK](#) directive is currently *not* implemented.

CacheGcClean Directive

Description:	The time to retain unchanged cached files that match a URL
Syntax:	CacheGcClean hours url-string
Default:	CacheGcClean ?
Context:	server config, virtual host
Status:	Experimental
Module:	mod_disk_cache

More detail will be added here, when the function is implemented.

```
CacheGcClean 12 /daily_scripts
```



The [CACHEGCCLEAN](#) directive is currently *not* implemented.

CacheGcDaily Directive

Description:	The recurring time each day for garbage collection to be run. (24 hour clock)
Syntax:	CacheGcDaily time
Default:	CacheGcDaily ?
Context:	server config, virtual host
Status:	Experimental
Module:	mod_disk_cache

More detail will be added here, when the function is implemented.

```
CacheGcDaily 23:59
```



The **CACHEGCDAILY** directive is currently *not* implemented.

CacheGcInterval Directive

Description:	The interval between garbage collection attempts.
Syntax:	CacheGcInterval hours
Context:	server config, virtual host
Status:	Experimental
Module:	mod_disk_cache

The **CACHEGCINTERVAL** directive specifies the number of hours to wait between attempts to free up disk space.

More detail will be added here, when the function is implemented.

```
CacheGcInterval 24
```



The **CACHEGCINTERVAL** directive is currently *not* implemented.

CacheGcMemUsage Directive

Description:	The maximum kilobytes of memory used for garbage collection
Syntax:	CacheGcMemUsage KBytes
Default:	CacheGcMemUsage ?
Context:	server config, virtual host
Status:	Experimental
Module:	mod_disk_cache

More detail will be added here, when the function is implemented.

```
CacheGcMemUsage 16
```



The **CACHEGCMEMUSAGE** directive is currently *not* implemented.

CacheGcUnused Directive

Description:	The time to retain unreferenced cached files that match a URL.
Syntax:	CacheGcUnused hours url-string
Default:	CacheGcUnused ?
Context:	server config, virtual host
Status:	Experimental
Module:	mod_disk_cache

More detail will be added here, when the function is implemented.

```
CacheGcUnused 12 /local_images
```



The **CACHEGCUNUSED** directive is currently *not* implemented.

CacheMaxFileSize Directive

Description:	The maximum size (in bytes) of a document to be placed in the cache
Syntax:	CacheMaxFileSize bytes
Default:	CacheMaxFileSize 1000000
Context:	server config, virtual host
Status:	Experimental
Module:	mod_disk_cache

The **CACHEMAXFILESIZE** directive sets the maximum size, in bytes, for a document to be considered for storage in the cache.

```
CacheMaxFileSize 64000
```

CacheMinFileSize Directive

Description:	The minimum size (in bytes) of a document to be placed in the cache
Syntax:	CacheMinFileSize bytes
Default:	CacheMinFileSize 1
Context:	server config, virtual host
Status:	Experimental
Module:	mod_disk_cache

The **CACHEMINFILESIZE** directive sets the minimum size, in bytes, for a document to be considered for storage in the cache.

```
CacheMinFileSize 64
```

CacheRoot Directive

Description:	The directory root under which cache files are stored
Syntax:	CacheRoot directory
Context:	server config, virtual host
Status:	Experimental
Module:	mod_disk_cache

The `CACHEROOT` directive defines the name of the directory on the disk to contain cache files. If the `MOD_DISK_CACHE` module has been loaded or compiled in to the Apache server, this directive *must* be defined. Failing to provide a value for `CACHEROOT` will result in a configuration file processing error. The `CACHEDIRLEVELS` and `CACHEDIRLENGTH` directives define the structure of the directories under the specified root directory.

```
CacheRoot c:/cacheroot
```

CacheSize Directive

Description:	The maximum amount of disk space that will be used by the cache in KBytes
Syntax:	CacheSize KBytes
Default:	CacheSize 1000000
Context:	server config, virtual host
Status:	Experimental
Module:	mod_disk_cache

The `CACHESIZE` directive sets the desired disk space usage of the cache, in KBytes (1024-byte units). This directive does not put a hard limit on the size of the cache. The garbage collector will delete files until the usage is at or below the settings. Always use a value that is lower than the available disk space.

```
CacheSize 5000000
```

CacheTimeMargin Directive

Description:	The minimum time margin to cache a document
Syntax:	CacheTimeMargin ?
Default:	CacheTimeMargin ?
Context:	server config, virtual host
Status:	Experimental
Module:	mod_disk_cache

More detail will be added here, when the function is implemented.

```
CacheTimeMargin X
```



The `CACHETIMEMARGIN` directive is currently *not* implemented.

10.24 Apache Module mod_dumpio

Description:	Dumps all I/O to error log as desired.
Status:	Experimental
ModuleIdentifier:	dumpio_module
SourceFile:	mod_dumpio.c

Summary

mod_dumpio allows for the logging of all input received by Apache and/or all output sent by Apache to be logged (dumped) to the error.log file.

The data logging is done right after SSL decoding (for input) and right before SSL encoding (for output). As can be expected, this can produce extreme volumes of data, and should only be used when debugging problems.

Directives

- DumpIOInput
- DumpIOOutput

Enabling dumpio Support

To enable the module, it should be compiled and loaded in to your running Apache configuration. Logging can then be enabled or disabled via the below directives.

In order for dumping to work `LOGLEVEL` must be set to debug.

DumpIOInput Directive

Description:	Dump all input data to the error log
Syntax:	DumpIOInput On Off
Default:	DumpIOInput Off
Context:	server config
Status:	Experimental
Module:	mod_dumpio
Compatibility:	DumpIOInput is only available in Apache 2.0.53 and later.

Enable dumping of all input.

Example

```
DumpIOInput On
```

DumpIOOutput Directive

Description:	Dump all output data to the error log
Syntax:	DumpIOOutput On Off
Default:	DumpIOOutput Off
Context:	server config
Status:	Experimental
Module:	mod_dumpio
Compatibility:	DumpIOOutput is only available in Apache 2.0.53 and later.

Enable dumping of all output.

Example

```
DumpIOOutput On
```

10.25 Apache Module mod_echo

Description:	A simple echo server to illustrate protocol modules
Status:	Experimental
ModuleIdentifier:	echo_module
SourceFile:	mod_echo.c
Compatibility:	Available in Apache 2.0 and later

Summary

This module provides an example protocol module to illustrate the concept. It provides a simple echo server. Telnet to it and type stuff, and it will echo it.

Directives

- ProtocolEcho

ProtocolEcho Directive

Description:	Turn the echo server on or off
Syntax:	ProtocolEcho On Off
Context:	server config, virtual host
Status:	Experimental
Module:	mod_echo
Compatibility:	ProtocolEcho is only available in 2.0 and later.

The [PROTCOLECHO](#) directive enables or disables the echo server.

Example

```
ProtocolEcho On
```

10.26 Apache Module `mod_env`

Description:	Modifies the environment which is passed to CGI scripts and SSI pages
Status:	Base
ModuleIdentifier:	<code>env_module</code>
SourceFile:	<code>mod_env.c</code>

Summary

This module allows for control of the environment that will be provided to CGI scripts and SSI pages. Environment variables may be passed from the shell which invoked the `httpd` process. Alternatively, environment variables may be set or unset within the configuration process.

Directives

- `PassEnv`
- `SetEnv`
- `UnsetEnv`

See also

- Environment Variables (p. 60)

PassEnv Directive

Description:	Passes environment variables from the shell
Syntax:	<code>PassEnv env-variable [env-variable] ...</code>
Context:	server config, virtual host, directory, <code>.htaccess</code>
Override:	<code>FileInfo</code>
Status:	Base
Module:	<code>mod_env</code>

Specifies one or more environment variables to pass to CGI scripts and SSI pages from the environment of the shell which invoked the `httpd` process.

Example

```
PassEnv LD_LIBRARY_PATH
```

SetEnv Directive

Description:	Sets environment variables
Syntax:	<code>SetEnv env-variable value</code>
Context:	server config, virtual host, directory, <code>.htaccess</code>
Override:	<code>FileInfo</code>
Status:	Base
Module:	<code>mod_env</code>

Sets an environment variable, which is then passed on to CGI scripts and SSI pages.

Example

```
SetEnv SPECIAL_PATH /foo/bin
```

UnsetEnv Directive

Description:	Removes variables from the environment
Syntax:	UnsetEnv env-variable [env-variable] ...
Context:	server config, virtual host, directory, .htaccess
Override:	FileInfo
Status:	Base
Module:	mod_env

Removes one or more environment variables from those passed on to CGI scripts and SSI pages.

Example

```
UnsetEnv LD_LIBRARY_PATH
```

10.27 Apache Module `mod_example`

Description:	Illustrates the Apache module API
Status:	Experimental
ModuleIdentifier:	<code>example_module</code>
SourceFile:	<code>mod_example.c</code>

Summary



This document has not been updated to take into account changes made in the 2.0 version of the Apache HTTP Server. Some of the information may still be relevant, but please use it with care.

The files in the `src/modules/example` directory under the Apache distribution directory tree are provided as an example to those that wish to write modules that use the Apache API.

The main file is `mod_example.c`, which illustrates all the different callback mechanisms and call syntaxes. By no means does an add-on module need to include routines for all of the callbacks - quite the contrary!

The example module is an actual working module. If you link it into your server, enable the "example-handler" handler for a location, and then browse to that location, you will see a display of some of the tracing the example module did as the various callbacks were made.

Directives

- Example

Compiling the example module

To include the example module in your server, follow the steps below:

1. Uncomment the "AddModule `modules/example/mod_example`" line near the bottom of the `src/Configuration` file. If there isn't one, add it; it should look like this:

```
AddModule modules/example/mod_example.o
```

2. Run the `src/Configure` script ("`cdsrc; ./Configure`"). This will build the Makefile for the server itself, and update the `src/modules/Makefile` for any additional modules you have requested from beneath that subdirectory.
3. Make the server (run "make" in the `src` directory).

To add another module of your own:

1. `mkdir src/modules/mymodule`
2. `cp src/modules/example/* src/modules/mymodule`
3. Modify the files in the new directory.
4. Follow steps [1] through [3] above, with appropriate changes.

Using the mod_example Module

To activate the example module, include a block similar to the following in your `srm.conf` file:

```
<Location /example-info>
SetHandler example-handler
</Location>
```

As an alternative, you can put the following into a `.htaccess` (p. 302) file and then request the file "test.example" from that location:

```
AddHandler example-handler .example
```

After reloading/restarting your server, you should be able to browse to this location and see the brief display mentioned earlier.

Example Directive

Description:	Demonstration directive to illustrate the Apache module API
Syntax:	Example
Context:	server config, virtual host, directory, .htaccess
Status:	Experimental
Module:	mod_example

The **EXAMPLE** directive just sets a demonstration flag which the example module's content handler displays. It takes no arguments. If you browse to an URL to which the example content-handler applies, you will get a display of the routines within the module and how and in what order they were called to service the document request. The effect of this directive one can observe under the point "Example directive declared here: YES/NO".

10.28 Apache Module `mod_expires`

Description:	Generation of Expires and Cache-Control HTTP headers according to user-specified criteria
Status:	Extension
ModuleIdentifier:	expires_module
SourceFile:	mod_expires.c

Summary

This module controls the setting of the Expires HTTP header and the max-age directive of the Cache-Control HTTP header in server responses. The expiration date can set to be relative to either the time the source file was last modified, or to the time of the client access.

These HTTP headers are an instruction to the client about the document's validity and persistence. If cached, the document may be fetched from the cache rather than from the source until this time has passed. After that, the cache copy is considered "expired" and invalid, and a new copy must be obtained from the source.

To modify Cache-Control directives other than max-age (see RFC 2616 section 14.9¹⁶), you can use the HEADER directive.

Directives

- ExpiresActive
- ExpiresByType
- ExpiresDefault

Alternate Interval Syntax

The EXPIRESDEFAULT and EXPIRESBYTYPE directives can also be defined in a more readable syntax of the form:

```
ExpiresDefault "<base> [plus] {<num> <type>}*"
ExpiresByType type/encoding "<base> [plus] {<num> <type>}*"
```

where <base> is one of:

- access
- now (equivalent to 'access')
- modification

The plus keyword is optional. <num> should be an integer value [acceptable to atoi()], and <type> is one of:

- years
- months
- weeks
- days
- hours

¹⁶<http://www.w3.org/Protocols/rfc2616/rfc2616-sec14.html#sec14.9>

- minutes
- seconds

For example, any of the following directives can be used to make documents expire 1 month after being accessed, by default:

```
ExpiresDefault "access plus 1 month"
ExpiresDefault "access plus 4 weeks"
ExpiresDefault "access plus 30 days"
```

The expiry time can be fine-tuned by adding several '`<num> <type>`' clauses:

```
ExpiresByType text/html "access plus 1 month 15 days 2 hours"
ExpiresByType image/gif "modification plus 5 hours 3 minutes"
```

Note that if you use a modification date based setting, the Expires header will **not** be added to content that does not come from a file on disk. This is due to the fact that there is no modification time for such content.

ExpiresActive Directive

Description:	Enables generation of Expires headers
Syntax:	ExpiresActive On Off
Context:	server config, virtual host, directory, .htaccess
Override:	Indexes
Status:	Extension
Module:	mod_expires

This directive enables or disables the generation of the Expires and Cache-Control headers for the document realm in question. (That is, if found in an .htaccess file, for instance, it applies only to documents generated from that directory.) If set to Off, the headers will not be generated for any document in the realm (unless overridden at a lower level, such as an .htaccess file overriding a server config file). If set to On, the headers will be added to served documents according to the criteria defined by the EXPIRESBYTYPE and EXPIRESDEFAULT directives (*q.v.*).

Note that this directive does not guarantee that an Expires or Cache-Control header will be generated. If the criteria aren't met, no header will be sent, and the effect will be as though this directive wasn't even specified.

ExpiresByType Directive

Description:	Value of the Expires header configured by MIME type
Syntax:	ExpiresByType MIME-type <code><code></code> seconds
Context:	server config, virtual host, directory, .htaccess
Override:	Indexes
Status:	Extension
Module:	mod_expires

This directive defines the value of the Expires header and the max-age directive of the Cache-Control header generated for documents of the specified type (*e.g.*, text/html). The second argument sets the number of seconds that will be added to a base time to construct the expiration date. The Cache-Control: max-age is calculated by subtracting the request time from the expiration date and expressing the result in seconds.

The base time is either the last modification time of the file, or the time of the client's access to the document. Which should be used is specified by the `<code>` field; M means that the file's last modification time should be used as the base time, and A means the client's access time should be used.

The difference in effect is subtle. If `M` is used, all current copies of the document in all caches will expire at the same time, which can be good for something like a weekly notice that's always found at the same URL. If `A` is used, the date of expiration is different for each client; this can be good for image files that don't change very often, particularly for a set of related documents that all refer to the same images (*i.e.*, the images will be accessed repeatedly within a relatively short timespan).

Example:

```
# enable expirations
ExpiresActive On
# expire GIF images after a month in the client's cache
ExpiresByType image/gif A2592000
# HTML documents are good for a week from the
# time they were changed
ExpiresByType text/html M604800
```

Note that this directive only has effect if `ExpiresActive On` has been specified. It overrides, for the specified MIME type *only*, any expiration date set by the [EXPIRESDEFAULT](#) directive.

You can also specify the expiration time calculation using an alternate syntax, described earlier in this document.

ExpiresDefault Directive

Description:	Default algorithm for calculating expiration time
Syntax:	<code>ExpiresDefault <code>seconds</code>
Context:	server config, virtual host, directory, <code>.htaccess</code>
Override:	Indexes
Status:	Extension
Module:	<code>mod_expires</code>

This directive sets the default algorithm for calculating the expiration time for all documents in the affected realm. It can be overridden on a type-by-type basis by the [EXPIRESBYTYPE](#) directive. See the description of that directive for details about the syntax of the argument, and the alternate syntax description as well.

10.29 Apache Module mod_ext_filter

Description:	Pass the response body through an external program before delivery to the client
Status:	Extension
ModuleIdentifier:	ext_filter_module
SourceFile:	mod_ext_filter.c

Summary

[MOD_EXT_FILTER](#) presents a simple and familiar programming model for filters (p. 67) . With this module, a program which reads from stdin and writes to stdout (i.e., a Unix-style filter command) can be a filter for Apache. This filtering mechanism is much slower than using a filter which is specially written for the Apache API and runs inside of the Apache server process, but it does have the following benefits:

- the programming model is much simpler
- any programming/scripting language can be used, provided that it allows the program to read from standard input and write to standard output
- existing programs can be used unmodified as Apache filters

Even when the performance characteristics are not suitable for production use, [MOD_EXT_FILTER](#) can be used as a prototype environment for filters.

Directives

- ExtFilterDefine
- ExtFilterOptions

See also

- Filters (p. 67)

Examples

Generating HTML from some other type of response

```
# mod_ext_filter directive to define a filter
# to HTML-ize text/c files using the external
# program /usr/bin/enscript, with the type of
# the result set to text/html
ExtFilterDefine c-to-html mode=output \
    intype=text/c outtype=text/html \
    cmd="/usr/bin/enscript --color -W html -Ec -o - -"
<Directory "/export/home/trawick/apacheinst/htdocs/c">
    # core directive to cause the new filter to
    # be run on output
    SetOutputFilter c-to-html

    # mod_mime directive to set the type of .c
    # files to text/c
    AddType text/c .c

    # mod_ext_filter directive to set the debug
    # level just high enough to see a log message
    # per request showing the configuration in force
    ExtFilterOptions DebugLevel=1
</Directory>
```

Implementing a content encoding filter

Note: this gzip example is just for the purposes of illustration. Please refer to [MOD_DEFLATE](#) for a practical implementation.

```
# mod_ext_filter directive to define the external filter
ExtFilterDefine gzip mode=output cmd=/bin/gzip
<Location /gzipped>
    # core directive to cause the gzip filter to be
    # run on output
    SetOutputFilter gzip

    # mod_header directive to add
    # "Content-Encoding: gzip" header field
    Header set Content-Encoding gzip
</Location>
```

Slowing down the server

```
# mod_ext_filter directive to define a filter
# which runs everything through cat; cat doesn't
# modify anything; it just introduces extra pathlength
# and consumes more resources
ExtFilterDefine slowdown mode=output cmd=/bin/cat \
    preservescontentlength
<Location />
    # core directive to cause the slowdown filter to
    # be run several times on output
    #
    SetOutputFilter slowdown;slowdown;slowdown
</Location>
```

Using sed to replace text in the response

```
# mod_ext_filter directive to define a filter which
# replaces text in the response
#
ExtFilterDefine fixtext mode=output intype=text/html \
    cmd="/bin/sed s/verdana/arial/g"
<Location />
    # core directive to cause the fixtext filter to
    # be run on output
    SetOutputFilter fixtext
</Location>
```

Tracing another filter

```

# Trace the data read and written by mod.deflate
# for a particular client (IP 192.168.1.31)
# experiencing compression problems.
# This filter will trace what goes into mod.deflate.
ExtFilterDefine tracebefore \
    cmd="/bin/tracefilter.pl /tmp/tracebefore" \
    EnableEnv=trace_this_client

# This filter will trace what goes after mod.deflate.
# Note that without the ftype parameter, the default
# filter type of AP_FTYPE_RESOURCE would cause the
# filter to be placed *before* mod.deflate in the filter
# chain. Giving it a numeric value slightly higher than
# AP_FTYPE_CONTENT_SET will ensure that it is placed
# after mod.deflate.
ExtFilterDefine traceafter \
    cmd="/bin/tracefilter.pl /tmp/traceafter" \
    EnableEnv=trace_this_client ftype=21

<Directory /usr/local/docs>
    SetEnvIf Remote_Addr 192.168.1.31 trace_this_client
    SetOutputFilter tracebefore;deflate;traceafter
</Directory>

```

Here is the filter which traces the data:

```

#!/usr/local/bin/perl -w
use strict;
open(SAVE, ">$ARGV[0]")
    or die "can't open $ARGV[0]: $?";
while (<STDIN>) {
    print SAVE $_;
    print $_;
}
close(SAVE);

```

ExtFilterDefine Directive

Description:	Define an external filter
Syntax:	ExtFilterDefine filtername parameters
Context:	server config
Status:	Extension
Module:	mod_ext_filter

The **EXTFILTERDEFINE** directive defines the characteristics of an external filter, including the program to run and its arguments.

filtername specifies the name of the filter being defined. This name can then be used in SetOutputFilter directives. It must be unique among all registered filters. *At the present time, no error is reported by the register-filter API, so a problem with duplicate names isn't reported to the user.*

Subsequent parameters can appear in any order and define the external command to run and certain other characteristics. The only required parameter is cmd=. These parameters are:

cmd=cmdline The `cmd=` keyword allows you to specify the external command to run. If there are arguments after the program name, the command line should be surrounded in quotation marks (e.g., `cmd="/bin/mypgm arg1 arg2"`). Normal shell quoting is not necessary since the program is run directly, bypassing the shell. Program arguments are blank-delimited. A backslash can be used to escape blanks which should be part of a program argument. Any backslashes which are part of the argument must be escaped with backslash themselves. In addition to the standard CGI environment variables, `DOCUMENT_URI`, `DOCUMENT_PATH_INFO`, and `QUERY_STRING_UNESCAPED` will also be set for the program.

mode=mode `mode` should be `output` for now (the default). In the future, `mode=input` will be used to specify a filter for request bodies.

intype=imt This parameter specifies the internet media type (i.e., MIME type) of documents which should be filtered. By default, all documents are filtered. If `intype=` is specified, the filter will be disabled for documents of other types.

outtype=imt This parameter specifies the internet media type (i.e., MIME type) of filtered documents. It is useful when the filter changes the internet media type as part of the filtering operation. By default, the internet media type is unchanged.

PreservesContentLength The `PreservesContentLength` keyword specifies that the filter preserves the content length. This is not the default, as most filters change the content length. In the event that the filter doesn't modify the length, this keyword should be specified.

ftype=filtertype This parameter specifies the numeric value for filter type that the filter should be registered as. The default value, `AP_FTYPE_RESOURCE`, is sufficient in most cases. If the filter needs to operate at a different point in the filter chain than resource filters, then this parameter will be necessary. See the `AP_FTYPE_foo` definitions in `util_filter.h` for appropriate values.

disableenv=env This parameter specifies the name of an environment variable which, if set, will disable the filter.

enableenv=env This parameter specifies the name of an environment variable which must be set, or the filter will be disabled.

ExtFilterOptions Directive

Description:	Configure MOD_EXT_FILTER options
Syntax:	<code>ExtFilterOptions option [option] ...</code>
Default:	<code>ExtFilterOptions DebugLevel=0 NoLogStderr</code>
Context:	directory
Status:	Extension
Module:	<code>mod_ext_filter</code>

The [EXTFILTEROPTIONS](#) directive specifies special processing options for [MOD_EXT_FILTER](#). Option can be one of

DebugLevel=n The `DebugLevel` keyword allows you to specify the level of debug messages generated by [MOD_EXT_FILTER](#). By default, no debug messages are generated. This is equivalent to `DebugLevel=0`. With higher numbers, more debug messages are generated, and server performance will be degraded. The actual meanings of the numeric values are described with the definitions of the `DBGLVL_` constants near the beginning of `mod_ext_filter.c`.

Note: The core directive [LOGLEVEL](#) should be used to cause debug messages to be stored in the Apache error log.

LogStderr | **NoLogStderr** The `LogStderr` keyword specifies that messages written to standard error by the external filter program will be saved in the Apache error log. `NoLogStderr` disables this feature.

Example

```
ExtFilterOptions LogStderr DebugLevel=0
```

Messages written to the filter's standard error will be stored in the Apache error log. No debug messages will be generated by [MOD_EXT_FILTER](#).

10.30 Apache Module mod_file_cache

Description:	Caches a static list of files in memory
Status:	Experimental
ModuleIdentifier:	file_cache_module
SourceFile:	mod_file_cache.c

Summary



This module should be used with care. You can easily create a broken site using [MOD_FILE_CACHE](#), so read this document carefully.

Caching frequently requested files that change very infrequently is a technique for reducing server load. [MOD_FILE_CACHE](#) provides two techniques for caching frequently requested *static* files. Through configuration directives, you can direct [MOD_FILE_CACHE](#) to either open then `mmap()` a file, or to pre-open a file and save the file's open *file handle*. Both techniques reduce server load when processing requests for these files by doing part of the work (specifically, the file I/O) for serving the file when the server is started rather than during each request.

Notice: You cannot use this for speeding up CGI programs or other files which are served by special content handlers. It can only be used for regular files which are usually served by the Apache core content handler.

This module is an extension of and borrows heavily from the `mod_mmap_static` module in Apache 1.3.

Directives

- CacheFile
- MMapFile

Using mod_file_cache

[MOD_FILE_CACHE](#) caches a list of statically configured files via [MMAPFILE](#) or [CACHEFILE](#) directives in the main server configuration.

Not all platforms support both directives. For example, Apache on Windows does not currently support the [MMAP-STATIC](#) directive, while other platforms, like AIX, support both. You will receive an error message in the server error log if you attempt to use an unsupported directive. If given an unsupported directive, the server will start but the file will not be cached. On platforms that support both directives, you should experiment with both to see which works best for you.

MMapFile Directive

The [MMAPFILE](#) directive of [MOD_FILE_CACHE](#) maps a list of statically configured files into memory through the system call `mmap()`. This system call is available on most modern Unix derivatives, but not on all. There are sometimes system-specific limits on the size and number of files that can be `mmap()`ed, experimentation is probably the easiest way to find out.

This `mmap()`ing is done once at server start or restart, only. So whenever one of the mapped files changes on the filesystem you *have* to restart the server (see the Stopping and Restarting (p. 16) documentation). To reiterate that point: if the files are modified *in place* without restarting the server you may end up serving requests that are completely bogus. You should update files by unlinking the old copy and putting a new copy in place. Most tools such as `rdist` and `mv` do this. The reason why this modules doesn't take care of changes to the files is that this check would need an extra `stat()` every time which is a waste and against the intent of I/O reduction.

CacheFile Directive

The `CACHEFILE` directive of `MOD_FILE_CACHE` opens an active *handle* or *file descriptor* to the file (or files) listed in the configuration directive and places these open file handles in the cache. When the file is requested, the server retrieves the handle from the cache and passes it to the `sendfile()` (or `TransmitFile()` on Windows), socket API.

This file handle caching is done once at server start or restart, only. So whenever one of the cached files changes on the filesystem you *have* to restart the server (see the Stopping and Restarting (p. 16) documentation). To reiterate that point: if the files are modified *in place* without restarting the server you may end up serving requests that are completely bogus. You should update files by unlinking the old copy and putting a new copy in place. Most tools such as `rdist` and `mv` do this.



Note

Don't bother asking for a directive which recursively caches all the files in a directory. Try this instead... See the `INCLUDE` directive, and consider this command:

```
find /www/htdocs -type f -print \  
| sed -e 's/./mmapfile &/' > /www/conf/mmap.conf
```

CacheFile Directive

Description:	Cache a list of file handles at startup time
Syntax:	<code>CacheFile file-path [file-path] ...</code>
Context:	server config
Status:	Experimental
Module:	<code>mod_file_cache</code>

The `CACHEFILE` directive opens handles to one or more files (given as whitespace separated arguments) and places these handles into the cache at server startup time. Handles to cached files are automatically closed on a server shutdown. When the files have changed on the filesystem, the server should be restarted to re-cache them.

Be careful with the file-path arguments: They have to literally match the filesystem path Apache's URL-to-filename translation handlers create. We cannot compare inodes or other stuff to match paths through symbolic links *etc.* because that again would cost extra `stat()` system calls which is not acceptable. This module may or may not work with filenames rewritten by `MOD_ALIAS` or `MOD_REWRITE`.

Example

```
CacheFile /usr/local/apache/htdocs/index.html
```

MMapFile Directive

Description:	Map a list of files into memory at startup time
Syntax:	<code>MMapFile file-path [file-path] ...</code>
Context:	server config
Status:	Experimental
Module:	<code>mod_file_cache</code>

The `MMAPFILE` directive maps one or more files (given as whitespace separated arguments) into memory at server startup time. They are automatically unmapped on a server shutdown. When the files have changed on the filesystem at least a HUP or USR1 signal should be send to the server to `re-mmap()` them.

Be careful with the file-path arguments: They have to literally match the filesystem path Apache's URL-to-filename translation handlers create. We cannot compare inodes or other stuff to match paths through symbolic links *etc.* because that again would cost extra `stat()` system calls which is not acceptable. This module may or may not work with filenames rewritten by [MOD_ALIAS](#) or [MOD_REWRITE](#).

Example

```
MMapFile /usr/local/apache/htdocs/index.html
```

10.31 Apache Module `mod_headers`

Description:	Customization of HTTP request and response headers
Status:	Extension
ModuleIdentifier:	<code>headers_module</code>
SourceFile:	<code>mod_headers.c</code>
Compatibility:	REQUESTHEADER is available only in Apache 2.0

Summary

This module provides directives to control and modify HTTP request and response headers. Headers can be merged, replaced or removed.

Directives

- `Header`
- `RequestHeader`

Order of Processing

The directives provided by [MOD_HEADERS](#) can occur almost anywhere within the server configuration. They are valid in the main server config and virtual host sections, inside `<DIRECTORY>`, `<LOCATION>` and `<FILES>` sections, and within `.htaccess` files.

The directives are processed in the following order:

1. main server
2. virtual host
3. `<DIRECTORY>` sections and `.htaccess`
4. `<FILES>`
5. `<LOCATION>`

Order is important. These two headers have a different effect if reversed:

```
RequestHeader append MirrorID "mirror 12"
RequestHeader unset MirrorID
```

This way round, the `MirrorID` header is not set. If reversed, the `MirrorID` header is set to "mirror 12".

Examples

1. Copy all request headers that begin with "TS" to the response headers:

```
Header echo ^TS
```

2. Add a header, `MyHeader`, to the response including a timestamp for when the request was received and how long it took to begin serving the request. This header can be used by the client to intuit load on the server or in isolating bottlenecks between the client and the server.

```
Header add MyHeader "%D %t"
```

results in this header being added to the response:

```
MyHeader: D=3775428 t=991424704447256
```

3. Say hello to Joe

```
Header add MyHeader "Hello Joe. It took %D microseconds \
for Apache to serve this request."
```

results in this header being added to the response:

```
MyHeader: Hello Joe. It took D=3775428 microseconds for Apache to
serve this request.
```

4. Conditionally send `MyHeader` on the response if and only if header "`MyRequestHeader`" is present on the request. This is useful for constructing headers in response to some client stimulus. Note that this example requires the services of the [MOD_SETENVIF](#) module.

```
SetEnvIf MyRequestHeader value HAVE_MyRequestHeader
Header add MyHeader "%D %t mytext" env=HAVE_MyRequestHeader
```

If the header `MyRequestHeader: value` is present on the HTTP request, the response will contain the following header:

```
MyHeader: D=3775428 t=991424704447256 mytext
```

Header Directive

Description:	Configure HTTP response headers
Syntax:	Header [condition] set append add unset echo header [value] [env=[!]variable]
Context:	server config, virtual host, directory, .htaccess
Override:	FileInfo
Status:	Extension
Module:	mod_headers
Compatibility:	Condition is available in version 2.0.51 and later

This directive can replace, merge or remove HTTP response headers. The header is modified just after the content handler and output filters are run, allowing outgoing headers to be modified.

The optional condition can be either `onsuccess` or `always`. It determines, which internal header table should be operated on. `onsuccess` stands for `2xx` status codes and `always` for all status codes (including `2xx`). Especially if you want to unset headers set by certain modules, you should try out, which table is affected.

The action it performs is determined by the second argument. This can be one of the following values:

- set** The response header is set, replacing any previous header with this name. The value may be a format string.
- append** The response header is appended to any existing header of the same name. When a new value is merged onto an existing header it is separated from the existing header with a comma. This is the HTTP standard way of giving a header multiple values.
- add** The response header is added to the existing set of headers, even if this header already exists. This can result in two (or more) headers having the same name. This can lead to unforeseen consequences, and in general "append" should be used instead.
- unset** The response header of this name is removed, if it exists. If there are multiple headers of the same name, all will be removed.
- echo** Request headers with this name are echoed back in the response headers. header may be a regular expression.

This argument is followed by a header name, which can include the final colon, but it is not required. Case is ignored for `set`, `append`, `add` and `unset`. The header name for `echo` is case sensitive and may be a regular expression.

For `add`, `append` and `set` a value is specified as the third argument. If value contains spaces, it should be surrounded by doublequotes. value may be a character string, a string containing format specifiers or a combination of both. The following format specifiers are supported in value:

<code>%t</code>	The time the request was received in Universal Coordinated Time since the epoch (Jan. 1, 1970) measured in microseconds. The value is preceded by <code>t=</code> .
<code>%D</code>	The time from when the request was received to the time the headers are sent on the wire. This is a measure of the duration of the request. The value is preceded by <code>D=</code> .
<code>%{FOOBAR}e</code>	The contents of the environment variable (p. 60) <code>FOOBAR</code> .

When the `HEADER` directive is used with the `add`, `append`, or `set` argument, a fourth argument may be used to specify conditions under which the action will be taken. If the environment variable (p. 60) specified in the `env=...` argument exists (or if the environment variable does not exist and `env=!...` is specified) then the action specified by the `HEADER` directive will take effect. Otherwise, the directive will have no effect on the request.

The `HEADER` directives are processed just before the response is sent to the network. These means that it is possible to set and/or override most headers, except for those headers added by the header filter.

RequestHeader Directive

Description:	Configure HTTP request headers
Syntax:	<code>RequestHeader set append add unset header [value [env=[!]variable]]</code>
Context:	server config, virtual host, directory, <code>.htaccess</code>
Override:	FileInfo
Status:	Extension
Module:	<code>mod_headers</code>

This directive can replace, merge or remove HTTP request headers. The header is modified just before the content handler is run, allowing incoming headers to be modified. The action it performs is determined by the first argument. This can be one of the following values:

- set** The request header is set, replacing any previous header with this name
- append** The request header is appended to any existing header of the same name. When a new value is merged onto an existing header it is separated from the existing header with a comma. This is the HTTP standard way of giving a header multiple values.

add The request header is added to the existing set of headers, even if this header already exists. This can result in two (or more) headers having the same name. This can lead to unforeseen consequences, and in general `append` should be used instead.

unset The request header of this name is removed, if it exists. If there are multiple headers of the same name, all will be removed.

This argument is followed by a header name, which can include the final colon, but it is not required. Case is ignored. For `add`, `append` and `set` a value is given as the third argument. If value contains spaces, it should be surrounded by double quotes. For `unset`, no value should be given.

When the `REQUESTHEADER` directive is used with the `add`, `append`, or `set` argument, a fourth argument may be used to specify conditions under which the action will be taken. If the environment variable (p. 60) specified in the `env=...` argument exists (or if the environment variable does not exist and `env=!...` is specified) then the action specified by the `REQUESTHEADER` directive will take effect. Otherwise, the directive will have no effect on the request.

The `REQUESTHEADER` directive is processed just before the request is run by its handler in the fixup phase. This should allow headers generated by the browser, or by Apache input filters to be overridden or modified.

10.32 Apache Module mod_imap

Description:	Server-side imagemap processing
Status:	Base
ModuleIdentifier:	imap_module
SourceFile:	mod_imap.c

Summary

This module processes `.map` files, thereby replacing the functionality of the `imagemap` CGI program. Any directory or document type configured to use the handler `imap-file` (using either [ADDHANDLER](#) or [SETHANDLER](#)) will be processed by this module.

The following directive will activate files ending with `.map` as `imagemap` files:

```
AddHandler imap-file map
```

Note that the following is still supported:

```
AddType application/x-httpd-imap map
```

However, we are trying to phase out "magic MIME types" so we are deprecating this method.

Directives

- `ImapBase`
- `ImapDefault`
- `ImapMenu`

New Features

The `imagemap` module adds some new features that were not possible with previously distributed `imagemap` programs.

- URL references relative to the `Referer`: information.
- Default `<base>` assignment through a new `map` directive `base`.
- No need for `imagemap.conf` file.
- Point references.
- Configurable generation of `imagemap` menus.

Imagemap File

The lines in the `imagemap` files can have one of several formats:

```
directive value [x,y ...]
directive value "Menu text" [x,y ...]
directive value x,y ... "Menu text"
```

The directive is one of `base`, `default`, `poly`, `circle`, `rect`, or `point`. The value is an absolute or relative URL, or one of the special values listed below. The coordinates are `x, y` pairs separated by whitespace. The quoted text is used as the text of the link if a `imagemap` menu is generated. Lines beginning with `#` are comments.

Imagemap File Directives

There are six directives allowed in the imagemap file. The directives can come in any order, but are processed in the order they are found in the imagemap file.

base Directive Has the effect of `<base href="value">` . The non-absolute URLs of the map-file are taken relative to this value. The base directive overrides `IMAPBASE` as set in a `.htaccess` file or in the server configuration files. In the absence of an `IMAPBASE` configuration directive, base defaults to `http://server_name/`.

`base_uri` is synonymous with `base`. Note that a trailing slash on the URL is significant.

default Directive The action taken if the coordinates given do not fit any of the `poly`, `circle` or `rect` directives, and there are no `point` directives. Defaults to `nocontent` in the absence of an `IMAPDEFAULT` configuration setting, causing a status code of 204 No Content to be returned. The client should keep the same page displayed.

poly Directive Takes three to one-hundred points, and is obeyed if the user selected coordinates fall within the polygon defined by these points.

circle Takes the center coordinates of a circle and a point on the circle. Is obeyed if the user selected point is with the circle.

rect Directive Takes the coordinates of two opposing corners of a rectangle. Obeyed if the point selected is within this rectangle.

point Directive Takes a single point. The point directive closest to the user selected point is obeyed if no other directives are satisfied. Note that `default` will not be followed if a `point` directive is present and valid coordinates are given.

Values

The values for each of the directives can any of the following:

a URL The URL can be relative or absolute URL. Relative URLs can contain `'..'` syntax and will be resolved relative to the `base` value.

`base` itself will not resolved according to the current value. A statement `base mailto:` will work properly, though.

map Equivalent to the URL of the imagemap file itself. No coordinates are sent with this, so a menu will be generated unless `IMAPMENU` is set to `none`.

menu Synonymous with `map`.

referer Equivalent to the URL of the referring document. Defaults to `http://servername/` if no `Referer:` header was present.

nocontent Sends a status code of 204 No Content, telling the client to keep the same page displayed. Valid for all but `base`.

error Fails with a 500 Server Error. Valid for all but `base`, but sort of silly for anything but `default`.

Coordinates

0, 0 200, 200 A coordinate consists of an x and a y value separated by a comma. The coordinates are separated from each other by whitespace. To accommodate the way Lynx handles imagemaps, should a user select the coordinate 0, 0, it is as if no coordinate had been selected.

Quoted Text

"Menu Text" After the value or after the coordinates, the line optionally may contain text within double quotes. This string is used as the text for the link if a menu is generated:

```
<a href="http://foo.com/">Menu text</a>
```

If no quoted text is present, the name of the link will be used as the text:

```
<a href="http://foo.com/">http://foo.com</a>
```

If you want to use double quotes within this text, you have to write them as `"`;

Example Mapfile

```
#Comments are printed in a 'formatted' or 'semiformatted' menu.
#And can contain html tags. <hr>
base referer
poly map "Could I have a menu, please?" 0,0 0,10 10,10 10,0
rect .. 0,0 77,27 "the directory of the referer"
circle http://www.inetnebr.com/lincoln/feedback/ 195,0 305,27
rect another_file "in same directory as referer" 306,0 419,27
point http://www.zyzyva.com/ 100,100
point http://www.tripod.com/ 200,200
rect mailto:nate@tripod.com 100,150 200,0 "Bugs?"
```

Referencing your mapfile

HTML example

```
<a href="/maps/imagemap1.map">
  
</a>
```

XHTML example

```
<a href="/maps/imagemap1.map">
  
</a>
```

ImapBase Directive

Description:	Default base for imagemap files
Syntax:	ImapBase map referer URL
Default:	ImapBase http://servername/
Context:	server config, virtual host, directory, .htaccess
Override:	Indexes
Status:	Base
Module:	mod_imap

The **IMAPBASE** directive sets the default `base` used in the imagemap files. Its value is overridden by a `base` directive within the imagemap file. If not present, the `base` defaults to `http://servername/`.

See also

- [USECANONICALNAME](#)

ImapDefault Directive

Description:	Default action when an imagemap is called with coordinates that are not explicitly mapped
Syntax:	<code>ImapDefault error nocontent map referer URL</code>
Default:	<code>ImapDefault nocontent</code>
Context:	server config, virtual host, directory, <code>.htaccess</code>
Override:	Indexes
Status:	Base
Module:	<code>mod_imap</code>

The **IMAPDEFAULT** directive sets the default `default` used in the imagemap files. Its value is overridden by a `default` directive within the imagemap file. If not present, the `default` action is `nocontent`, which means that a 204 No Content is sent to the client. In this case, the client should continue to display the original page.

ImapMenu Directive

Description:	Action if no coordinates are given when calling an imagemap
Syntax:	<code>ImapMenu none formatted semiformatted unformatted</code>
Context:	server config, virtual host, directory, <code>.htaccess</code>
Override:	Indexes
Status:	Base
Module:	<code>mod_imap</code>

The **IMAPMENU** directive determines the action taken if an imagemap file is called without valid coordinates.

none If `ImapMenu` is `none`, no menu is generated, and the `default` action is performed.

formatted A `formatted` menu is the simplest menu. Comments in the imagemap file are ignored. A level one header is printed, then an hrule, then the links each on a separate line. The menu has a consistent, plain look close to that of a directory listing.

semiformatted In the `semiformatted` menu, comments are printed where they occur in the imagemap file. Blank lines are turned into HTML breaks. No header or hrule is printed, but otherwise the menu is the same as a `formatted` menu.

unformatted Comments are printed, blank lines are ignored. Nothing is printed that does not appear in the imagemap file. All breaks and headers must be included as comments in the imagemap file. This gives you the most flexibility over the appearance of your menus, but requires you to treat your map files as HTML instead of plaintext.

10.33 Apache Module `mod_include`

Description:	Server-parsed html documents (Server Side Includes)
Status:	Base
ModuleIdentifier:	<code>include_module</code>
SourceFile:	<code>mod_include.c</code>
Compatibility:	Implemented as an output filter since Apache 2.0

Summary

This module provides a filter which will process files before they are sent to the client. The processing is controlled by specially formatted SGML comments, referred to as elements. These elements allow conditional text, the inclusion of other files or programs, as well as the setting and printing of environment variables.

Directives

- `SSIEndTag`
- `SSIErrorMsg`
- `SSIStartTag`
- `SSITimeFormat`
- `SSIUndefinedEcho`
- `XBitHack`

See also

- [OPTIONS](#)
- [ACCEPTPATHINFO](#)
- International Customized Server Error Messages (p. 273)
- Filters (p. 67)
- SSI Tutorial (p. 191)

Enabling Server-Side Includes

Server Side Includes are implemented by the `INCLUDES` filter (p. 67) . If documents containing server-side include directives are given the extension `.shtml`, the following directives will make Apache parse them and assign the resulting document the mime type of `text/html`:

```
AddType text/html .shtml
AddOutputFilter INCLUDES .shtml
```

The following directive must be given for the directories containing the `shtml` files (typically in a `<DIRECTORY>` section, but this directive is also valid in `.htaccess` files if `ALLOWOVERRIDE` Options is set):

```
Options +Includes
```

For backwards compatibility, the `server-parsed` handler (p. 65) also activates the `INCLUDES` filter. As well, Apache will activate the `INCLUDES` filter for any document with mime type `text/x-server-parsed-html` or `text/x-server-parsed-html3` (and the resulting output will have the mime type `text/html`).

For more information, see our Tutorial on Server Side Includes (p. 191) .

PATH_INFO with Server Side Includes

Files processed for server-side includes no longer accept requests with `PATH_INFO` (trailing pathname information) by default. You can use the `ACCEPTPATHINFO` directive to configure the server to accept requests with `PATH_INFO`.

Basic Elements

The document is parsed as an HTML document, with special commands embedded as SGML comments. A command has the syntax:

```
<!--#element attribute=value attribute=value ... -->
```

The value will often be enclosed in double quotes, but single quotes (') and backticks (`) are also possible. Many commands only allow a single attribute-value pair. Note that the comment terminator (`-->`) should be preceded by whitespace to ensure that it isn't considered part of an SSI token. Note that the leading `<!--#` is *one* token and may not contain any whitespaces.

The allowed elements are listed in the following table:

Element	Description
<code>config</code>	configure output formats
<code>echo</code>	print variables
<code>exec</code>	execute external programs
<code>fsize</code>	print size of a file
<code>flastmod</code>	print last modification time of a file
<code>include</code>	include a file
<code>printenv</code>	print all available variables
<code>set</code>	set a value of a variable

SSI elements may be defined by modules other than `MOD_INCLUDE`. In fact, the `exec` element is provided by `MOD_CGI`, and will only be available if this module is loaded.

The config Element

This command controls various aspects of the parsing. The valid attributes are:

errmsg The value is a message that is sent back to the client if an error occurs while parsing the document. This overrides any `SSIERRORMSG` directives.

sizefmt The value sets the format to be used which displaying the size of a file. Valid values are `bytes` for a count in bytes, or `abbrev` for a count in Kb or Mb as appropriate, for example a size of 1024 bytes will be printed as "1K".

timefmt The value is a string to be used by the `strftime(3)` library routine when printing dates.

The echo Element

This command prints one of the include variables, defined below. If the variable is unset, the result is determined by the `SSIUNDEFINEDECHO` directive. Any dates printed are subject to the currently configured `timefmt`.

Attributes:

var The value is the name of the variable to print.

encoding Specifies how Apache should encode special characters contained in the variable before outputting them. If set to `none`, no encoding will be done. If set to `url`, then URL encoding (also known as %-encoding; this is appropriate for use within URLs in links, etc.) will be performed. At the start of an `echo` element, the default is set to `entity`, resulting in entity encoding (which is appropriate in the context of a block-level HTML element, e.g. a paragraph of text). This can be changed by adding an `encoding` attribute, which will remain in effect until the next `encoding` attribute is encountered or the element ends, whichever comes first.

The `encoding` attribute must *precede* the corresponding `var` attribute to be effective, and only special characters as defined in the ISO-8859-1 character encoding will be encoded. This encoding process may not have the desired result if a different character encoding is in use.



In order to avoid cross-site scripting issues, you should *always* encode user supplied data.

The `exec` Element

The `exec` command executes a given shell command or CGI script. It requires `MOD_CGI` to be present in the server. If `OPTIONS IncludesNOEXEC` is set, this command is completely disabled. The valid attributes are:

cgi The value specifies a (%-encoded) URL-path to the CGI script. If the path does not begin with a slash (/), then it is taken to be relative to the current document. The document referenced by this path is invoked as a CGI script, even if the server would not normally recognize it as such. However, the directory containing the script must be enabled for CGI scripts (with `SCRIPTALIAS` or `OPTIONS ExecCGI`).

The CGI script is given the `PATH_INFO` and query string (`QUERY_STRING`) of the original request from the client; these *cannot* be specified in the URL path. The include variables will be available to the script in addition to the standard CGI (p. 399) environment.

Example

```
<!--#exec cgi="/cgi-bin/example.cgi" -->
```

If the script returns a `Location:` header instead of output, then this will be translated into an HTML anchor.

The `include virtual` element should be used in preference to `exec cgi`. In particular, if you need to pass additional arguments to a CGI program, using the query string, this cannot be done with `exec cgi`, but can be done with `include virtual`, as shown here:

```
<!--#include virtual="/cgi-bin/example.cgi?argument=value" -->
```

cmd The server will execute the given string using `/bin/sh`. The include variables are available to the command, in addition to the usual set of CGI variables.

The use of `#include virtual` is almost always preferred to using either `#exec cgi` or `#exec cmd`. The former (`#include virtual`) uses the standard Apache sub-request mechanism to include files or scripts. It is much better tested and maintained.

In addition, on some platforms, like Win32, and on unix when using `suexec` (p. 68), you cannot pass arguments to a command in an `exec` directive, or otherwise include spaces in the command. Thus, while the following will work under a non-`suexec` configuration on unix, it will not produce the desired result under Win32, or when running `suexec`:

```
<!--#exec cmd="perl /path/to/perlscript arg1 arg2" -->
```

The `filesize` Element

This command prints the size of the specified file, subject to the `sizefmt` format specification. Attributes:

file The value is a path relative to the directory containing the current document being parsed.

virtual The value is a (%-encoded) URL-path. If it does not begin with a slash (/) then it is taken to be relative to the current document. Note, that this does *not* print the size of any CGI output, but the size of the CGI script itself.

The `flastmod` Element

This command prints the last modification date of the specified file, subject to the `timefmt` format specification. The attributes are the same as for the `filesize` command.

The `include` Element

This command inserts the text of another document or file into the parsed file. Any included file is subject to the usual access control. If the directory containing the parsed file has Options (p. 302) `IncludesNOEXEC` set, then only documents with a text MIME type (`text/plain`, `text/html` etc.) will be included. Otherwise CGI scripts are invoked as normal using the complete URL given in the command, including any query string.

An attribute defines the location of the document; the inclusion is done for each attribute given to the `include` command. The valid attributes are:

file The value is a path relative to the directory containing the current document being parsed. It cannot contain `../`, nor can it be an absolute path. Therefore, you cannot include files that are outside of the document root, or above the current document in the directory structure. The `virtual` attribute should always be used in preference to this one.

virtual The value is a (%-encoded) URL-path. The URL cannot contain a scheme or hostname, only a path and an optional query string. If it does not begin with a slash (/) then it is taken to be relative to the current document.

A URL is constructed from the attribute, and the output the server would return if the URL were accessed by the client is included in the parsed output. Thus included files can be nested.

If the specified URL is a CGI program, the program will be executed and its output inserted in place of the directive in the parsed file. You may include a query string in a CGI url:

```
<!--#include virtual="/cgi-bin/example.cgi?argument=value" -->
```

`include virtual` should be used in preference to `exec cgi` to include the output of CGI programs into an HTML document.

The `printenv` Element

This prints out a listing of all existing variables and their values. Special characters are entity encoded (see the `echo` element for details) before being output. There are no attributes.

Example

```
<!--#printenv -->
```

The set Element

This sets the value of a variable. Attributes:

var The name of the variable to set.

value The value to give a variable.

Example

```
<!--#set var="category" value="help" -->
```

Include Variables

In addition to the variables in the standard CGI environment, these are available for the `echo` command, for `if` and `elif`, and to any program invoked by the document.

DATE_GMT The current date in Greenwich Mean Time.

DATE_LOCAL The current date in the local time zone.

DOCUMENT_NAME The filename (excluding directories) of the document requested by the user.

DOCUMENT_URI The (%-decoded) URL path of the document requested by the user. Note that in the case of nested include files, this is *not* the URL for the current document.

LAST_MODIFIED The last modification date of the document requested by the user.

QUERY_STRING_UNESCAPED If a query string is present, this variable contains the (%-decoded) query string, which is *escaped* for shell usage (special characters like `&` etc. are preceded by backslashes).

Variable Substitution

Variable substitution is done within quoted strings in most cases where they may reasonably occur as an argument to an SSI directive. This includes the `config`, `exec`, `flastmod`, `fsize`, `include`, `echo`, and `set` directives, as well as the arguments to conditional operators. You can insert a literal dollar sign into the string using backslash quoting:

```
<!--#if expr="$a = \$test" -->
```

If a variable reference needs to be substituted in the middle of a character sequence that might otherwise be considered a valid identifier in its own right, it can be disambiguated by enclosing the reference in braces, *a la* shell substitution:

```
<!--#set var="Zed" value="\${REMOTE_HOST}-${REQUEST_METHOD}" -->
```

This will result in the `Zed` variable being set to `"X.Y"` if `REMOTE_HOST` is `"X"` and `REQUEST_METHOD` is `"Y"`.

The below example will print `"in foo"` if the `DOCUMENT_URI` is `/foo/file.html`, `"in bar"` if it is `/bar/file.html` and `"in neither"` otherwise:

```

<!--#if expr="$DOCUMENT_URI" = "/foo/file.html" -->
    in foo
<!--#elif expr="$DOCUMENT_URI" = "/bar/file.html" -->
    in bar
<!--#else -->
    in neither
<!--#endif -->

```

Flow Control Elements

The basic flow control elements are:

```

<!--#if expr="test_condition" -->
<!--#elif expr="test_condition" -->
<!--#else -->
<!--#endif -->

```

The `if` element works like an `if` statement in a programming language. The test condition is evaluated and if the result is true, then the text until the next `elif`, `else` or `endif` element is included in the output stream.

The `elif` or `else` statements are be used to put text into the output stream if the original `test_condition` was false. These elements are optional.

The `endif` element ends the `if` element and is required.

`test_condition` is one of the following:

string true if string is not empty

string1 = string2 **string1 != string2** Compare `string1` with `string2`. If `string2` has the form `/string2/` then it is treated as a regular expression. Regular expressions are implemented by the PCRE¹⁷ engine and have the same syntax as those in perl 5¹⁸.

If you are matching positive (`=`), you can capture grouped parts of the regular expression. The captured parts are stored in the special variables `$1 .. $9`.

Example

```

<!--#if expr="$QUERY_STRING = /^sid=([a-zA-Z0-9]+)/" -->
    <!--#set var="session" value="$1" -->
<!--#endif -->

```

string1 < string2 **string1 <= string2** **string1 > string2** **string1 >= string2** Compare `string1` with `string2`. Note, that strings are compared *literally* (using `strcmp(3)`). Therefore the string "100" is less than "20".

(test_condition) true if `test_condition` is true

! test_condition true if `test_condition` is false

test_condition1 && test_condition2 true if both `test_condition1` and `test_condition2` are true

¹⁷<http://www.pcre.org>

¹⁸<http://www.perl.com>

test_condition1 || test_condition2 true if either test_condition1 or test_condition2 is true

"=" and "!=" bind more tightly than "&&" and "||". "!" binds most tightly. Thus, the following are equivalent:

```
<!--#if expr="$a = test1 && $b = test2" -->
<!--#if expr="($a = test1) && ($b = test2)" -->
```

The boolean operators && and || share the same priority. So if you want to bind such an operator more tightly, you should use parentheses.

Anything that's not recognized as a variable or an operator is treated as a string. Strings can also be quoted: 'string'. Unquoted strings can't contain whitespace (blanks and tabs) because it is used to separate tokens such as variables. If multiple strings are found in a row, they are concatenated using blanks. So,

```
string1string2 results in string1string2
and
'string1string2' results in string1string2.
```

SSIEndTag Directive

Description:	String that ends an include element
Syntax:	SSIEndTag tag
Default:	SSIEndTag "-->"
Context:	server config, virtual host
Status:	Base
Module:	mod_include
Compatibility:	Available in version 2.0.30 and later.

This directive changes the string that [MOD_INCLUDE](#) looks for to mark the end of an include element.

Example
SSIEndTag "%>"

See also

- [SSISTARTTAG](#)

SSIErrorMsg Directive

Description:	Error message displayed when there is an SSI error
Syntax:	SSIErrorMsg message
Default:	SSIErrorMsg "[an error occurred while processing this directive]"
Context:	server config, virtual host, directory, .htaccess
Override:	All
Status:	Base
Module:	mod_include
Compatibility:	Available in version 2.0.30 and later.

The `SSIErrorMsg` directive changes the error message displayed when `MOD_INCLUDE` encounters an error. For production servers you may consider changing the default error message to `<!-- Error -->` so that the message is not presented to the user.

This directive has the same effect as the `<!--#config errmsg=message -->` element.

Example

```
SSIErrorMsg "<!-- Error -->"
```

SSIStartTag Directive

Description:	String that starts an include element
Syntax:	<code>SSIStartTag tag</code>
Default:	<code>SSIStartTag "<!--#"</code>
Context:	server config, virtual host
Status:	Base
Module:	<code>mod_include</code>
Compatibility:	Available in version 2.0.30 and later.

This directive changes the string that `MOD_INCLUDE` looks for to mark an include element to process.

You may want to use this option if you have 2 servers parsing the output of a file each processing different commands (possibly at different times).

Example

```
SSIStartTag "<%"
SSIEndTag "%>"
```

The example given above, which also specifies a matching `SSIENDTAG`, will allow you to use SSI directives as shown in the example below:

SSI directives with alternate start and end tags

```
<%printenv %>
```

See also

- [SSIENDTAG](#)

SSITimeFormat Directive

Description:	Configures the format in which date strings are displayed
Syntax:	<code>SSITimeFormat formatstring</code>
Default:	<code>SSITimeFormat "%A, %d-%b-%Y %H:%M:%S %Z"</code>
Context:	server config, virtual host, directory, <code>.htaccess</code>
Override:	All
Status:	Base
Module:	<code>mod_include</code>
Compatibility:	Available in version 2.0.30 and later.

This directive changes the format in which date strings are displayed when echoing `DATE` environment variables. The `formatstring` is as in `strftime(3)` from the C standard library.

This directive has the same effect as the `<!--#config timefmt=formatstring -->` element.

Example

```
SSITimeFormat "%R, %B %d, %Y"
```

The above directive would cause times to be displayed in the format "22:26, June 14, 2002".

SSIUndefinedEcho Directive

Description:	String displayed when an unset variable is echoed
Syntax:	SSIUndefinedEcho string
Default:	SSIUndefinedEcho "(none)"
Context:	server config, virtual host
Status:	Base
Module:	mod_include
Compatibility:	Available in version 2.0.34 and later.

This directive changes the string that [MOD_INCLUDE](#) displays when a variable is not set and "echoed".

Example

```
SSIUndefinedEcho "<!-- undef -->"
```

XBitHack Directive

Description:	Parse SSI directives in files with the execute bit set
Syntax:	XBitHack on off full
Default:	XBitHack off
Context:	server config, virtual host, directory, .htaccess
Override:	Options
Status:	Base
Module:	mod_include

The [XBITHACK](#) directive controls the parsing of ordinary html documents. This directive only affects files associated with the MIME type `text/html`. [XBITHACK](#) can take on the following values:

off No special treatment of executable files.

on Any `text/html` file that has the user-execute bit set will be treated as a server-parsed html document.

full As for `on` but also test the group-execute bit. If it is set, then set the `Last-modified` date of the returned file to be the last modified time of the file. If it is not set, then no last-modified date is sent. Setting this bit allows clients and proxies to cache the result of the request.

 **Note**

You would not want to use the full option, unless you assure the group-execute bit is unset for every SSI script which might `#include` a CGI or otherwise produces different output on each hit (or could potentially change on subsequent requests).

10.34 Apache Module mod_info

Description:	Provides a comprehensive overview of the server configuration
Status:	Extension
ModuleIdentifier:	info_module
SourceFile:	mod_info.c

Summary

To configure [MOD_INFO](#), add the following to your `httpd.conf` file.

```
<Location /server-info>
    SetHandler server-info
</Location>
```

You may wish to use [MOD_ACCESS](#) inside the `<LOCATION>` directive to limit access to your server configuration information:

```
<Location /server-info>
    SetHandler server-info
    Order deny,allow
    Deny from all
    Allow from yourcompany.com
</Location>
```

Once configured, the server information is obtained by accessing `http://your.host.dom/server-info`

⇒ Note that the configuration files are read by the module at run-time, and therefore the display may *not* reflect the running server's active configuration if the files have been changed since the server was last reloaded. Also, the configuration files must be readable by the user as which the server is running (see the [USER](#) directive), or else the directive settings will not be listed. It should also be noted that if [MOD_INFO](#) is compiled into the server, its handler capability is available in *all* configuration files, including per-directory files (*e.g.*, `.htaccess`). This may have security-related ramifications for your site. In particular, this module can leak sensitive information from the configuration directives of other Apache modules such as system paths, usernames/passwords, database names, etc. Due to the way this module works there is no way to block information from it. Therefore, this module should **only** be used in a controlled environment and always with caution.

Directives

- `AddModuleInfo`

AddModuleInfo Directive

Description:	Adds additional information to the module information displayed by the server-info handler
Syntax:	<code>AddModuleInfo module-name string</code>
Context:	server config, virtual host
Status:	Extension
Module:	mod_info
Compatibility:	Apache 1.3 and above

This allows the content of string to be shown as HTML interpreted, **Additional Information** for the module module-name. Example:

```
AddModuleInfo mod_auth.c 'See <a \
    href="http://www.apache.org/docs/2.0/mod/mod_auth.html">\
    http://www.apache.org/docs/2.0/mod/mod_auth.html</a>'
```

10.35 Apache Module mod_isapi

Description:	ISAPI Extensions within Apache for Windows
Status:	Base
ModuleIdentifier:	isapi_module
SourceFile:	mod_isapi.c
Compatibility:	Win32 only

Summary

This module implements the Internet Server extension API. It allows Internet Server extensions (*e.g.* ISAPI .dll modules) to be served by Apache for Windows, subject to the noted restrictions.

ISAPI extension modules (.dll files) are written by third parties. The Apache Group does not author these modules, so we provide no support for them. Please contact the ISAPI's author directly if you are experiencing problems running their ISAPI extension. **Please *do not* post such problems to Apache's lists or bug reporting pages.**

Directives

- ISAPIAppendLogToErrors
- ISAPIAppendLogToQuery
- ISAPICacheFile
- ISAPIFakeAsync
- ISAPILogNotSupported
- ISAPIReadAheadBuffer

Usage

In the server configuration file, use the [ADDHANDLER](#) directive to associate ISAPI files with the `isapi-handler` handler, and map it to them with their file extensions. To enable any .dll file to be processed as an ISAPI extension, edit the `httpd.conf` file and add the following line:

```
AddHandler isapi-handler .dll
```

⇒ In versions of the Apache server prior to 2.0.37, use `isapi-isa` instead of `isapi-handler`. The new handler name is not available prior to version 2.0.37. For compatibility, configurations may continue using `isapi-isa` through all versions of Apache prior to 2.3.0.

There is no capability within the Apache server to leave a requested module loaded. However, you may preload and keep a specific module loaded by using the following syntax in your `httpd.conf`:

```
ISAPICacheFile c:/WebWork/Scripts/ISAPI/mytest.dll
```

Whether or not you have preloaded an ISAPI extension, all ISAPI extensions are governed by the same permissions and restrictions as CGI scripts. That is, [OPTIONS](#) `ExecCGI` must be set for the directory that contains the ISAPI .dll file.

Review the Additional Notes and the Programmer's Journal for additional details and clarification of the specific ISAPI support offered by [MOD_ISAPI](#).

Additional Notes

Apache's ISAPI implementation conforms to all of the ISAPI 2.0 specification, except for some "Microsoft-specific" extensions dealing with asynchronous I/O. Apache's I/O model does not allow asynchronous reading and writing in a manner that the ISAPI could access. If an ISA tries to access unsupported features, including async I/O, a message is placed in the error log to help with debugging. Since these messages can become a flood, the directive `ISAPILogNotSupported Off` exists to quiet this noise.

Some servers, like Microsoft IIS, load the ISAPI extension into the server and keep it loaded until memory usage is too high, or unless configuration options are specified. Apache currently loads and unloads the ISAPI extension each time it is requested, unless the `ISAPICACHEFILE` directive is specified. This is inefficient, but Apache's memory model makes this the most effective method. Many ISAPI modules are subtly incompatible with the Apache server, and unloading these modules helps to ensure the stability of the server.

Also, remember that while Apache supports ISAPI Extensions, it **does not support ISAPI Filters**. Support for filters may be added at a later date, but no support is planned at this time.

Programmer's Journal

If you are programming Apache 2.0 `MOD_ISAPI` modules, you must limit your calls to `ServerSupportFunction` to the following directives:

HSE_REQ_SEND_URL_REDIRECT_RESP Redirect the user to another location.
This must be a fully qualified URL (e.g. `http://server/location`).

HSE_REQ_SEND_URL Redirect the user to another location.
This cannot be a fully qualified URL, you are not allowed to pass the protocol or a server name (e.g. `simply/location`).
This redirection is handled by the server, not the browser.



Warning

In their recent documentation, Microsoft appears to have abandoned the distinction between the two `HSE_REQ_SEND_URL` functions. Apache continues to treat them as two distinct functions with different requirements and behaviors.

HSE_REQ_SEND_RESPONSE_HEADER Apache accepts a response body following the header if it follows the blank line (two consecutive newlines) in the headers string argument. This body cannot contain NULLs, since the headers argument is NULL terminated.

HSE_REQ_DONE_WITH_SESSION Apache considers this a no-op, since the session will be finished when the ISAPI returns from processing.

HSE_REQ_MAP_URL_TO_PATH Apache will translate a virtual name to a physical name.

HSE_APPEND_LOG_PARAMETER This logged message may be captured in any of the following logs:

- in the `\%{isapi-parameter}n\` component in a `CUSTOMLOG` directive
- in the `%q` log component with the `ISAPIAPPENDLOGTOQUERY On` directive
- in the error log with the `ISAPIAPPENDLOGTOERRORS On` directive

The first option, the `%{isapi-parameter}n` component, is always available and preferred.

HSE_REQ_IS_KEEP_CONN Will return the negotiated Keep-Alive status.

HSE_REQ_SEND_RESPONSE_HEADER_EX Will behave as documented, although the `fKeepConn` flag is ignored.

HSE_REQ_IS_CONNECTED Will report false if the request has been aborted.

Apache returns FALSE to any unsupported call to `ServerSupportFunction`, and sets the `GetLastError` value to `ERROR_INVALID_PARAMETER`.

`ReadClient` retrieves the request body exceeding the initial buffer (defined by `ISAPIREADAHEADBUFFER`). Based on the `ISAPIREADAHEADBUFFER` setting (number of bytes to buffer prior to calling the ISAPI handler) shorter requests are sent complete to the extension when it is invoked. If the request is longer, the ISAPI extension must use `ReadClient` to retrieve the remaining request body.

`WriteClient` is supported, but only with the `HSE_IO_SYNC` flag or no option flag (value of 0). Any other `WriteClient` request will be rejected with a return value of FALSE, and a `GetLastError` value of `ERROR_INVALID_PARAMETER`.

`GetServerVariable` is supported, although extended server variables do not exist (as defined by other servers.) All the usual Apache CGI environment variables are available from `GetServerVariable`, as well as the `ALL_HTTP` and `ALL_RAW` values.

Apache 2.0 `MOD_ISAPI` supports additional features introduced in later versions of the ISAPI specification, as well as limited emulation of async I/O and the `TransmitFile` semantics. Apache also supports preloading ISAPI .dlls for performance, neither of which were not available under Apache 1.3 `mod_isapi`.

ISAPIAppendLogToErrors Directive

Description:	Record <code>HSE_APPEND_LOG_PARAMETER</code> requests from ISAPI extensions to the error log
Syntax:	<code>ISAPIAppendLogToErrors on off</code>
Default:	<code>ISAPIAppendLogToErrors off</code>
Context:	server config, virtual host, directory, .htaccess
Override:	FileInfo
Status:	Base
Module:	<code>mod_isapi</code>

Record `HSE_APPEND_LOG_PARAMETER` requests from ISAPI extensions to the server error log.

ISAPIAppendLogToQuery Directive

Description:	Record <code>HSE_APPEND_LOG_PARAMETER</code> requests from ISAPI extensions to the query field
Syntax:	<code>ISAPIAppendLogToQuery on off</code>
Default:	<code>ISAPIAppendLogToQuery on</code>
Context:	server config, virtual host, directory, .htaccess
Override:	FileInfo
Status:	Base
Module:	<code>mod_isapi</code>

Record `HSE_APPEND_LOG_PARAMETER` requests from ISAPI extensions to the query field (appended to the `CUSTOMLOG %q` component).

ISAPICacheFile Directive

Description:	ISAPI .dll files to be loaded at startup
Syntax:	<code>ISAPICacheFile file-path [file-path] ...</code>
Context:	server config, virtual host
Status:	Base
Module:	<code>mod_isapi</code>

Specifies a space-separated list of file names to be loaded when the Apache server is launched, and remain loaded until the server is shut down. This directive may be repeated for every ISAPI .dll file desired. The full path name of each file should be specified. If the path name is not absolute, it will be treated relative to [SERVERROOT](#).

ISAPIFakeAsync Directive

Description:	Fake asynchronous support for ISAPI callbacks
Syntax:	ISAPIFakeAsync on off
Default:	ISAPIFakeAsync off
Context:	server config, virtual host, directory, .htaccess
Override:	FileInfo
Status:	Base
Module:	mod_isapi

While set to on, asynchronous support for ISAPI callbacks is simulated.

ISAPILogNotSupported Directive

Description:	Log unsupported feature requests from ISAPI extensions
Syntax:	ISAPILogNotSupported on off
Default:	ISAPILogNotSupported off
Context:	server config, virtual host, directory, .htaccess
Override:	FileInfo
Status:	Base
Module:	mod_isapi

Logs all requests for unsupported features from ISAPI extensions in the server error log. This may help administrators to track down problems. Once set to on and all desired ISAPI modules are functioning, it should be set back to off.

ISAPIReadAheadBuffer Directive

Description:	Size of the Read Ahead Buffer sent to ISAPI extensions
Syntax:	ISAPIReadAheadBuffer size
Default:	ISAPIReadAheadBuffer 49152
Context:	server config, virtual host, directory, .htaccess
Override:	FileInfo
Status:	Base
Module:	mod_isapi

Defines the maximum size of the Read Ahead Buffer sent to ISAPI extensions when they are initially invoked. All remaining data must be retrieved using the `ReadClient` callback; some ISAPI extensions may not support the `ReadClient` function. Refer questions to the ISAPI extension's author.

10.36 Apache Module mod_ldap

Description:	LDAP connection pooling and result caching services for use by other LDAP modules
Status:	Experimental
ModuleIdentifier:	ldap_module
SourceFile:	util_ldap.c
Compatibility:	Available in version 2.0.41 and later

Summary

This module was created to improve the performance of websites relying on backend connections to LDAP servers. In addition to the functions provided by the standard LDAP libraries, this module adds an LDAP connection pool and an LDAP shared memory cache.

To enable this module, LDAP support must be compiled into apr-util. This is achieved by adding the `--with-ldap` flag to the configure script when building Apache.

SSL support requires that `MOD_LDAP` be linked with one of the following LDAP SDKs: OpenLDAP SDK¹⁹ (both 1.x and 2.x), Novell LDAP SDK²⁰ or the iPlanet(Netscape)²¹ SDK.

Directives

- LDAPCacheEntries
- LDAPCacheTTL
- LDAPConnectionTimeout
- LDAPOpCacheEntries
- LDAPOpCacheTTL
- LDAPSharedCacheFile
- LDAPSharedCacheSize
- LDAPTrustedCA
- LDAPTrustedCAType

Example Configuration

The following is an example configuration that uses `MOD_LDAP` to increase the performance of HTTP Basic authentication provided by `MOD_AUTH_LDAP`.

¹⁹<http://www.openldap.org/>

²⁰<http://developer.novell.com/ndk/cldap.htm>

²¹<http://www.ipplanet.com/downloads/developer/>

```

# Enable the LDAP connection pool and shared
# memory cache. Enable the LDAP cache status
# handler. Requires that mod_ldap and mod_auth_ldap
# be loaded. Change the "yourdomain.example.com" to
# match your domain.
LDAPSharedCacheSize 200000
LDAPCacheEntries 1024
LDAPCacheTTL 600
LDAPOpCacheEntries 1024
LDAPOpCacheTTL 600
<Location /ldap-status>
    SetHandler ldap-status
    Order deny,allow
    Deny from all
    Allow from yourdomain.example.com
    AuthLDAPEnabled on
    AuthLDAPURL ldap://127.0.0.1/dc=example,dc=com?uid?one
    AuthLDAPAuthoritative on
    Require valid-user
</Location>

```

LDAP Connection Pool

LDAP connections are pooled from request to request. This allows the LDAP server to remain connected and bound ready for the next request, without the need to unbind/connect/rebind. The performance advantages are similar to the effect of HTTP keepalives.

On a busy server it is possible that many requests will try and access the same LDAP server connection simultaneously. Where an LDAP connection is in use, Apache will create a new connection alongside the original one. This ensures that the connection pool does not become a bottleneck.

There is no need to manually enable connection pooling in the Apache configuration. Any module using this module for access to LDAP services will share the connection pool.

LDAP Cache

For improved performance, [MOD_LDAP](#) uses an aggressive caching strategy to minimize the number of times that the LDAP server must be contacted. Caching can easily double or triple the throughput of Apache when it is serving pages protected with `mod_auth_ldap`. In addition, the load on the LDAP server will be significantly decreased.

[MOD_LDAP](#) supports two types of LDAP caching during the search/bind phase with a *search/bind cache* and during the compare phase with two *operation caches*. Each LDAP URL that is used by the server has its own set of these three caches.

The Search/Bind Cache

The process of doing a search and then a bind is the most time-consuming aspect of LDAP operation, especially if the directory is large. The search/bind cache is used to cache all searches that resulted in successful binds. Negative results (*i.e.*, unsuccessful searches, or searches that did not result in a successful bind) are not cached. The rationale behind this decision is that connections with invalid credentials are only a tiny percentage of the total number of connections, so by not caching invalid credentials, the size of the cache is reduced.

[MOD_LDAP](#) stores the username, the DN retrieved, the password used to bind, and the time of the bind in the cache. Whenever a new connection is initiated with the same username, [MOD_LDAP](#) compares the password of the new

connection with the password in the cache. If the passwords match, and if the cached entry is not too old, [MOD_LDAP](#) bypasses the search/bind phase.

The search and bind cache is controlled with the [LDAPCACHEENTRIES](#) and [LDAPCACHETTTL](#) directives.

Operation Caches

During attribute and distinguished name comparison functions, [MOD_LDAP](#) uses two operation caches to cache the compare operations. The first compare cache is used to cache the results of compares done to test for LDAP group membership. The second compare cache is used to cache the results of comparisons done between distinguished names.

The behavior of both of these caches is controlled with the [LDAPOPCACHEENTRIES](#) and [LDAPOPCACHETTTL](#) directives.

Monitoring the Cache

[MOD_LDAP](#) has a content handler that allows administrators to monitor the cache performance. The name of the content handler is `ldap-status`, so the following directives could be used to access the [MOD_LDAP](#) cache information:

```
<Location /server/cache-info>
    SetHandler ldap-status
</Location>
```

By fetching the URL `http://servername/cache-info`, the administrator can get a status report of every cache that is used by [MOD_LDAP](#) cache. Note that if Apache does not support shared memory, then each httpd instance has its own cache, so reloading the URL will result in different information each time, depending on which httpd instance processes the request.

Using SSL

The ability to create an SSL connections to an LDAP server is defined by the directives [LDAPTRUSTEDCA](#) and [LDAPTRUSTEDCATYPE](#). These directives specify the certificate file or database and the certificate type. Whenever the LDAP url includes `ldaps://`, [MOD_LDAP](#) will establish a secure connection to the LDAP server.

```
# Establish an SSL LDAP connection. Requires that
# mod_ldap and mod_auth_ldap be loaded. Change the
# "yourdomain.example.com" to match your domain.
LDAPTrustedCA /certs/certfile.der
LDAPTrustedCAType DER.FILE
<Location /ldap-status>
    SetHandler ldap-status
    Order deny,allow
    Deny from all
    Allow from yourdomain.example.com
    AuthLDAPEnabled on
    AuthLDAPURL ldaps://127.0.0.1/dc=example,dc=com?uid?one
    AuthLDAPAuthoritative on
    Require valid-user
</Location>
```

If `MOD_LDAP` is linked against the Netscape/iPlanet LDAP SDK, it will not talk to any SSL server unless that server has a certificate signed by a known Certificate Authority. As part of the configuration `MOD_LDAP` needs to be told where it can find a database containing the known CAs. This database is in the same format as Netscape Communicator's `cert7.db` database. The easiest way to get this file is to start up a fresh copy of Netscape, and grab the resulting `$HOME/.netscape/cert7.db` file.

LDAPCacheEntries Directive

Description:	Maximum number of entries in the primary LDAP cache
Syntax:	<code>LDAPCacheEntries number</code>
Default:	<code>LDAPCacheEntries 1024</code>
Context:	server config
Status:	Experimental
Module:	<code>mod_ldap</code>

Specifies the maximum size of the primary LDAP cache. This cache contains successful search/binds. Set it to 0 to turn off search/bind caching. The default size is 1024 cached searches.

LDAPCacheTTL Directive

Description:	Time that cached items remain valid
Syntax:	<code>LDAPCacheTTL seconds</code>
Default:	<code>LDAPCacheTTL 600</code>
Context:	server config
Status:	Experimental
Module:	<code>mod_ldap</code>

Specifies the time (in seconds) that an item in the search/bind cache remains valid. The default is 600 seconds (10 minutes).

LDAPConnectionTimeout Directive

Description:	Specifies the socket connection timeout in seconds
Syntax:	<code>LDAPConnectionTimeout seconds</code>
Context:	server config
Status:	Experimental
Module:	<code>mod_ldap</code>

Specifies the timeout value (in seconds) in which the module will attempt to connect to the LDAP server. If a connection is not successful with the timeout period, either an error will be returned or the module will attempt to connect to a secondary LDAP server if one is specified. The default is 10 seconds.

LDAPOpCacheEntries Directive

Description:	Number of entries used to cache LDAP compare operations
Syntax:	<code>LDAPOpCacheEntries number</code>
Default:	<code>LDAPOpCacheEntries 1024</code>
Context:	server config
Status:	Experimental
Module:	<code>mod_ldap</code>

This specifies the number of entries `MOD_LDAP` will use to cache LDAP compare operations. The default is 1024 entries. Setting it to 0 disables operation caching.

LDAPOpCacheTTL Directive

Description:	Time that entries in the operation cache remain valid
Syntax:	LDAPOpCacheTTL seconds
Default:	LDAPOpCacheTTL 600
Context:	server config
Status:	Experimental
Module:	mod_ldap

Specifies the time (in seconds) that entries in the operation cache remain valid. The default is 600 seconds.

LDAPSharedCacheFile Directive

Description:	Sets the shared memory cache file
Syntax:	LDAPSharedCacheFile directory-path/filename
Context:	server config
Status:	Experimental
Module:	mod_ldap

Specifies the directory path and file name of the shared memory cache file. If not set, anonymous shared memory will be used if the platform supports it.

LDAPSharedCacheSize Directive

Description:	Size in bytes of the shared-memory cache
Syntax:	LDAPSharedCacheSize bytes
Default:	LDAPSharedCacheSize 102400
Context:	server config
Status:	Experimental
Module:	mod_ldap

Specifies the number of bytes to allocate for the shared memory cache. The default is 100kb. If set to 0, shared memory caching will not be used.

LDAPTrustedCA Directive

Description:	Sets the file containing the trusted Certificate Authority certificate or database
Syntax:	LDAPTrustedCA directory-path/filename
Context:	server config
Status:	Experimental
Module:	mod_ldap

It specifies the directory path and file name of the trusted CA [MOD_LDAP](#) should use when establishing an SSL connection to an LDAP server. If using the Netscape/iPlanet Directory SDK, the file name should be `cert7.db`.

LDAPTrustedCAType Directive

Description:	Specifies the type of the Certificate Authority file
Syntax:	LDAPTrustedCAType type
Context:	server config
Status:	Experimental
Module:	mod_ldap

The following types are supported:

DER_FILE - file in binary DER format

BASE64_FILE - file in Base64 format

CERT7_DB_PATH - Netscape certificate database file ")

10.37 Apache Module mod_log_config

Description:	Logging of the requests made to the server
Status:	Base
ModuleIdentifier:	log_config_module
SourceFile:	mod_log_config.c

Summary

This module provides for flexible logging of client requests. Logs are written in a customizable format, and may be written directly to a file, or to an external program. Conditional logging is provided so that individual requests may be included or excluded from the logs based on characteristics of the request.

Three directives are provided by this module: [TRANSFERLOG](#) to create a log file, [LOGFORMAT](#) to set a custom format, and [CUSTOMLOG](#) to define a log file and format in one step. The [TRANSFERLOG](#) and [CUSTOMLOG](#) directives can be used multiple times in each server to cause each request to be logged to multiple files.

Directives

- BufferedLogs
- CookieLog
- CustomLog
- LogFormat
- TransferLog

See also

- Apache Log Files (p. 29)

Custom Log Formats

The format argument to the [LOGFORMAT](#) and [CUSTOMLOG](#) directives is a string. This string is used to log each request to the log file. It can contain literal characters copied into the log files and the C-style control characters "`\n`" and "`\t`" to represent new-lines and tabs. Literal quotes and back-slashes should be escaped with back-slashes.

The characteristics of the request itself are logged by placing "`%`" directives in the format string, which are replaced in the log file by the values as follows:

FormatString	Description
<code>%%</code>	The percent sign (<i>Apache 2.0.44 and later</i>)
<code>%. . . a</code>	Remote IP-address
<code>%. . . A</code>	Local IP-address
<code>%. . . B</code>	Size of response in bytes, excluding HTTP headers.
<code>%. . . b</code>	Size of response in bytes, excluding HTTP headers. In CLF format, <i>i.e.</i> a '-' rather than a 0 when no bytes are sent.
<code>%. . . {Foobar}C</code>	The contents of cookie Foobar in the request sent to the server.
<code>%. . . D</code>	The time taken to serve the request, in microseconds.
<code>%. . . {FOOBAR}e</code>	The contents of the environment variable FOOBAR
<code>%. . . f</code>	Filename
<code>%. . . h</code>	Remote host
<code>%. . . H</code>	The request protocol

<code>%...{Foobar}i</code>	The contents of <code>Foobar</code> : header line(s) in the request sent to the server.
<code>%...l</code>	Remote logname (from <code>identd</code> , if supplied). This will return a dash unless <code>IDENTITYCHECK</code> is set On.
<code>%...m</code>	The request method
<code>%...{Foobar}n</code>	The contents of note <code>Foobar</code> from another module.
<code>%...{Foobar}o</code>	The contents of <code>Foobar</code> : header line(s) in the reply.
<code>%...p</code>	The canonical port of the server serving the request
<code>%...P</code>	The process ID of the child that serviced the request.
<code>%...{format}P</code>	The process ID or thread id of the child that serviced the request. Valid formats are <code>pid</code> and <code>tid</code> . (<i>Apache 2.0.46 and later</i>)
<code>%...q</code>	The query string (prepended with a <code>?</code> if a query string exists, otherwise an empty string)
<code>%...r</code>	First line of request
<code>%...s</code>	Status. For requests that got internally redirected, this is the status of the *original* request — <code>%...>s</code> for the last.
<code>%...t</code>	Time the request was received (standard english format)
<code>%...{format}t</code>	The time, in the form given by <code>format</code> , which should be in <code>strftime(3)</code> format. (potentially localized)
<code>%...T</code>	The time taken to serve the request, in seconds.
<code>%...u</code>	Remote user (from <code>auth</code> ; may be bogus if return status (<code>%s</code>) is 401)
<code>%...U</code>	The URL path requested, not including any query string.
<code>%...v</code>	The canonical <code>SERVERNAME</code> of the server serving the request.
<code>%...V</code>	The server name according to the <code>USECANONICALNAME</code> setting.
<code>%...X</code>	Connection status when response is completed: <div style="border: 1px solid black; padding: 5px; margin: 5px 0;"> <code>X =</code> connection aborted before the response completed. <code>+</code> connection may be kept alive after the response is sent. <code>-</code> connection will be closed after the response is sent. </div> (This directive was <code>%...c</code> in late versions of Apache 1.3, but this conflicted with the historical <code>ssl %...{var}c</code> syntax.)
<code>%...I</code>	Bytes received, including request and headers, cannot be zero. You need to enable <code>MOD_LOGIO</code> to use this.
<code>%...O</code>	Bytes sent, including headers, cannot be zero. You need to enable <code>MOD_LOGIO</code> to use this.

The "... " can be nothing at all (e.g., "`%h %u %r %s %b`"), or it can indicate conditions for inclusion of the item (which will cause it to be replaced with "-" if the condition is not met). The forms of condition are a list of HTTP status codes, which may or may not be preceded by "!". Thus, "`%400,501{User-agent}i`" logs `User-agent:` on 400 errors and 501 errors (Bad Request, Not Implemented) only; "`%!200,304,302{Referer}i`" logs `Referer:` on all requests which did *not* return some sort of normal status.

The modifiers "<" and ">" can be used for requests that have been internally redirected to choose whether the original or final (respectively) request should be consulted. By default, the % directives `%s`, `%U`, `%T`, `%D`, and `%r` look at the original request while all others look at the final request. So for example, `%>s` can be used to record the final status of the request and `%<u` can be used to record the original authenticated user on a request that is internally redirected to an unauthenticated resource.

Note that in `httpd` 2.0 versions prior to 2.0.46, no escaping was performed on the strings from `%...r`, `%...i` and `%...o`. This was mainly to comply with the requirements of the Common Log Format. This implied that clients could insert control characters into the log, so you had to be quite careful when dealing with raw log files.

For security reasons, starting with 2.0.46, non-printable and other special characters are escaped mostly by using `\xhh` sequences, where `hh` stands for the hexadecimal representation of the raw byte. Exceptions from this rule are "`\`" and `\` which are escaped by prepending a backslash, and all whitespace characters which are written in their C-style notation (`\n`, `\t` etc).

Note that in `httpd` 2.0, unlike 1.3, the `%b` and `%B` format strings do not represent the number of bytes sent to the client, but simply the size in bytes of the HTTP response (which will differ, for instance, if the connection is aborted, or if SSL is used). The `%O` format provided by `MOD_LOGIO` will log the actual number of bytes sent over the network.

Some commonly used log format strings are:

Common Log Format (CLF) "%h %l %u %t \"%r\" %>s %b"

Common Log Format with Virtual Host "%v %h %l %u %t \"%r\" %>s %b"

NCSA extended/combined log format "%h %l %u %t \"%r\" %>s %b \"%{Referer}i\" \"%{User-agent}i\""

Referer log format "%{Referer}i -> %U"

Agent (Browser) log format "%{User-agent}i"

Note that the canonical [SERVERNAME](#) and [LISTEN](#) of the server serving the request are used for %v and %p respectively. This happens regardless of the [USECANONICALNAME](#) setting because otherwise log analysis programs would have to duplicate the entire vhost matching algorithm in order to decide what host really served the request.

Security Considerations

See the security tips (p. 40) document for details on why your security could be compromised if the directory where logfiles are stored is writable by anyone other than the user that starts the server.

BufferedLogs Directive

Description:	Buffer log entries in memory before writing to disk
Syntax:	BufferedLogs On Off
Default:	BufferedLogs Off
Context:	server config
Status:	Base
Module:	mod_log_config
Compatibility:	Available in versions 2.0.41 and later.

The [BUFFEREDLOGS](#) directive causes [MOD_LOG_CONFIG](#) to store several log entries in memory and write them together to disk, rather than writing them after each request. On some systems, this may result in more efficient disk access and hence higher performance. It may be set only once for the entire server; it cannot be configured per virtual-host.

⇒ This directive is experimental and should be used with caution.

CookieLog Directive

Description:	Sets filename for the logging of cookies
Syntax:	CookieLog filename
Context:	server config, virtual host
Status:	Base
Module:	mod_log_config
Compatibility:	This directive is deprecated.

The [COOKIELOG](#) directive sets the filename for logging of cookies. The filename is relative to the [SERVERROOT](#). This directive is included only for compatibility with `mod_cookies`, and is deprecated.

CustomLog Directive

Description:	Sets filename and format of log file
Syntax:	CustomLog file pipe format nickname [env=[!]environment-variable]
Context:	server config, virtual host
Status:	Base
Module:	mod_log_config

The **CUSTOMLOG** directive is used to log requests to the server. A log format is specified, and the logging can optionally be made conditional on request characteristics using environment variables.

The first argument, which specifies the location to which the logs will be written, can take one of the following two types of values:

file A filename, relative to the **SERVERROOT**.

pipe The pipe character "|", followed by the path to a program to receive the log information on its standard input.



Security:

If a program is used, then it will be run as the user who started httpd. This will be root if the server was started by root; be sure that the program is secure.



Note

When entering a file path on non-Unix platforms, care should be taken to make sure that only forward slashed are used even though the platform may allow the use of back slashes. In general it is a good idea to always use forward slashes throughout the configuration files.

The second argument specifies what will be written to the log file. It can specify either a nickname defined by a previous **LOGFORMAT** directive, or it can be an explicit format string as described in the log formats section.

For example, the following two sets of directives have exactly the same effect:

```
# CustomLog with format nickname
LogFormat "%h %l %u %t \"%r\" %>s %b" common
CustomLog logs/access.log common
# CustomLog with explicit format string
CustomLog logs/access.log "%h %l %u %t \"%r\" %>s %b"
```

The third argument is optional and controls whether or not to log a particular request based on the presence or absence of a particular variable in the server environment. If the specified environment variable (p. 60) is set for the request (or is not set, in the case of a 'env=!name' clause), then the request will be logged.

Environment variables can be set on a per-request basis using the **MOD_SETENVIF** and/or **MOD_REWRITE** modules. For example, if you want to record requests for all GIF images on your server in a separate logfile but not in your main log, you can use:

```
SetEnvIf Request_URI \.gif$ gif-image
CustomLog gif-requests.log common env=gif-image
CustomLog nongif-requests.log common env=!gif-image
```

Or, to reproduce the behavior of the old **RefererIgnore** directive, you might use the following:

```
SetEnvIf Referer example\.com localreferer
CustomLog referer.log referer env=!localreferer
```

LogFormat Directive

Description:	Describes a format for use in a log file
Syntax:	LogFormat format nickname [nickname]
Default:	LogFormat "%h %l %u %t \"%r\" %>s %b"
Context:	server config, virtual host
Status:	Base
Module:	mod_log_config

This directive specifies the format of the access log file.

The **LOGFORMAT** directive can take one of two forms. In the first form, where only one argument is specified, this directive sets the log format which will be used by logs specified in subsequent **TRANSFERLOG** directives. The single argument can specify an explicit format as discussed in the custom log formats section above. Alternatively, it can use a nickname to refer to a log format defined in a previous **LOGFORMAT** directive as described below.

The second form of the **LOGFORMAT** directive associates an explicit format with a nickname. This nickname can then be used in subsequent **LOGFORMAT** or **CUSTOMLOG** directives rather than repeating the entire format string. A **LOGFORMAT** directive that defines a nickname **does nothing else** – that is, it *only* defines the nickname, it doesn't actually apply the format and make it the default. Therefore, it will not affect subsequent **TRANSFERLOG** directives. In addition, **LOGFORMAT** cannot use one nickname to define another nickname. Note that the nickname should not contain percent signs (%).

Example

```
LogFormat "%v %h %l %u %t \"%r\" %>s %b" vhost_common
```

TransferLog Directive

Description:	Specify location of a log file
Syntax:	TransferLog file pipe
Context:	server config, virtual host
Status:	Base
Module:	mod_log_config

This directive has exactly the same arguments and effect as the **CUSTOMLOG** directive, with the exception that it does not allow the log format to be specified explicitly or for conditional logging of requests. Instead, the log format is determined by the most recently specified **LOGFORMAT** directive which does not define a nickname. Common Log Format is used if no other format has been specified.

Example

```
LogFormat "%h %l %u %t \"%r\" %>s %b \"%{Referer}i\" \"%{User-agent}i\" \"
TransferLog logs/access_log
```

10.38 Apache Module `mod_log_forensic`

Description:	Forensic Logging of the requests made to the server
Status:	Extension
ModuleIdentifier:	<code>log_forensic_module</code>
SourceFile:	<code>mod_log_forensic.c</code>
Compatibility:	Available in version 2.0.50 and later

Summary

This module provides for forensic logging of client requests. Logging is done before and after processing a request, so the forensic log contains two log lines for each request. The forensic logger is very strict, which means:

- The format is fixed. You cannot modify the logging format at runtime.
- If it cannot write its data, the child process exits immediately and may dump core (depending on your `CORE-DUMPDIRECTORY` configuration).

The `check_forensic` script, which can be found in the distribution's support directory, may be helpful in evaluating the forensic log output.



This module was backported from version 2.1 which uses a more powerful APR version in order to generate the forensic IDs. If you want to run `MOD_LOG_FORENSIC` in version 2.0, you need to include `MOD_UNIQUE_ID` as well.

Directives

- `ForensicLog`

See also

- Apache Log Files (p. 29)
- `MOD_LOG_CONFIG`

Forensic Log Format

Each request is logged two times. The first time is *before* it's processed further (that is, after receiving the headers). The second log entry is written *after* the request processing at the same time where normal logging occurs.

In order to identify each request, a unique request ID is assigned. This forensic ID can be cross logged in the normal transfer log using the `%{forensic-id}n` format string. If you're using `MOD_UNIQUE_ID`, its generated ID will be used.

The first line logs the forensic ID, the request line and all received headers, separated by pipe characters (`|`). A sample line looks like the following (all on one line):

```
+yQtJf8CoAB4AAFNBIEAAAAA|GET /manual/de/images/down.gif
HTTP/1.1|Host:localhost%3a8080|User-Agent:Mozilla/5.0 (X11; U; Linux
i686; en-US; rv%3a1.6) Gecko/20040216 Firefox/0.8|Accept:image/png,
etc...
```

The plus character at the beginning indicates that this is the first log line of this request. The second line just contains a minus character and the ID again:

```
-yQtJf8CoAB4AAFNBIEAAAAA
```

The `check_forensic` script takes as its argument the name of the logfile. It looks for those +/- ID pairs and complains if a request was not completed.

Security Considerations

See the security tips (p. 40) document for details on why your security could be compromised if the directory where logfiles are stored is writable by anyone other than the user that starts the server.

ForensicLog Directive

Description:	Sets filename of the forensic log
Syntax:	<code>ForensicLog filename pipe</code>
Context:	server config, virtual host
Status:	Extension
Module:	<code>mod_log_forensic</code>

The **FORENSICLOG** directive is used to log requests to the server for forensic analysis. Each log entry is assigned a unique ID which can be associated with the request using the normal **CUSTOMLOG** directive. **MOD_LOG_FORENSIC** takes the unique ID from **MOD_UNIQUE_ID**, so you need to load this module as well. (This requirement will not be necessary in version 2.1 and later, because of a more powerful APR version.) The ID token is attached to the request under the name `forensic-id`, which can be added to the transfer log using the `%{forensic-id}n` format string.

The argument, which specifies the location to which the logs will be written, can take one of the following two types of values:

filename A filename, relative to the **SERVERROOT**.

pipe The pipe character "|", followed by the path to a program to receive the log information on its standard input. The program name can be specified relative to the **SERVERROOT** directive.



Security:

If a program is used, then it will be run as the user who started httpd. This will be root if the server was started by root; be sure that the program is secure or switches to a less privileged user.



Note

When entering a file path on non-Unix platforms, care should be taken to make sure that only forward slashes are used even though the platform may allow the use of back slashes. In general it is a good idea to always use forward slashes throughout the configuration files.

10.39 Apache Module mod_logio

Description:	Logging of input and output bytes per request
Status:	Extension
ModuleIdentifier:	logio_module
SourceFile:	mod_logio.c

Summary

This module provides the logging of input and output number of bytes received/sent per request. The numbers reflect the actual bytes as received on the network, which then takes into account the headers and bodies of requests and responses. The counting is done before SSL/TLS on input and after SSL/TLS on output, so the numbers will correctly reflect any changes made by encryption.

This module requires [MOD_LOG_CONFIG](#).

Directives This module provides no directives.

See also

- [MOD_LOG_CONFIG](#)
- Apache Log Files (p. 29)

Custom Log Formats

This modules adds two new logging directives. The characteristics of the request itself are logged by placing "%" directives in the format string, which are replaced in the log file by the values as follows:

FormatString	Description
%. . . I	Bytes received, including request and headers, cannot be zero.
%. . . O	Bytes sent, including headers, cannot be zero.

Usually, the functionality is used like this:

Combined I/O log format: "%h %l %u %t \"%r\" %>s %b \"%{Referer}i\"
\"%{User-agent}i\" %I %O"

10.40 Apache Module mod_mem_cache

Description:	Content cache keyed to URIs
Status:	Experimental
ModuleIdentifier:	mem_cache_module
SourceFile:	mod_mem_cache.c

Summary



This module is experimental. Documentation is still under development...

This module *requires* the service of [MOD_CACHE](#). It acts as a support module for [MOD_CACHE](#) and provides a memory based storage manager. [MOD_MEM_CACHE](#) can be configured to operate in two modes: caching open file descriptors or caching objects in heap storage. [MOD_MEM_CACHE](#) is most useful when used to cache locally generated content or to cache backend server content for [MOD_PROXY](#) configured for [PROXYPASS](#) (aka reverse proxy).

Content is stored in and retrieved from the cache using URI based keys. Content with access protection is not cached.

Directives

- [MCacheMaxObjectCount](#)
- [MCacheMaxObjectSize](#)
- [MCacheMaxStreamingBuffer](#)
- [MCacheMinObjectSize](#)
- [MCacheRemovalAlgorithm](#)
- [MCacheSize](#)

See also

- [MOD_CACHE](#)
- [MOD_DISK_CACHE](#)

MCacheMaxObjectCount Directive

Description:	The maximum number of objects allowed to be placed in the cache
Syntax:	<code>MCacheMaxObjectCount value</code>
Default:	<code>MCacheMaxObjectCount 1009</code>
Context:	server config
Status:	Experimental
Module:	mod_mem_cache

The [MCACHEMAXOBJECTCOUNT](#) directive sets the maximum number of objects to be cached. The value is used to create the open hash table. If a new object needs to be inserted in the cache and the maximum number of objects has been reached, an object will be removed to allow the new object to be cached. The object to be removed is selected using the algorithm specified by [MCACHEREMOVALALGORITHM](#).

Example

```
MCacheMaxObjectCount 13001
```

MCacheMaxObjectSize Directive

Description:	The maximum size (in bytes) of a document allowed in the cache
Syntax:	MCacheMaxObjectSize bytes
Default:	MCacheMaxObjectSize 10000
Context:	server config
Status:	Experimental
Module:	mod_mem_cache

The `MCACHEMAXOBJECTSIZE` directive sets the maximum allowable size, in bytes, of a document for it to be considered cacheable.

Example

```
MCacheMaxObjectSize 6400000
```

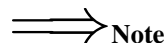

Note

The value of `MCACHEMAXOBJECTSIZE` must be greater than the value specified by the `MCACHEMINOBJECTSIZE` directive.

MCacheMaxStreamingBuffer Directive

Description:	Maximum amount of a streamed response to buffer in memory before declaring the response uncacheable
Syntax:	MCacheMaxStreamingBuffer size_in_bytes
Default:	MCacheMaxStreamingBuffer the smaller of 100000 or MCacheMaxObjectSize
Context:	server config
Status:	Experimental
Module:	mod_mem_cache

The `MCACHEMAXSTREAMINGBUFFER` directive specifies the maximum number of bytes of a streamed response to buffer before deciding that the response is too big to cache. A streamed response is one in which the entire content is not immediately available and in which the `Content-Length` may not be known. Sources of streaming responses include proxied responses and the output of CGI scripts. By default, a streamed response will *not* be cached unless it has a `Content-Length` header. The reason for this is to avoid using a large amount of memory to buffer a partial response that might end up being too large to fit in the cache. The `MCACHEMAXSTREAMINGBUFFER` directive allows buffering of streamed responses that don't contain a `Content-Length` up to the specified maximum amount of space. If the maximum buffer space is reached, the buffered content is discarded and the attempt to cache is abandoned.



Note:

Using a nonzero value for `MCACHEMAXSTREAMINGBUFFER` will not delay the transmission of the response to the client. As soon as `MOD_MEM_CACHE` copies a block of streamed content into a buffer, it sends the block on to the next output filter for delivery to the client.

```
# Enable caching of streamed responses up to 64KB:
MCacheMaxStreamingBuffer 65536
```

MCacheMinObjectSize Directive

Description:	The minimum size (in bytes) of a document to be allowed in the cache
Syntax:	MCacheMinObjectSize bytes
Default:	MCacheMinObjectSize 0
Context:	server config
Status:	Experimental
Module:	mod_mem_cache

The [MCACHEMINOBJECTSIZE](#) directive sets the minimum size in bytes of a document for it to be considered cacheable.

Example

```
MCacheMinObjectSize 10000
```

MCacheRemovalAlgorithm Directive

Description:	The algorithm used to select documents for removal from the cache
Syntax:	MCacheRemovalAlgorithm LRU GDSF
Default:	MCacheRemovalAlgorithm GDSF
Context:	server config
Status:	Experimental
Module:	mod_mem_cache

The [MCACHEREMOVALALGORITHM](#) directive specifies the algorithm used to select documents for removal from the cache. Two choices are available:

LRU (Least Recently Used) LRU removes the documents that have not been accessed for the longest time.

GDSF (GreedyDual-Size) GDSF assigns a priority to cached documents based on the cost of a cache miss and the size of the document. Documents with the lowest priority are removed first.

Example

```
MCacheRemovalAlgorithm GDSF
MCacheRemovalAlgorithm LRU
```

MCacheSize Directive

Description:	The maximum amount of memory used by the cache in KBytes
Syntax:	MCacheSize KBytes
Default:	MCacheSize 100
Context:	server config
Status:	Experimental
Module:	mod_mem_cache

The [MCACHESIZE](#) directive sets the maximum amount of memory to be used by the cache, in KBytes (1024-byte units). If a new object needs to be inserted in the cache and the size of the object is greater than the remaining memory, objects will be removed until the new object can be cached. The object to be removed is selected using the algorithm specified by [MCACHEREMOVALALGORITHM](#).

Example

```
MCacheSize 700000
```

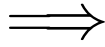
**Note**

The **MCACHESIZE** value must be greater than the value specified by the **MCACHEMAXOBJECTSIZE** directive.

10.41 Apache Module mod_mime

Description:	Associates the requested filename's extensions with the file's behavior (handlers and filters) and content (mime-type, language, character set and encoding)
Status:	Base
ModuleIdentifier:	mime_module
SourceFile:	mod_mime.c

Summary

This module is used to associate various bits of "meta information" with files by their filename extensions. This information relates the filename of the document to its mime-type, language, character set and encoding. This information is sent to the browser, and participates in content negotiation, so the user's preferences are respected when choosing one of several possible files to serve. See [MOD_NEGOTIATION](#) for more information about content negotiation (p. 47).

The directives [ADDCHARSET](#), [ADDENCODING](#), [ADDLANGUAGE](#) and [ADDTYPE](#) are all used to map file extensions onto the meta-information for that file. Respectively they set the character set, content-encoding, content-language, and MIME-type (content-type) of documents. The directive [TYPESCONFIG](#) is used to specify a file which also maps extensions onto MIME types.

In addition, [MOD_MIME](#) may define the handler (p. 65) and filters (p. 67) that originate and process content. The directives [ADDHANDLER](#), [ADDOUTPUTFILTER](#), and [ADDINPUTFILTER](#) control the modules or scripts that serve the document. The [MULTIVIEWSMATCH](#) directive allows [MOD_NEGOTIATION](#) to consider these file extensions to be included when testing Multiviews matches.

While [MOD_MIME](#) associates meta-information with filename extensions, the [CORE](#) server provides directives that are used to associate all the files in a given container (*e.g.*, [<LOCATION>](#), [<DIRECTORY>](#), or [<FILES>](#)) with particular meta-information. These directives include [FORCETYPE](#), [SETHANDLER](#), [SETINPUTFILTER](#), and [SETOUTPUTFILTER](#). The core directives override any filename extension mappings defined in [MOD_MIME](#).

Note that changing the meta-information for a file does not change the value of the `Last-Modified` header. Thus, previously cached copies may still be used by a client or proxy, with the previous headers. If you change the meta-information (language, content type, character set or encoding) you may need to 'touch' affected files (updating their last modified date) to ensure that all visitors are receive the corrected content headers.

Directives

- [AddCharset](#)
- [AddEncoding](#)
- [AddHandler](#)
- [AddInputFilter](#)
- [AddLanguage](#)
- [AddOutputFilter](#)
- [AddType](#)
- [DefaultLanguage](#)
- [ModMimeUsePathInfo](#)
- [MultiviewsMatch](#)
- [RemoveCharset](#)
- [RemoveEncoding](#)
- [RemoveHandler](#)

- RemoveInputFilter
- RemoveLanguage
- RemoveOutputFilter
- RemoveType
- TypesConfig

See also

- [MIMEMAGICFILE](#)
- [ADDDFAULTCHARSET](#)
- [FORCETYPE](#)
- [DEFAULTTYPE](#)
- [SETHANDLER](#)
- [SETINPUTFILTER](#)
- [SETOUTPUTFILTER](#)

Files with Multiple Extensions

Files can have more than one extension, and the order of the extensions is *normally* irrelevant. For example, if the file `welcome.html.fr` maps onto content type `text/html` and language French then the file `welcome.fr.html` will map onto exactly the same information. If more than one extension is given which maps onto the same type of meta-information, then the one to the right will be used, except for languages and content encodings. For example, if `.gif` maps to the MIME-type `image/gif` and `.html` maps to the MIME-type `text/html`, then the file `welcome.gif.html` will be associated with the MIME-type `text/html`.

Languages and content encodings are treated accumulative, because one can assign more than one language or encoding to a particular resource. For example, the file `welcome.html.en.de` will be delivered with `Content-Language: en, de` and `Content-Type: text/html`.

Care should be taken when a file with multiple extensions gets associated with both a MIME-type and a handler. This will usually result in the request being by the module associated with the handler. For example, if the `.imap` extension is mapped to the handler `imap-file` (from [MOD_IMAP](#)) and the `.html` extension is mapped to the MIME-type `text/html`, then the file `world.imap.html` will be associated with both the `imap-file` handler and `text/html` MIME-type. When it is processed, the `imap-file` handler will be used, and so it will be treated as a [MOD_IMAP](#) `imagemap` file.

Content encoding

A file of a particular MIME type can additionally be encoded a particular way to simplify transmission over the Internet. While this usually will refer to compression, such as `gzip`, it can also refer to encryption, such as `pgp` or to an encoding such as `UUencoding`, which is designed for transmitting a binary file in an ASCII (text) format.

The HTTP/1.1 RFC²², section 14.11 puts it this way:

The Content-Encoding entity-header field is used as a modifier to the media-type. When present, its value indicates what additional content codings have been applied to the entity-body, and thus what decoding mechanisms must be applied in order to obtain the media-type referenced by the Content-Type header field. Content-Encoding is primarily used to allow a document to be compressed without losing the identity of its underlying media type.

²²<http://www.ietf.org/rfc/rfc2616.txt>

By using more than one file extension (see section above about multiple file extensions), you can indicate that a file is of a particular *type*, and also has a particular *encoding*.

For example, you may have a file which is a Microsoft Word document, which is pkzipped to reduce its size. If the `.doc` extension is associated with the Microsoft Word file type, and the `.zip` extension is associated with the pkzip file encoding, then the file `Resume.doc.zip` would be known to be a pkzip'ed Word document.

Apache sends a `Content-encoding` header with the resource, in order to tell the client browser about the encoding method.

```
Content-encoding:  pkzip
```

Character sets and languages

In addition to file type and the file encoding, another important piece of information is what language a particular document is in, and in what character set the file should be displayed. For example, the document might be written in the Vietnamese alphabet, or in Cyrillic, and should be displayed as such. This information, also, is transmitted in HTTP headers.

The character set, language, encoding and mime type are all used in the process of content negotiation (See [MOD_NEGOTIATION](#)) to determine which document to give to the client, when there are alternative documents in more than one character set, language, encoding or mime type. All filename extensions associations created with [ADDCHARSET](#), [ADDENCODING](#), [ADDLANGUAGE](#) and [ADDTYPE](#) directives (and extensions listed in the [MIMEMAGICFILE](#)) participate in this select process. Filename extensions that are only associated using the [ADDHANDLER](#), [ADDINPUTFILTER](#) or [ADDOUTPUTFILTER](#) directives may be included or excluded from matching by using the [MULTIVIEWSMATCH](#) directive.

Charset

To convey this further information, Apache optionally sends a `Content-Language` header, to specify the language that the document is in, and can append additional information onto the `Content-Type` header to indicate the particular character set that should be used to correctly render the information.

```
Content-Language:  en, fr
Content-Type:     text/plain; charset=ISO-8859-1
```

The language specification is the two-letter abbreviation for the language. The `charset` is the name of the particular character set which should be used.

AddCharset Directive

Description:	Maps the given filename extensions to the specified content charset
Syntax:	<code>AddCharset charset extension [extension] ...</code>
Context:	server config, virtual host, directory, <code>.htaccess</code>
Override:	FileInfo
Status:	Base
Module:	<code>mod_mime</code>

The [ADDCHARSET](#) directive maps the given filename extensions to the specified content charset. `charset` is the MIME charset parameter²³ of filenames containing extension. This mapping is added to any already in force, overriding any mappings that already exist for the same extension.

²³<http://www.iana.org/assignments/character-sets>

Example

```
AddLanguage ja .ja
AddCharset EUC-JP .euc
AddCharset ISO-2022-JP .jis
AddCharset SHIFT_JIS .sjis
```

Then the document `xxxx.ja.jis` will be treated as being a Japanese document whose charset is `ISO-2022-JP` (as will the document `xxxx.jis.ja`). The `ADDCHARSET` directive is useful for both to inform the client about the character encoding of the document so that the document can be interpreted and displayed appropriately, and for content negotiation (p. 47), where the server returns one from several documents based on the client's charset preference.

The extension argument is case-insensitive, and can be specified with or without a leading dot.

See also

- [MOD_NEGOTIATION](#)
- [ADDDFAULTCHARSET](#)

AddEncoding Directive

Description:	Maps the given filename extensions to the specified encoding type
Syntax:	<code>AddEncoding MIME-enc extension [extension] ...</code>
Context:	server config, virtual host, directory, <code>.htaccess</code>
Override:	<code>FileInfo</code>
Status:	Base
Module:	<code>mod_mime</code>

The `ADDENCODING` directive maps the given filename extensions to the specified encoding type. `MIME-enc` is the MIME encoding to use for documents containing the extension. This mapping is added to any already in force, overriding any mappings that already exist for the same extension.

Example

```
AddEncoding x-gzip .gz
AddEncoding x-compress .Z
```

This will cause filenames containing the `.gz` extension to be marked as encoded using the `x-gzip` encoding, and filenames containing the `.Z` extension to be marked as encoded with `x-compress`.

Old clients expect `x-gzip` and `x-compress`, however the standard dictates that they're equivalent to `gzip` and `compress` respectively. Apache does content encoding comparisons by ignoring any leading `x-`. When responding with an encoding Apache will use whatever form (*i.e.*, `x-foo` or `foo`) the client requested. If the client didn't specifically request a particular form Apache will use the form given by the `AddEncoding` directive. To make this long story short, you should always use `x-gzip` and `x-compress` for these two specific encodings. More recent encodings, such as `deflate` should be specified without the `x-`.

The extension argument is case-insensitive, and can be specified with or without a leading dot.

AddHandler Directive

Description:	Maps the filename extensions to the specified handler
Syntax:	AddHandler handler-name extension [extension] ...
Context:	server config, virtual host, directory, .htaccess
Override:	FileInfo
Status:	Base
Module:	mod_mime

Files having the name extension will be served by the specified handler-name (p. 65) . This mapping is added to any already in force, overriding any mappings that already exist for the same extension. For example, to activate CGI scripts with the file extension `.cgi`, you might use:

```
AddHandler cgi-script .cgi
```

Once that has been put into your `httpd.conf` file, any file containing the `.cgi` extension will be treated as a CGI program.

The extension argument is case-insensitive, and can be specified with or without a leading dot.

See also

- [SETHANDLER](#)

AddInputFilter Directive

Description:	Maps filename extensions to the filters that will process client requests
Syntax:	AddInputFilter filter[;filter...] extension [extension] ...
Context:	server config, virtual host, directory, .htaccess
Override:	FileInfo
Status:	Base
Module:	mod_mime
Compatibility:	AddInputFilter is only available in Apache 2.0.26 and later.

[ADDINPUTFILTER](#) maps the filename extension extension to the filters (p. 67) which will process client requests and POST input when they are received by the server. This is in addition to any filters defined elsewhere, including the [SETINPUTFILTER](#) directive. This mapping is merged over any already in force, overriding any mappings that already exist for the same extension.

If more than one filter is specified, they must be separated by semicolons in the order in which they should process the content. Both the filter and extension arguments are case-insensitive, and the extension may be specified with or without a leading dot.

See also

- [REMOVEINPUTFILTER](#)
- [SETINPUTFILTER](#)

AddLanguage Directive

Description:	Maps the given filename extension to the specified content language
Syntax:	AddLanguage MIME-lang extension [extension] ...
Context:	server config, virtual host, directory, .htaccess
Override:	FileInfo
Status:	Base
Module:	mod_mime

The [ADDLANGUAGE](#) directive maps the given filename extension to the specified content language. MIME-lang is the MIME language of filenames containing extension. This mapping is added to any already in force, overriding any mappings that already exist for the same extension.

Example

```
AddEncoding x-compress .Z
AddLanguage en .en
AddLanguage fr .fr
```

Then the document `xxxx.en.Z` will be treated as being a compressed English document (as will the document `xxxx.Z.en`). Although the content language is reported to the client, the browser is unlikely to use this information. The [ADDLANGUAGE](#) directive is more useful for content negotiation (p. 47), where the server returns one from several documents based on the client's language preference.

If multiple language assignments are made for the same extension, the last one encountered is the one that is used. That is, for the case of:

```
AddLanguage en .en
AddLanguage en-gb .en
AddLanguage en-us .en
```

documents with the extension `.en` would be treated as being `en-us`.

The extension argument is case-insensitive, and can be specified with or without a leading dot.

See also

- [MOD_NEGOTIATION](#)

AddOutputFilter Directive

Description:	Maps filename extensions to the filters that will process responses from the server
Syntax:	<code>AddOutputFilter filter[;filter...] extension [extension] ...</code>
Context:	server config, virtual host, directory, <code>.htaccess</code>
Override:	FileInfo
Status:	Base
Module:	<code>mod_mime</code>
Compatibility:	<code>AddOutputFilter</code> is only available in Apache 2.0.26 and later.

The [ADDOUTPUTFILTER](#) directive maps the filename extension extension to the filters (p. 67) which will process responses from the server before they are sent to the client. This is in addition to any filters defined elsewhere, including [SETOUTPUTFILTER](#) and [ADDOUTPUTFILTERBYTYPE](#) directive. This mapping is merged over any already in force, overriding any mappings that already exist for the same extension.

For example, the following configuration will process all `.shtml` files for server-side includes and will then compress the output using [MOD_DEFLATE](#).

```
AddOutputFilter INCLUDES;DEFLATE shtml
```

If more than one filter is specified, they must be separated by semicolons in the order in which they should process the content. Both the filter and extension arguments are case-insensitive, and the extension may be specified with or without a leading dot.

See also

- [REMOVEOUTPUTFILTER](#)
- [SETOUTPUTFILTER](#)

AddType Directive

Description:	Maps the given filename extensions onto the specified content type
Syntax:	AddType MIME-type extension [extension] ...
Context:	server config, virtual host, directory, .htaccess
Override:	FileInfo
Status:	Base
Module:	mod_mime

The [ADDTYPE](#) directive maps the given filename extensions onto the specified content type. MIME-type is the MIME type to use for filenames containing extension. This mapping is added to any already in force, overriding any mappings that already exist for the same extension. This directive can be used to add mappings not listed in the MIME types file (see the [TYPESCONFIG](#) directive).

Example

```
AddType image/gif .gif
```

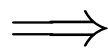

It is recommended that new MIME types be added using the [ADDTYPE](#) directive rather than changing the [TYPESCONFIG](#) file.

The extension argument is case-insensitive, and can be specified with or without a leading dot.

See also

- [DEFAULTTYPE](#)
- [FORCETYPE](#)

DefaultLanguage Directive

Description:	Sets all files in the given scope to the specified language
Syntax:	DefaultLanguage MIME-lang
Context:	server config, virtual host, directory, .htaccess
Override:	FileInfo
Status:	Base
Module:	mod_mime

The [DEFAULTLANGUAGE](#) directive tells Apache that all files in the directive's scope (*e.g.*, all files covered by the current [<DIRECTORY>](#) container) that don't have an explicit language extension (such as `.fr` or `.de` as configured by [ADDLANGUAGE](#)) should be considered to be in the specified MIME-lang language. This allows entire directories to be marked as containing Dutch content, for instance, without having to rename each file. Note that unlike using extensions to specify languages, [DEFAULTLANGUAGE](#) can only specify a single language.

If no [DEFAULTLANGUAGE](#) directive is in force, and a file does not have any language extensions as configured by [ADDLANGUAGE](#), then that file will be considered to have no language attribute.

Example

```
DefaultLanguage en
```

See also

- [MOD_NEGOTIATION](#)

ModMimeUsePathInfo Directive

Description:	Tells MOD_MIME to treat <code>path.info</code> components as part of the filename
Syntax:	<code>ModMimeUsePathInfo On Off</code>
Default:	<code>ModMimeUsePathInfo Off</code>
Context:	directory
Status:	Base
Module:	<code>mod_mime</code>
Compatibility:	Available in Apache 2.0.41 and later

The [MODMIMEUSEPATHINFO](#) directive is used to combine the filename with the `path.info` URL component to apply [MOD_MIME](#)'s directives to the request. The default value is `Off` - therefore, the `path.info` component is ignored.

This directive is recommended when you have a virtual filesystem.

Example

```
ModMimeUsePathInfo On
```

If you have a request for `/bar/foo.shtml` where `/bar` is a Location and [MODMIMEUSEPATHINFO](#) is `On`, [MOD_MIME](#) will treat the incoming request as `/bar/foo.shtml` and directives like `AddOutputFilter INCLUDES .shtml` will add the `INCLUDES` filter to the request. If [MODMIMEUSEPATHINFO](#) is not set, the `INCLUDES` filter will not be added.

See also

- [ACCEPTPATHINFO](#)

MultiviewsMatch Directive

Description:	The types of files that will be included when searching for a matching file with <code>MultiViews</code>
Syntax:	<code>MultiviewsMatch Any NegotiatedOnly Filters Handlers</code> <code>[Handlers Filters]</code>
Default:	<code>MultiviewsMatch NegotiatedOnly</code>
Context:	server config, virtual host, directory, <code>.htaccess</code>
Override:	<code>FileInfo</code>
Status:	Base
Module:	<code>mod_mime</code>
Compatibility:	Available in Apache 2.0.26 and later.

[MULTIVIEWSMATCH](#) permits three different behaviors for `mod_negotiation` (p. 499)'s `MultiViews` feature. `MultiViews` allows a request for a file, *e.g.* `index.html`, to match any negotiated extensions following the base request, *e.g.* `index.html.en`, `index.html.fr`, or `index.html.gz`.

The `NegotiatedOnly` option provides that every extension following the base name must correlate to a recognized [MOD_MIME](#) extension for content negotiation, *e.g.* `Charset`, `Content-Type`, `Language`, or `Encoding`. This is the strictest implementation with the fewest unexpected side effects, and is the default behavior.

To include extensions associated with `Handlers` and/or `Filters`, set the [MULTIVIEWSMATCH](#) directive to either `Handlers`, `Filters`, or both option keywords. If all other factors are equal, the smallest file will be served, *e.g.* in deciding between `index.html.cgi` of 500 bytes and `index.html.pl` of 1000 bytes, the `.cgi` file would win in this example. Users of `.asis` files might prefer to use the `Handler` option, if `.asis` files are associated with the `asis-handler`.

You may finally allow `Any` extensions to match, even if [MOD_MIME](#) doesn't recognize the extension. This was the behavior in Apache 1.3, and can cause unpredictable results, such as serving `.old` or `.bak` files the webmaster never expected to be served.

For example, the following configuration will allow handlers and filters to participate in Multiviews, but will exclude unknown files:

```
MultiviewsMatch Handlers Filters
```

See also

- [OPTIONS](#)
- [MOD_NEGOTIATION](#)

RemoveCharset Directive

Description:	Removes any character set associations for a set of file extensions
Syntax:	RemoveCharset extension [extension] ...
Context:	virtual host, directory, .htaccess
Override:	FileInfo
Status:	Base
Module:	mod_mime
Compatibility:	RemoveCharset is only available in Apache 2.0.24 and later.

The [REMOVECHARSET](#) directive removes any character set associations for files with the given extensions. This allows .htaccess files in subdirectories to undo any associations inherited from parent directories or the server config files.

The extension argument is case-insensitive, and can be specified with or without a leading dot.

Example

```
RemoveCharset .html .shtml
```

RemoveEncoding Directive

Description:	Removes any content encoding associations for a set of file extensions
Syntax:	RemoveEncoding extension [extension] ...
Context:	virtual host, directory, .htaccess
Override:	FileInfo
Status:	Base
Module:	mod_mime

The [REMOVEENCODING](#) directive removes any encoding associations for files with the given extensions. This allows .htaccess files in subdirectories to undo any associations inherited from parent directories or the server config files. An example of its use might be:

```
/foo/.htaccess:
AddEncoding x-gzip .gz
AddType text/plain .asc
<Files *.gz.asc>
    RemoveEncoding .gz
</Files>
```

This will cause `foo.gz` to be marked as being encoded with the `gzip` method, but `foo.gz.asc` as an unencoded plaintext file.

⇒ Note

`REMOVEENCODING` directives are processed *after* any `ADDENCODING` directives, so it is possible they may undo the effects of the latter if both occur within the same directory configuration.

The extension argument is case-insensitive, and can be specified with or without a leading dot.

RemoveHandler Directive

Description:	Removes any handler associations for a set of file extensions
Syntax:	<code>RemoveHandler extension [extension] ...</code>
Context:	virtual host, directory, <code>.htaccess</code>
Override:	<code>FileInfo</code>
Status:	<code>Base</code>
Module:	<code>mod_mime</code>

The `REMOVEHANDLER` directive removes any handler associations for files with the given extensions. This allows `.htaccess` files in subdirectories to undo any associations inherited from parent directories or the server config files. An example of its use might be:

```
/foo/.htaccess:
AddHandler server-parsed .html
```

```
/foo/bar/.htaccess:
RemoveHandler .html
```

This has the effect of returning `.html` files in the `/foo/bar` directory to being treated as normal files, rather than as candidates for parsing (see the `MOD_INCLUDE` module).

The extension argument is case-insensitive, and can be specified with or without a leading dot.

RemoveInputFilter Directive

Description:	Removes any input filter associations for a set of file extensions
Syntax:	<code>RemoveInputFilter extension [extension] ...</code>
Context:	virtual host, directory, <code>.htaccess</code>
Override:	<code>FileInfo</code>
Status:	<code>Base</code>
Module:	<code>mod_mime</code>
Compatibility:	<code>RemoveInputFilter</code> is only available in Apache 2.0.26 and later.

The `REMOVEINPUTFILTER` directive removes any input filter (p. 67) associations for files with the given extensions. This allows `.htaccess` files in subdirectories to undo any associations inherited from parent directories or the server config files.

The extension argument is case-insensitive, and can be specified with or without a leading dot.

See also

- [ADDINPUTFILTER](#)
- [SETINPUTFILTER](#)

RemoveLanguage Directive

Description:	Removes any language associations for a set of file extensions
Syntax:	<code>RemoveLanguage extension [extension] ...</code>
Context:	virtual host, directory, <code>.htaccess</code>
Override:	FileInfo
Status:	Base
Module:	<code>mod_mime</code>
Compatibility:	RemoveLanguage is only available in Apache 2.0.24 and later.

The [REMOVELANGUAGE](#) directive removes any language associations for files with the given extensions. This allows `.htaccess` files in subdirectories to undo any associations inherited from parent directories or the server config files.

The extension argument is case-insensitive, and can be specified with or without a leading dot.

RemoveOutputFilter Directive

Description:	Removes any output filter associations for a set of file extensions
Syntax:	<code>RemoveOutputFilter extension [extension] ...</code>
Context:	virtual host, directory, <code>.htaccess</code>
Override:	FileInfo
Status:	Base
Module:	<code>mod_mime</code>
Compatibility:	RemoveOutputFilter is only available in Apache 2.0.26 and later.

The [REMOVEOUTPUTFILTER](#) directive removes any output filter (p. 67) associations for files with the given extensions. This allows `.htaccess` files in subdirectories to undo any associations inherited from parent directories or the server config files.

The extension argument is case-insensitive, and can be specified with or without a leading dot.

Example

```
RemoveOutputFilter shtml
```

See also

- [ADDOUTPUTFILTER](#)

RemoveType Directive

Description:	Removes any content type associations for a set of file extensions
Syntax:	<code>RemoveType extension [extension] ...</code>
Context:	virtual host, directory, <code>.htaccess</code>
Override:	FileInfo
Status:	Base
Module:	<code>mod_mime</code>

The [REMOVETYPE](#) directive removes any MIME type associations for files with the given extensions. This allows `.htaccess` files in subdirectories to undo any associations inherited from parent directories or the server config files. An example of its use might be:

```
/foo/.htaccess:  
RemoveType .cgi
```

This will remove any special handling of `.cgi` files in the `/foo/` directory and any beneath it, causing the files to be treated as being of the `DEFAULTTYPE`.

⇒ Note

`REMOVETYPE` directives are processed *after* any `ADDTYPE` directives, so it is possible they may undo the effects of the latter if both occur within the same directory configuration.

The extension argument is case-insensitive, and can be specified with or without a leading dot.

TypesConfig Directive

Description:	The location of the <code>mime.types</code> file
Syntax:	<code>TypesConfig file-path</code>
Default:	<code>TypesConfig conf/mime.types</code>
Context:	server config
Status:	Base
Module:	<code>mod_mime</code>

The `TYPESCONFIG` directive sets the location of the MIME types configuration file. `File-path` is relative to the `SERVERROOT`. This file sets the default list of mappings from filename extensions to content types. Most administrators use the provided `mime.types` file, which associates common filename extensions with IANA registered content types. The current list is maintained at <http://www.iana.org/assignments/media-types/index.html>. This simplifies the `httpd.conf` file by providing the majority of media-type definitions, and may be overridden by `ADDTYPE` directives as needed. You should not edit the `mime.types` file, because it may be replaced when you upgrade your server.

The file contains lines in the format of the arguments to an `ADDTYPE` directive:

```
MIME-type [extension] ...
```

The case of the extension does not matter. Blank lines, and lines beginning with a hash character (`#`) are ignored.

⇒

Please do **not** send requests to the Apache HTTP Server Project to add any new entries in the distributed `mime.types` file unless (1) they are already registered with IANA, and (2) they use widely accepted, non-conflicting filename extensions across platforms. `category/x-subtype` requests will be automatically rejected, as will any new two-letter extensions as they will likely conflict later with the already crowded language and character set namespace.

See also

- [MOD_MIME_MAGIC](#)

10.42 Apache Module mod_mime_magic

Description:	Determines the MIME type of a file by looking at a few bytes of its contents
Status:	Extension
ModuleIdentifier:	mime_magic_module
SourceFile:	mod_mime_magic.c

Summary

This module determines the MIME type of files in the same way the Unix `file(1)` command works: it looks at the first few bytes of the file. It is intended as a "second line of defense" for cases that `MOD_MIME` can't resolve.

This module is derived from a free version of the `file(1)` command for Unix, which uses "magic numbers" and other hints from a file's contents to figure out what the contents are. This module is active only if the magic file is specified by the `MIMEMAGICFILE` directive.

Directives

- `MimeMagicFile`

Format of the Magic File

The contents of the file are plain ASCII text in 4-5 columns. Blank lines are allowed but ignored. Commented lines use a hash mark (#). The remaining lines are parsed for the following columns:

Column	Description																						
1	byte number to begin checking from ">" indicates a dependency upon the previous non->" line																						
2	type of data to match <table border="1"> <tr> <td>byte</td> <td>single character</td> </tr> <tr> <td>short</td> <td>machine-order 16-bit integer</td> </tr> <tr> <td>long</td> <td>machine-order 32-bit integer</td> </tr> <tr> <td>string</td> <td>arbitrary-length string</td> </tr> <tr> <td>date</td> <td>long integer date (seconds since Unix epoch/1970)</td> </tr> <tr> <td>beshort</td> <td>big-endian 16-bit integer</td> </tr> <tr> <td>belong</td> <td>big-endian 32-bit integer</td> </tr> <tr> <td>bedate</td> <td>big-endian 32-bit integer date</td> </tr> <tr> <td>leshort</td> <td>little-endian 16-bit integer</td> </tr> <tr> <td>lelong</td> <td>little-endian 32-bit integer</td> </tr> <tr> <td>ledate</td> <td>little-endian 32-bit integer date</td> </tr> </table>	byte	single character	short	machine-order 16-bit integer	long	machine-order 32-bit integer	string	arbitrary-length string	date	long integer date (seconds since Unix epoch/1970)	beshort	big-endian 16-bit integer	belong	big-endian 32-bit integer	bedate	big-endian 32-bit integer date	leshort	little-endian 16-bit integer	lelong	little-endian 32-bit integer	ledate	little-endian 32-bit integer date
byte	single character																						
short	machine-order 16-bit integer																						
long	machine-order 32-bit integer																						
string	arbitrary-length string																						
date	long integer date (seconds since Unix epoch/1970)																						
beshort	big-endian 16-bit integer																						
belong	big-endian 32-bit integer																						
bedate	big-endian 32-bit integer date																						
leshort	little-endian 16-bit integer																						
lelong	little-endian 32-bit integer																						
ledate	little-endian 32-bit integer date																						
3	contents of data to match																						
4	MIME type if matched																						
5	MIME encoding if matched (optional)																						

For example, the following magic file lines would recognize some audio formats:

```
# Sun/NeXT audio data
0      string      .snd
>12    belong      1      audio/basic
>12    belong      2      audio/basic
>12    belong      3      audio/basic
>12    belong      4      audio/basic
>12    belong      5      audio/basic
>12    belong      6      audio/basic
>12    belong      7      audio/basic
>12    belong      23     audio/x-adpcm
```

Or these would recognize the difference between *.doc files containing Microsoft Word or FrameMaker documents. (These are incompatible file formats which use the same file suffix.)

```
# Frame
0      string      \<MakerFile      application/x-frame
0      string      \<MIFFfile      application/x-frame
0      string      \<MakerDictionary application/x-frame
0      string      \<MakerScreenFon application/x-frame
0      string      \<MML          application/x-frame
0      string      \<Book          application/x-frame
0      string      \<Maker          application/x-frame

# MS-Word
0      string      \376\067\0\043      application/msword
0      string      \320\317\021\340\241\261 application/msword
0      string      \333\245-\0\0\0 application/msword
```

An optional MIME encoding can be included as a fifth column. For example, this can recognize gzipped files and set the encoding for them.

```
# gzip (GNU zip, not to be confused with
#      [Info-ZIP/PKWARE] zip archiver)

0      string      \037\213 application/octet-stream x-gzip
```

Performance Issues

This module is not for every system. If your system is barely keeping up with its load or if you're performing a web server benchmark, you may not want to enable this because the processing is not free.

However, an effort was made to improve the performance of the original `file(1)` code to make it fit in a busy web server. It was designed for a server where there are thousands of users who publish their own documents. This is probably very common on intranets. Many times, it's helpful if the server can make more intelligent decisions about a file's contents than the file name allows ...even if just to reduce the "why doesn't my page work" calls when users improperly name their own files. You have to decide if the extra work suits your environment.

Notes

The following notes apply to the [MOD_MIME_MAGIC](#) module and are included here for compliance with contributors' copyright restrictions that require their acknowledgment.

⇒⇒ mod_mime_magic: MIME type lookup via file magic numbers
Copyright (c) 1996-1997 Cisco Systems, Inc.

This software was submitted by Cisco Systems to the Apache Group in July 1997. Future revisions and derivatives of this source code must acknowledge Cisco Systems as the original contributor of this module. All other licensing and usage conditions are those of the Apache Group.

Some of this code is derived from the free version of the file command originally posted to comp.sources.unix. Copyright info for that program is included below as required.

⇒⇒ - Copyright (c) Ian F. Darwin, 1987. Written by Ian F. Darwin.

This software is not subject to any license of the American Telephone and Telegraph Company or of the Regents of the University of California.

Permission is granted to anyone to use this software for any purpose on any computer system, and to alter it and redistribute it freely, subject to the following restrictions:

1. The author is not responsible for the consequences of use of this software, no matter how awful, even if they arise from flaws in it.
2. The origin of this software must not be misrepresented, either by explicit claim or by omission. Since few users ever read sources, credits must appear in the documentation.
3. Altered versions must be plainly marked as such, and must not be misrepresented as being the original software. Since few users ever read sources, credits must appear in the documentation.
4. This notice may not be removed or altered.

⇒⇒ For compliance with Mr Darwin's terms: this has been very significantly modified from the free "file" command.

- all-in-one file for compilation convenience when moving from one version of Apache to the next.
- Memory allocation is done through the Apache API's pool structure.
- All functions have had necessary Apache API request or server structures passed to them where necessary to call other Apache API routines. (*i.e.*, usually for logging, files, or memory allocation in itself or a called function.)
- struct magic has been converted from an array to a single-ended linked list because it only grows one record at a time, it's only accessed sequentially, and the Apache API has no equivalent of `realloc()`.
- Functions have been changed to get their parameters from the server configuration instead of globals. (It should be reentrant now but has not been tested in a threaded environment.)
- Places where it used to print results to stdout now saves them in a list where they're used to set the MIME type in the Apache request record.
- Command-line flags have been removed since they will never be used here.

MimeMagicFile Directive

Description:	Enable MIME-type determination based on file contents using the specified magic file
Syntax:	<code>MimeMagicFile file-path</code>
Context:	server config, virtual host
Status:	Extension
Module:	<code>mod_mime_magic</code>

The `MIMEMAGICFILE` directive can be used to enable this module, the default file is distributed at `conf/magic`. Non-rooted paths are relative to the `SERVERROOT`. Virtual hosts will use the same file as the main server unless a more specific setting is used, in which case the more specific setting overrides the main server's file.

Example

```
MimeMagicFile conf/magic
```

10.43 Apache Module mod_negotiation

Description:	Provides for content negotiation (p. 47)
Status:	Base
ModuleIdentifier:	negotiation_module
SourceFile:	mod_negotiation.c

Summary

Content negotiation, or more accurately content selection, is the selection of the document that best matches the clients capabilities, from one of several available documents. There are two implementations of this.

- A type map (a file with the handler `type-map`) which explicitly lists the files containing the variants.
- A MultiViews search (enabled by the `MultiViews` [OPTIONS](#)), where the server does an implicit filename pattern match, and choose from amongst the results.

Directives

- `CacheNegotiatedDocs`
- `ForceLanguagePriority`
- `LanguagePriority`

See also

- [OPTIONS](#)
- [MOD_MIME](#)
- [Content Negotiation \(p. 47\)](#)
- [Environment Variables \(p. 60\)](#)

Type maps

A type map has a format similar to RFC822 mail headers. It contains document descriptions separated by blank lines, with lines beginning with a hash character (`#`) treated as comments. A document description consists of several header records; records may be continued on multiple lines if the continuation lines start with spaces. The leading space will be deleted and the lines concatenated. A header record consists of a keyword name, which always ends in a colon, followed by a value. Whitespace is allowed between the header name and value, and between the tokens of value. The headers allowed are:

Content-Encoding: The encoding of the file. Apache only recognizes encodings that are defined by an [AD-ENCODING](#) directive. This normally includes the encodings `x-compress` for compress'd files, and `x-gzip` for gzip'd files. The `x-` prefix is ignored for encoding comparisons.

Content-Language: The language(s) of the variant, as an Internet standard language tag (RFC 1766²⁴). An example is `en`, meaning English. If the variant contains more than one language, they are separated by a comma.

Content-Length: The length of the file, in bytes. If this header is not present, then the actual length of the file is used.

²⁴<http://www.ietf.org/rfc/rfc1766.txt>

Content-Type: The MIME media type of the document, with optional parameters. Parameters are separated from the media type and from one another by a semi-colon, with a syntax of `name=value`. Common parameters include:

level an integer specifying the version of the media type. For `text/html` this defaults to 2, otherwise 0.

qs a floating-point number with a value in the range 0.0 to 1.0, indicating the relative 'quality' of this variant compared to the other available variants, independent of the client's capabilities. For example, a jpeg file is usually of higher source quality than an ascii file if it is attempting to represent a photograph. However, if the resource being represented is ascii art, then an ascii file would have a higher source quality than a jpeg file. All `qs` values are therefore specific to a given resource.

Example

```
Content-Type: image/jpeg; qs=0.8
```

URI: uri of the file containing the variant (of the given media type, encoded with the given content encoding). These are interpreted as URLs relative to the map file; they must be on the same server (!), and they must refer to files to which the client would be granted access if they were to be requested directly.

Body: New in Apache 2.0, the actual content of the resource may be included in the type-map file using the Body header. This header must contain a string that designates a delimiter for the body content. Then all following lines in the type map file will be considered part of the resource body until the delimiter string is found.

Example:

```
Body:----xyz----
<html>
<body>
<p>Content of the page.</p>
</body>
</html>
----xyz----
```

MultiViews

A MultiViews search is enabled by the MultiViews [OPTIONS](#). If the server receives a request for `/some/dir/foo` and `/some/dir/foo` does *not* exist, then the server reads the directory looking for all files named `foo.*`, and effectively fakes up a type map which names all those files, assigning them the same media types and content-encodings it would have if the client had asked for one of them by name. It then chooses the best match to the client's requirements, and returns that document.

The [MULTIVIEWSMATCH](#) directive configures whether Apache will consider files that do not have content negotiation meta-information assigned to them when choosing files.

CacheNegotiatedDocs Directive

Description:	Allows content-negotiated documents to be cached by proxy servers
Syntax:	CacheNegotiatedDocs On Off
Default:	CacheNegotiatedDocs Off
Context:	server config, virtual host
Status:	Base
Module:	mod_negotiation
Compatibility:	The syntax changed in version 2.0.

If set, this directive allows content-negotiated documents to be cached by proxy servers. This could mean that clients behind those proxys could retrieve versions of the documents that are not the best match for their abilities, but it will make caching more efficient.

This directive only applies to requests which come from HTTP/1.0 browsers. HTTP/1.1 provides much better control over the caching of negotiated documents, and this directive has no effect in responses to HTTP/1.1 requests.

Prior to version 2.0, `CACHENEGOTIATEDDOCS` did not take an argument; it was turned on by the presence of the directive by itself.

ForceLanguagePriority Directive

Description:	Action to take if a single acceptable document is not found
Syntax:	<code>ForceLanguagePriority None Prefer Fallback [Prefer Fallback]</code>
Default:	<code>ForceLanguagePriority Prefer</code>
Context:	server config, virtual host, directory, .htaccess
Override:	FileInfo
Status:	Base
Module:	mod_negotiation
Compatibility:	Available in version 2.0.30 and later

The `FORCELANGUAGEPRIORITY` directive uses the given `LANGUAGEPRIORITY` to satisfy negotiation where the server could otherwise not return a single matching document.

`ForceLanguagePriority Prefer` uses `LanguagePriority` to serve a one valid result, rather than returning an HTTP result 300 (MULTIPLE CHOICES) when there are several equally valid choices. If the directives below were given, and the user's `Accept-Language` header assigned `en` and `de` each as quality `.500` (equally acceptable) then the first matching variant, `en`, will be served.

```
LanguagePriority en fr de
ForceLanguagePriority Prefer
```

`ForceLanguagePriority Fallback` uses `LANGUAGEPRIORITY` to serve a valid result, rather than returning an HTTP result 406 (NOT ACCEPTABLE). If the directives below were given, and the user's `Accept-Language` only permitted an `es` language response, but such a variant isn't found, then the first variant from the `LANGUAGEPRIORITY` list below will be served.

```
LanguagePriority en fr de
ForceLanguagePriority Fallback
```

Both options, `Prefer` and `Fallback`, may be specified, so either the first matching variant from `LANGUAGEPRIORITY` will be served if more than one variant is acceptable, or first available document will be served if none of the variants matched the client's acceptable list of languages.

See also

- [ADDLANGUAGE](#)

LanguagePriority Directive

Description:	The precedence of language variants for cases where the client does not express a preference
Syntax:	<code>LanguagePriority MIME-lang [MIME-lang] ...</code>
Context:	server config, virtual host, directory, .htaccess
Override:	FileInfo
Status:	Base
Module:	mod_negotiation

The [LANGUAGEPRIORITY](#) sets the precedence of language variants for the case where the client does not express a preference, when handling a MultiViews request. The list of MIME-lang are in order of decreasing preference.

Example:

```
LanguagePriority en fr de
```

For a request for `foo.html`, where `foo.html.fr` and `foo.html.de` both existed, but the browser did not express a language preference, then `foo.html.fr` would be returned.

Note that this directive only has an effect if a 'best' language cannot be determined by any other means or the [FORCE-LANGUAGEPRIORITY](#) directive is not `None`. In general, the client determines the language preference, not the server.

See also

- [ADDLANGUAGE](#)

10.44 Apache Module mod_nw_ssl

Description:	Enable SSL encryption for NetWare
Status:	Base
ModuleIdentifier:	nwssl_module
SourceFile:	mod_nw_ssl.c
Compatibility:	NetWare only

Summary

This module enables SSL encryption for a specified port. It takes advantage of the SSL encryption functionality that is built into the NetWare operating system.

Directives

- NWSSLTrustedCerts
- NWSSLUpgradeable
- SecureListen

NWSSLTrustedCerts Directive

Description:	List of additional client certificates
Syntax:	NWSSLTrustedCerts filename [filename] ...
Context:	server config
Status:	Base
Module:	mod_nw_ssl

Specifies a list of client certificate files (DER format) that are used when creating a proxied SSL connection. Each client certificate used by a server must be listed separately in its own `.der` file.

NWSSLUpgradeable Directive

Description:	Allows a connection to be upgraded to an SSL connection upon request
Syntax:	NWSSLUpgradeable [IP-address:]portnumber
Context:	server config
Status:	Base
Module:	mod_nw_ssl

Allow a connection that was created on the specified address and/or port to be upgraded to an SSL connection upon request from the client. The address and/or port must have already be defined previously with a [LISTEN](#) directive.

SecureListen Directive

Description:	Enables SSL encryption for the specified port
Syntax:	SecureListen [IP-address:]portnumber Certificate-Name [MUTUAL]
Context:	server config
Status:	Base
Module:	mod_nw_ssl

Specifies the port and the eDirectory based certificate name that will be used to enable SSL encryption. An optional third parameter also enables mutual authentication.

10.45 Apache Module mod_proxy

Description:	HTTP/1.1 proxy/gateway server
Status:	Extension
ModuleIdentifier:	proxy_module
SourceFile:	mod_proxy.c

Summary



Warning

Do not enable proxying with [PROXYREQUESTS](#) until you have secured your server. Open proxy servers are dangerous both to your network and to the Internet at large.

This module implements a proxy/gateway for Apache. It implements proxying capability for FTP, CONNECT (for SSL), HTTP/0.9, HTTP/1.0, and HTTP/1.1. The module can be configured to connect to other proxy modules for these and other protocols.

Apache's proxy features are divided into several modules in addition to [MOD_PROXY](#): [MOD_PROXY_HTTP](#), [MOD_PROXY_FTP](#) and [MOD_PROXY_CONNECT](#). Thus, if you want to use one or more of the particular proxy functions, load [MOD_PROXY](#) and the appropriate module(s) into the server (either statically at compile-time or dynamically via the [LOADMODULE](#) directive).

In addition, extended features are provided by other modules. Caching is provided by [MOD_CACHE](#) and related modules. The ability to contact remote servers using the SSL/TLS protocol is provided by the [SSLProxy*](#) directives of [MOD_SSL](#). These additional modules will need to be loaded and configured to take advantage of these features.

Directives

- AllowCONNECT
- NoProxy
- <Proxy>
- ProxyBadHeader
- ProxyBlock
- ProxyDomain
- ProxyErrorOverride
- ProxyFtpDirCharset
- ProxyIOBufferSize
- <ProxyMatch>
- ProxyMaxForwards
- ProxyPass
- ProxyPassReverse
- ProxyPreserveHost
- ProxyReceiveBufferSize
- ProxyRemote
- ProxyRemoteMatch
- ProxyRequests
- ProxyTimeout

- [ProxyVia](#)

See also

- [MOD_CACHE](#)
- [MOD_PROXY_HTTP](#)
- [MOD_PROXY_FTP](#)
- [MOD_PROXY_CONNECT](#)
- [MOD_SSL](#)

Forward and Reverse Proxies

Apache can be configured in both a forward and reverse proxy mode.

An ordinary forward proxy is an intermediate server that sits between the client and the *origin server*. In order to get content from the origin server, the client sends a request to the proxy naming the origin server as the target and the proxy then requests the content from the origin server and returns it to the client. The client must be specially configured to use the forward proxy to access other sites.

A typical usage of a forward proxy is to provide Internet access to internal clients that are otherwise restricted by a firewall. The forward proxy can also use caching (as provided by [MOD_CACHE](#)) to reduce network usage.

The forward proxy is activated using the [PROXYREQUESTS](#) directive. Because forward proxies allow clients to access arbitrary sites through your server and to hide their true origin, it is essential that you secure your server so that only authorized clients can access the proxy before activating a forward proxy.

A reverse proxy, by contrast, appears to the client just like an ordinary web server. No special configuration on the client is necessary. The client makes ordinary requests for content in the name-space of the reverse proxy. The reverse proxy then decides where to send those requests, and returns the content as if it was itself the origin.

A typical usage of a reverse proxy is to provide Internet users access to a server that is behind a firewall. Reverse proxies can also be used to balance load among several back-end servers, or to provide caching for a slower back-end server. In addition, reverse proxies can be used simply to bring several servers into the same URL space.

A reverse proxy is activated using the [PROXYPASS](#) directive or the [P] flag to the [REWRITERULE](#) directive. It is **not** necessary to turn [PROXYREQUESTS](#) on in order to configure a reverse proxy.

Basic Examples

The examples below are only a very basic idea to help you get started. Please read the documentation on the individual directives.

In addition, if you wish to have caching enabled, consult the documentation from [MOD_CACHE](#).

Forward Proxy

```
ProxyRequests On
ProxyVia On
<Proxy *>
    Order deny,allow
    Deny from all
    Allow from internal.example.com
</Proxy>
```

```

Reverse Proxy
ProxyRequests Off
<Proxy *>
    Order deny,allow
    Allow from all
</Proxy>
ProxyPass /foo http://foo.example.com/bar
ProxyPassReverse /foo http://foo.example.com/bar

```

Controlling access to your proxy

You can control who can access your proxy via the `<PROXY>` control block as in the following example:

```

<Proxy *>
    Order Deny,Allow
    Deny from all
    Allow from 192.168.0
</Proxy>

```

For more information on access control directives, see [MOD_ACCESS](#).

Strictly limiting access is essential if you are using a forward proxy (using the `PROXYREQUESTS` directive). Otherwise, your server can be used by any client to access arbitrary hosts while hiding his or her true identity. This is dangerous both for your network and for the Internet at large. When using a reverse proxy (using the `PROXYPASS` directive with `ProxyRequests Off`), access control is less critical because clients can only contact the hosts that you have specifically configured.

FTP Proxy

Why doesn't file type xxx download via FTP?

You probably don't have that particular file type defined as `application/octet-stream` in your proxy's `mime.types` configuration file. A useful line can be

```

application/octet-stream  bin dms lha lzh exe class tgz taz

```

How can I force an FTP ASCII download of File xxx?

In the rare situation where you must download a specific file using the FTP ASCII transfer method (while the default transfer is in binary mode), you can override `MOD_PROXY`'s default by suffixing the request with `;type=a` to force an ASCII transfer. (FTP Directory listings are always executed in ASCII mode, however.)

How can I access FTP files outside of my home directory?

An FTP URI is interpreted relative to the home directory of the user who is logging in. Alas, to reach higher directory levels you cannot use `../`, as the dots are interpreted by the browser and not actually sent to the FTP server. To address this problem, the so called Squid `%2f` hack was implemented in the Apache FTP proxy; it is a solution which is also used by other popular proxy servers like the Squid Proxy Cache²⁵. By prepending `/%2f` to the path of your request,

²⁵<http://www.squid-cache.org/>

you can make such a proxy change the FTP starting directory to / (instead of the home directory). For example, to retrieve the file `/etc/motd`, you would use the URL:

```
ftp://user@host/%2f/etc/motd
```

How can I hide the FTP cleartext password in my browser's URL line?

To log in to an FTP server by username and password, Apache uses different strategies. In absence of a user name and password in the URL altogether, Apache sends an anonymous login to the FTP server, *i.e.*,

```
user: anonymous
password: apache_proxy@
```

This works for all popular FTP servers which are configured for anonymous access.

For a personal login with a specific username, you can embed the user name into the URL, like in:

```
ftp://username@host/myfile
```

If the FTP server asks for a password when given this username (which it should), then Apache will reply with a 401 (Authorization required) response, which causes the Browser to pop up the username/password dialog. Upon entering the password, the connection attempt is retried, and if successful, the requested resource is presented. The advantage of this procedure is that your browser does not display the password in cleartext (which it would if you had used

```
ftp://username:password@host/myfile
```

in the first place).

⇒ Note

The password which is transmitted in such a way is not encrypted on its way. It travels between your browser and the Apache proxy server in a base64-encoded cleartext string, and between the Apache proxy and the FTP server as plaintext. You should therefore think twice before accessing your FTP server via HTTP (or before accessing your personal files via FTP at all!) When using unsecure channels, an eavesdropper might intercept your password on its way.

Slow Startup

If you're using the [PROXYBLOCK](#) directive, hostnames' IP addresses are looked up and cached during startup for later match test. This may take a few seconds (or more) depending on the speed with which the hostname lookups occur.

Intranet Proxy

An Apache proxy server situated in an intranet needs to forward external requests through the company's firewall (for this, configure the [PROXYREMOTE](#) directive to forward the respective scheme to the firewall proxy). However, when it has to access resources within the intranet, it can bypass the firewall when accessing hosts. The [NOPROXY](#) directive is useful for specifying which hosts belong to the intranet and should be accessed directly.

Users within an intranet tend to omit the local domain name from their WWW requests, thus requesting "`http://somehost/`" instead of `http://somehost.example.com/`. Some commercial proxy servers let them

get away with this and simply serve the request, implying a configured local domain. When the [PROXYDOMAIN](#) directive is used and the server is configured for proxy service, Apache can return a redirect response and send the client to the correct, fully qualified, server address. This is the preferred method since the user's bookmark files will then contain fully qualified hosts.

Protocol Adjustments

For circumstances where you have an application server which doesn't implement keepalives or HTTP/1.1 properly, there are 2 environment variables which when set send a HTTP/1.0 with no keepalive. These are set via the [SETENV](#) directive.

These are the `force-proxy-request-1.0` and `proxy-nokeepalive` notes.

```
<Location /buggyappserver/>
  ProxyPass http://buggyappserver:7001/foo/
  SetEnv force-proxy-request-1.0 1
  SetEnv proxy-nokeepalive 1
</Location>
```

AllowCONNECT Directive

Description:	Ports that are allowed to <code>CONNECT</code> through the proxy
Syntax:	<code>AllowCONNECT port [port] ...</code>
Default:	<code>AllowCONNECT 443 563</code>
Context:	server config, virtual host
Status:	Extension
Module:	<code>mod_proxy</code>

The [ALLOWCONNECT](#) directive specifies a list of port numbers to which the proxy `CONNECT` method may connect. Today's browsers use this method when a `https` connection is requested and proxy tunneling over HTTP is in effect.

By default, only the default `https` port (443) and the default `snews` port (563) are enabled. Use the [ALLOWCONNECT](#) directive to override this default and allow connections to the listed ports only.

Note that you'll need to have [MOD_PROXY_CONNECT](#) present in the server in order to get the support for the `CONNECT` at all.

NoProxy Directive

Description:	Hosts, domains, or networks that will be connected to directly
Syntax:	<code>NoProxy host [host] ...</code>
Context:	server config, virtual host
Status:	Extension
Module:	<code>mod_proxy</code>

This directive is only useful for Apache proxy servers within intranets. The [NOPROXY](#) directive specifies a list of subnets, IP addresses, hosts and/or domains, separated by spaces. A request to a host which matches one or more of these is always served directly, without forwarding to the configured [PROXYREMOTE](#) proxy server(s).

Example

```
ProxyRemote * http://firewall.mycompany.com:81
NoProxy .mycompany.com 192.168.112.0/21
```

The host arguments to the `NOPROXY` directive are one of the following type list:

Domain A Domain is a partially qualified DNS domain name, preceded by a period. It represents a list of hosts which logically belong to the same DNS domain or zone (*i.e.*, the suffixes of the hostnames are all ending in Domain).

Examples

`.com .apache.org.`

To distinguish Domains from Hostnames (both syntactically and semantically; a DNS domain can have a DNS A record, too!), Domains are always written with a leading period.

⇒ **Note**

Domain name comparisons are done without regard to the case, and Domains are always assumed to be anchored in the root of the DNS tree, therefore two domains `.MyDomain.com` and `.mydomain.com.` (note the trailing period) are considered equal. Since a domain comparison does not involve a DNS lookup, it is much more efficient than subnet comparison.

SubNet A SubNet is a partially qualified internet address in numeric (dotted quad) form, optionally followed by a slash and the netmask, specified as the number of significant bits in the SubNet. It is used to represent a subnet of hosts which can be reached over a common network interface. In the absence of the explicit net mask it is assumed that omitted (or zero valued) trailing digits specify the mask. (In this case, the netmask can only be multiples of 8 bits wide.) Examples:

192.168 or 192.168.0.0 the subnet 192.168.0.0 with an implied netmask of 16 valid bits (sometimes used in the netmask form 255.255.0.0)

192.168.112.0/21 the subnet 192.168.112.0/21 with a netmask of 21 valid bits (also used in the form 255.255.248.0)

As a degenerate case, a *SubNet* with 32 valid bits is the equivalent to an IPAddr, while a SubNet with zero valid bits (*e.g.*, 0.0.0.0/0) is the same as the constant `_Default_`, matching any IP address.

IPAddr A IPAddr represents a fully qualified internet address in numeric (dotted quad) form. Usually, this address represents a host, but there need not necessarily be a DNS domain name connected with the address.

Example

`192.168.123.7`

⇒ **Note**

An IPAddr does not need to be resolved by the DNS system, so it can result in more effective apache performance.

Hostname A Hostname is a fully qualified DNS domain name which can be resolved to one or more IPAddrs via the DNS domain name service. It represents a logical host (in contrast to Domains, see above) and must be resolvable to at least one IPAddr (or often to a list of hosts with different IPAddrs).

Examples

`prep.ai.mit.edu`
`www.apache.org`

⇒ Note

In many situations, it is more effective to specify an IPAddr in place of a Hostname since a DNS lookup can be avoided. Name resolution in Apache can take a remarkable deal of time when the connection to the name server uses a slow PPP link.

Hostname comparisons are done without regard to the case, and Hostnames are always assumed to be anchored in the root of the DNS tree, therefore two hosts `WWW.MyDomain.com` and `www.mydomain.com.` (note the trailing period) are considered equal.

See also

- DNS Issues (p. 136)

Proxy Directive

Description:	Container for directives applied to proxied resources
Syntax:	<code><Proxy wildcard-url> ...</Proxy></code>
Context:	server config, virtual host
Status:	Extension
Module:	<code>mod_proxy</code>

Directives placed in `<PROXY>` sections apply only to matching proxied content. Shell-style wildcards are allowed.

For example, the following will allow only hosts in `yournetwork.example.com` to access content via your proxy server:

```
<Proxy *>
  Order Deny,Allow
  Deny from all
  Allow from yournetwork.example.com
</Proxy>
```

The following example will process all files in the `foo` directory of `example.com` through the `INCLUDES` filter when they are sent through the proxy server:

```
<Proxy http://example.com/foo/*>
  SetOutputFilter INCLUDES
</Proxy>
```

ProxyBadHeader Directive

Description:	Determines how to handle bad header lines in a response
Syntax:	<code>ProxyBadHeader IsError Ignore StartBody</code>
Default:	<code>ProxyBadHeader IsError</code>
Context:	server config, virtual host
Status:	Extension
Module:	<code>mod_proxy</code>
Compatibility:	Available in Apache 2.0.44 and later

The `PROXYBADHEADER` directive determines the behaviour of `MOD_PROXY` if it receives syntactically invalid header lines (*i.e.* containing no colon). The following arguments are possible:

IsError Abort the request and end up with a 502 (Bad Gateway) response. This is the default behaviour.

Ignore Treat bad header lines as if they weren't sent.

StartBody When receiving the first bad header line, finish reading the headers and treat the remainder as body. This helps to work around buggy backend servers which forget to insert an empty line between the headers and the body.

ProxyBlock Directive

Description:	Words, hosts, or domains that are banned from being proxied
Syntax:	<code>ProxyBlock * word host domain [word host domain] ...</code>
Context:	server config, virtual host
Status:	Extension
Module:	<code>mod_proxy</code>

The **PROXYBLOCK** directive specifies a list of words, hosts and/or domains, separated by spaces. HTTP, HTTPS, and FTP document requests to sites whose names contain matched words, hosts or domains are *blocked* by the proxy server. The proxy module will also attempt to determine IP addresses of list items which may be hostnames during startup, and cache them for match test as well. That may slow down the startup time of the server.

Example

```
ProxyBlock joes-garage.com some-host.co.uk rocky.wotsamattau.edu
```

`rocky.wotsamattau.edu` would also be matched if referenced by IP address.

Note that `wotsamattau` would also be sufficient to match `wotsamattau.edu`.

Note also that

```
ProxyBlock *
```

blocks connections to all sites.

ProxyDomain Directive

Description:	Default domain name for proxied requests
Syntax:	<code>ProxyDomain Domain</code>
Context:	server config, virtual host
Status:	Extension
Module:	<code>mod_proxy</code>

This directive is only useful for Apache proxy servers within intranets. The **PROXYDOMAIN** directive specifies the default domain which the apache proxy server will belong to. If a request to a host without a domain name is encountered, a redirection response to the same host with the configured Domain appended will be generated.

Example

```
ProxyRemote * http://firewall.mycompany.com:81
NoProxy .mycompany.com 192.168.112.0/21
ProxyDomain .mycompany.com
```

ProxyErrorOverride Directive

Description:	Override error pages for proxied content
Syntax:	<code>ProxyErrorOverride On Off</code>
Default:	<code>ProxyErrorOverride Off</code>
Context:	server config, virtual host
Status:	Extension
Module:	<code>mod_proxy</code>
Compatibility:	Available in version 2.0 and later

This directive is useful for reverse-proxy setups, where you want to have a common look and feel on the error pages seen by the end user. This also allows for included files (via `mod_include`'s SSI) to get the error code and act accordingly (default behavior would display the error page of the proxied server, turning this on shows the SSI Error message).

ProxyFtpDirCharset Directive

Description:	Define the character set for proxied FTP listings
Syntax:	<code>ProxyFtpDirCharset character set</code>
Default:	<code>ProxyFtpDirCharset ISO-8859-1</code>
Context:	server config, virtual host, directory
Status:	Extension
Module:	<code>mod_proxy</code>
Compatibility:	Available in Apache 2.0.62 and later

The [PROXYFTPDIRCHARSET](#) directive defines the character set to be set for FTP directory listings in HTML generated by [MOD_PROXY_FTP](#).

ProxyIOBufferSize Directive

Description:	Determine size of internal data throughput buffer
Syntax:	<code>ProxyIOBufferSize bytes</code>
Default:	<code>ProxyIOBufferSize 8192</code>
Context:	server config, virtual host
Status:	Extension
Module:	<code>mod_proxy</code>

The [PROXYIOBUFFERSIZE](#) directive adjusts the size of the internal buffer, which is used as a scratchpad for the data between input and output. The size must be less or equal 8192.

In almost every case there's no reason to change that value.

ProxyMatch Directive

Description:	Container for directives applied to regular-expression-matched proxied resources
Syntax:	<code><ProxyMatch regex> ...</ProxyMatch></code>
Context:	server config, virtual host
Status:	Extension
Module:	<code>mod_proxy</code>

The [<PROXYMATCH>](#) directive is identical to the [<PROXY>](#) directive, except it matches URLs using regular expressions.

ProxyMaxForwards Directive

Description:	Maximum number of proxies that a request can be forwarded through
Syntax:	ProxyMaxForwards number
Default:	ProxyMaxForwards 10
Context:	server config, virtual host
Status:	Extension
Module:	mod_proxy
Compatibility:	Available in Apache 2.0 and later

The [PROXYMAXFORWARDS](#) directive specifies the maximum number of proxies through which a request may pass, if there's no `Max-Forwards` header supplied with the request. This is set to prevent infinite proxy loops, or a DoS attack.

Example

```
ProxyMaxForwards 15
```

ProxyPass Directive

Description:	Maps remote servers into the local server URL-space
Syntax:	ProxyPass [path] ! url
Context:	server config, virtual host, directory
Status:	Extension
Module:	mod_proxy

This directive allows remote servers to be mapped into the space of the local server; the local server does not act as a proxy in the conventional sense, but appears to be a mirror of the remote server. `path` is the name of a local virtual path; `url` is a partial URL for the remote server and cannot include a query string.

Suppose the local server has address `http://example.com/`; then

```
ProxyPass /mirror/foo/ http://backend.example.com/
```

will cause a local request for `http://example.com/mirror/foo/bar` to be internally converted into a proxy request to `http://backend.example.com/bar`.

The `!` directive is useful in situations where you don't want to reverse-proxy a subdirectory, *e.g.*

```
ProxyPass /mirror/foo/i !
ProxyPass /mirror/foo http://backend.example.com
```

will proxy all requests to `/mirror/foo` to `backend.example.com` *except* requests made to `/mirror/foo/i`.

⇒ Note

Order is important. you need to put the exclusions *before* the general proxypass directive.

When used inside a `<LOCATION>` section, the first argument is omitted and the local directory is obtained from the `<LOCATION>`.



The [PROXYREQUESTS](#) directive should usually be set **off** when using [PROXYPASS](#).

If you require a more flexible reverse-proxy configuration, see the [REWRITERULE](#) directive with the `[P]` flag.

ProxyPassReverse Directive

Description:	Adjusts the URL in HTTP response headers sent from a reverse proxied server
Syntax:	<code>ProxyPassReverse [path] url</code>
Context:	server config, virtual host, directory
Status:	Extension
Module:	<code>mod_proxy</code>

This directive lets Apache adjust the URL in the `Location`, `Content-Location` and `URI` headers on HTTP redirect responses. This is essential when Apache is used as a reverse proxy to avoid by-passing the reverse proxy because of HTTP redirects on the backend servers which stay behind the reverse proxy.

Only the HTTP response headers specifically mentioned above will be rewritten. Apache will not rewrite other response headers, nor will it rewrite URL references inside HTML pages. This means that if the proxied content contains absolute URL references, they will by-pass the proxy. A third-party module that will look inside the HTML and rewrite URL references is Nick Kew's `mod_proxy_html`²⁶.

`path` is the name of a local virtual path. `url` is a partial URL for the remote server - the same way they are used for the `PROXYPASS` directive.

For example, suppose the local server has address `http://example.com/`; then

```
ProxyPass /mirror/foo/ http://backend.example.com/
ProxyPassReverse /mirror/foo/ http://backend.example.com/
```

will not only cause a local request for the `http://example.com/mirror/foo/bar` to be internally converted into a proxy request to `http://backend.example.com/bar` (the functionality `ProxyPass` provides here). It also takes care of redirects the server `backend.example.com` sends: when `http://backend.example.com/bar` is redirected by him to `http://backend.example.com/quux` Apache adjusts this to `http://example.com/mirror/foo/quux` before forwarding the HTTP redirect response to the client. Note that the hostname used for constructing the URL is chosen in respect to the setting of the `USECANONICALNAME` directive.

Note that this `PROXYPASSREVERSE` directive can also be used in conjunction with the proxy pass-through feature (`RewriteRule ... [P]`) from `MOD_REWRITE` because its doesn't depend on a corresponding `PROXYPASS` directive.

When used inside a `<LOCATION>` section, the first argument is omitted and the local directory is obtained from the `<LOCATION>`.

ProxyPreserveHost Directive

Description:	Use incoming Host HTTP request header for proxy request
Syntax:	<code>ProxyPreserveHost On Off</code>
Default:	<code>ProxyPreserveHost Off</code>
Context:	server config, virtual host
Status:	Extension
Module:	<code>mod_proxy</code>
Compatibility:	Available in Apache 2.0.31 and later.

When enabled, this option will pass the `Host:` line from the incoming request to the proxied host, instead of the hostname specified in the `proxypass` line.

This option should normally be turned `Off`. It is mostly useful in special configurations like proxied mass name-based virtual hosting, where the original `Host` header needs to be evaluated by the backend server.

²⁶http://www.webthing.com/software/mod_proxy.html/

ProxyReceiveBufferSize Directive

Description:	Network buffer size for proxied HTTP and FTP connections
Syntax:	<code>ProxyReceiveBufferSize bytes</code>
Default:	<code>ProxyReceiveBufferSize 0</code>
Context:	server config, virtual host
Status:	Extension
Module:	<code>mod_proxy</code>

The [PROXYRECEIVEBUFFERSIZE](#) directive specifies an explicit (TCP/IP) network buffer size for proxied HTTP and FTP connections, for increased throughput. It has to be greater than 512 or set to 0 to indicate that the system's default buffer size should be used.

Example

```
ProxyReceiveBufferSize 2048
```

ProxyRemote Directive

Description:	Remote proxy used to handle certain requests
Syntax:	<code>ProxyRemote match remote-server</code>
Context:	server config, virtual host
Status:	Extension
Module:	<code>mod_proxy</code>

This defines remote proxies to this proxy. `match` is either the name of a URL-scheme that the remote server supports, or a partial URL for which the remote server should be used, or `*` to indicate the server should be contacted for all requests. `remote-server` is a partial URL for the remote server. Syntax:

```
remote-server = scheme://hostname[:port]
```

`scheme` is effectively the protocol that should be used to communicate with the remote server; only `http` is supported by this module.

Example

```
ProxyRemote http://goodguys.com/ http://mirrorguys.com:8000
ProxyRemote * http://cleversite.com
ProxyRemote ftp http://ftpproxy.mydomain.com:8080
```

In the last example, the proxy will forward FTP requests, encapsulated as yet another HTTP proxy request, to another proxy which can handle them.

This option also supports reverse proxy configuration - a backend webserver can be embedded within a virtualhost URL space even if that server is hidden by another forward proxy.

ProxyRemoteMatch Directive

Description:	Remote proxy used to handle requests matched by regular expressions
Syntax:	<code>ProxyRemoteMatch regex remote-server</code>
Context:	server config, virtual host
Status:	Extension
Module:	<code>mod_proxy</code>

The `PROXYREMOTE` is identical to the `PROXYREMOTE` directive, except the first argument is a regular expression match against the requested URL.

ProxyRequests Directive

Description:	Enables forward (standard) proxy requests
Syntax:	<code>ProxyRequests On Off</code>
Default:	<code>ProxyRequests Off</code>
Context:	server config, virtual host
Status:	Extension
Module:	<code>mod_proxy</code>

This allows or prevents Apache from functioning as a forward proxy server. (Setting `ProxyRequests` to `Off` does not disable use of the `PROXYPASS` directive.)

In a typical reverse proxy configuration, this option should be set to `Off`.

In order to get the functionality of proxying HTTP or FTP sites, you need also `MOD_PROXY_HTTP` or `MOD_PROXY_FTP` (or both) present in the server.



Warning

Do not enable proxying with `PROXYREQUESTS` until you have secured your server. Open proxy servers are dangerous both to your network and to the Internet at large.

ProxyTimeout Directive

Description:	Network timeout for proxied requests
Syntax:	<code>ProxyTimeout seconds</code>
Default:	<code>ProxyTimeout 300</code>
Context:	server config, virtual host
Status:	Extension
Module:	<code>mod_proxy</code>
Compatibility:	Available in Apache 2.0.31 and later

This directive allows a user to specify a timeout on proxy requests. This is useful when you have a slow/buggy appserver which hangs, and you would rather just return a timeout and fail gracefully instead of waiting however long it takes the server to return.

ProxyVia Directive

Description:	Information provided in the <code>Via</code> HTTP response header for proxied requests
Syntax:	<code>ProxyVia On Off Full Block</code>
Default:	<code>ProxyVia Off</code>
Context:	server config, virtual host
Status:	Extension
Module:	<code>mod_proxy</code>

This directive controls the use of the `Via: HTTP` header by the proxy. Its intended use is to control the flow of proxy requests along a chain of proxy servers. See RFC 2616²⁷ (HTTP/1.1), section 14.45 for an explanation of `Via:` header lines.

²⁷<http://www.ietf.org/rfc/rfc2616.txt>

- If set to `Off`, which is the default, no special processing is performed. If a request or reply contains a `Via:` header, it is passed through unchanged.
- If set to `On`, each request and reply will get a `Via:` header line added for the current host.
- If set to `Full`, each generated `Via:` header line will additionally have the Apache server version shown as a `Via: comment` field.
- If set to `Block`, every proxy request will have all its `Via:` header lines removed. No new `Via:` header will be generated.

10.46 Apache Module `mod_proxy_connect`

Description:	MOD_PROXY extension for <code>CONNECT</code> request handling
Status:	Extension
ModuleIdentifier:	<code>proxy_connect_module</code>
SourceFile:	<code>proxy_connect.c</code>

Summary

This module *requires* the service of [MOD_PROXY](#). It provides support for the `CONNECT` HTTP method. This method is mainly used to tunnel SSL requests through proxy servers.

Thus, in order to get the ability of handling `CONNECT` requests, [MOD_PROXY](#) and [MOD_PROXY_CONNECT](#) have to be present in the server.



Warning

Do not enable proxying until you have secured your server (p. 504) . Open proxy servers are dangerous both to your network and to the Internet at large.

Directives This module provides no directives.

See also

- [ALLOWCONNECT](#)
- [MOD_PROXY](#)

10.47 Apache Module mod_proxy_ftp

Description:	FTP support module for MOD_PROXY
Status:	Extension
ModuleIdentifier:	proxy_ftp_module
SourceFile:	proxy_ftp.c

Summary

This module *requires* the service of [MOD_PROXY](#). It provides support for the proxying FTP sites.

Thus, in order to get the ability of handling FTP proxy requests, [MOD_PROXY](#) and [MOD_PROXY_FTP](#) have to be present in the server.



Warning

Do not enable proxying until you have secured your server (p. [504](#)) . Open proxy servers are dangerous both to your network and to the Internet at large.

Directives This module provides no directives.

See also

- [MOD_PROXY](#)

10.48 Apache Module `mod_proxy_http`

Description:	HTTP support module for MOD_PROXY
Status:	Extension
ModuleIdentifier:	<code>proxy_http_module</code>
SourceFile:	<code>proxy_http.c</code>

Summary

This module *requires* the service of [MOD_PROXY](#). It provides the features used for proxying HTTP requests. [MOD_PROXY_HTTP](#) supports HTTP/0.9, HTTP/1.0 and HTTP/1.1. It does *not* provide any caching abilities. If you want to set up a caching proxy, you might want to use the additional service of the [MOD_CACHE](#) module.

Thus, in order to get the ability of handling HTTP proxy requests, [MOD_PROXY](#) and [MOD_PROXY_HTTP](#) have to be present in the server.



Warning

Do not enable proxying until you have secured your server (p. [504](#)) . Open proxy servers are dangerous both to your network and to the Internet at large.

Directives This module provides no directives.

See also

- [MOD_PROXY](#)
- [MOD_PROXY_CONNECT](#)

10.49 Apache Module mod_rewrite

Description:	Provides a rule-based rewriting engine to rewrite requested URLs on the fly
Status:	Extension
ModuleIdentifier:	rewrite_module
SourceFile:	mod_rewrite.c
Compatibility:	Available in Apache 1.3 and later

Summary

This module uses a rule-based rewriting engine (based on a regular-expression parser) to rewrite requested URLs on the fly. It supports an unlimited number of rules and an unlimited number of attached rule conditions for each rule, to provide a really flexible and powerful URL manipulation mechanism. The URL manipulations can depend on various tests, of server variables, environment variables, HTTP headers, or time stamps. Even external database lookups in various formats can be used to achieve highly granular URL matching.

This module operates on the full URLs (including the path-info part) both in per-server context (`httpd.conf`) and per-directory context (`.htaccess`) and can generate query-string parts on result. The rewritten result can lead to internal sub-processing, external request redirection or even to an internal proxy throughput.

Further details, discussion, and examples, are provided in the detailed `mod_rewrite` documentation (p. ??).

Directives

- RewriteBase
- RewriteCond
- RewriteEngine
- RewriteLock
- RewriteLog
- RewriteLogLevel
- RewriteMap
- RewriteOptions
- RewriteRule

API Phases

Apache processes a HTTP request in several phases. A hook for each of these phases is provided by the Apache API. `MOD_REWRITE` uses two of these hooks: the URL-to-filename translation hook (used after the HTTP request has been read, but before any authorization starts) and the Fixup hook (triggered after the authorization phases, and after the per-directory config files (`.htaccess`) have been read, but before the content handler is activated).

Once a request comes in, and Apache has determined the appropriate server (or virtual server), the rewrite engine starts the URL-to-filename translation, processing the `mod_rewrite` directives from the per-server configuration. A few steps later, when the final data directories are found, the per-directory configuration directives of `mod_rewrite` are triggered in the Fixup phase.

Ruleset Processing

When `mod_rewrite` is triggered during these two API phases, it reads the relevant rulesets from its configuration structure (which was either created on startup, for per-server context, or during the directory traversal for per-directory

context). The URL rewriting engine is started with the appropriate ruleset (one or more rules together with their conditions), and its operation is exactly the same for both configuration contexts. Only the final result processing is different.

The order of rules in the ruleset is important because the rewrite engine processes them in a particular (not always obvious) order, as follows: The rewrite engine loops through the rulesets (each ruleset being made up of `REWRITERULE` directives, with or without `REWRITECONDS`), rule by rule. When a particular rule is matched, `MOD_REWRITE` also checks the corresponding conditions (`RewriteCond` directives). For historical reasons the conditions are given first, making the control flow a little bit long-winded. See Figure 1 for more details.

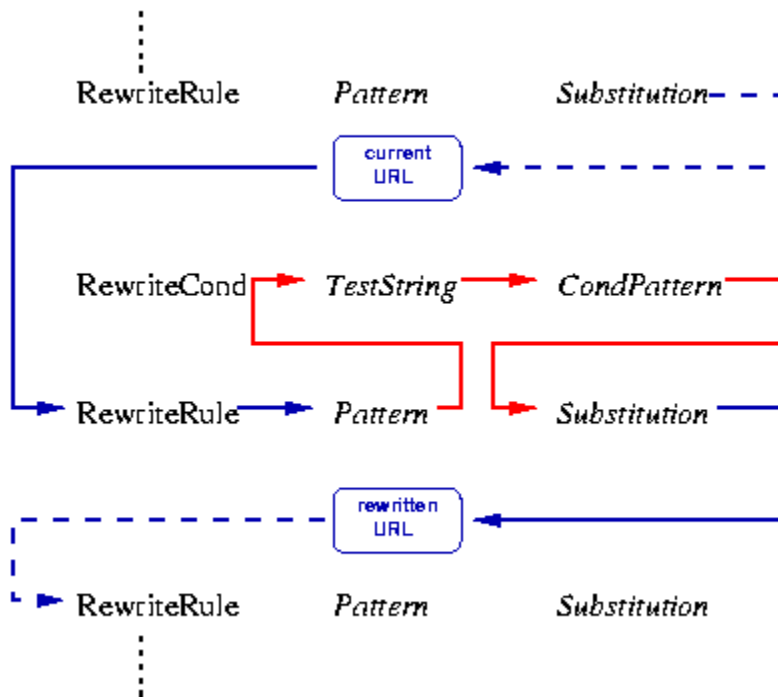

Figure 1: The control flow of the rewrite engine through a rewrite ruleset

As above, first the URL is matched against the *Pattern* of a rule. If it does not match, `MOD_REWRITE` immediately stops processing that rule, and goes on to the next rule. If the *Pattern* matches, `MOD_REWRITE` checks for rule conditions. If none are present, the URL will be replaced with a new string, constructed from the *Substitution* string, and `MOD_REWRITE` goes on to the next rule.

If `REWRITECONDS` exist, an inner loop is started, processing them in the order that they are listed. Conditions are not matched against the current URL directly. A *TestString* is constructed by expanding variables, back-references, map lookups, etc., against which the *CondPattern* is matched. If the pattern fails to match one of the conditions, the complete set of rule and associated conditions fails. If the pattern matches a given condition, then matching continues to the next condition, until no more conditions are available. If all conditions match, processing is continued with the substitution of the *Substitution* string for the URL.

Regex Back-Reference Availability

Using parentheses in *Pattern* or in one of the *CondPatterns* causes back-references to be internally created. These can later be referenced using the strings `$N` and `%N` (see below), for creating the *Substitution* and *TestString* strings. Figure 2 attempts to show how the back-references are transferred through the process for later expansion.

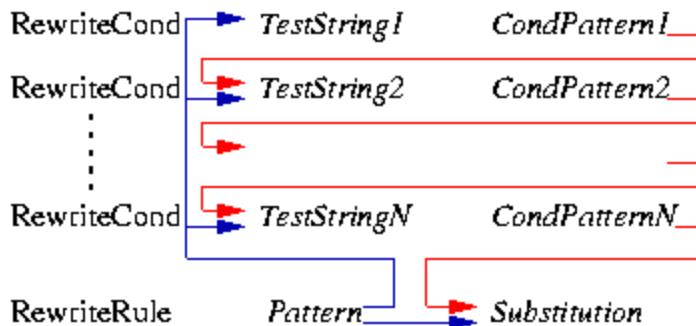

Figure 2: The back-reference flow through a rule.

Quoting Special Characters

As of Apache 1.3.20, special characters in *TestString* and *Substitution* strings can be escaped (that is, treated as normal characters without their usual special meaning) by prefixing them with a slash (`'\'`) character. In other words, you can include an actual dollar-sign character in a *Substitution* string by using `'\$'`; this keeps `mod_rewrite` from trying to treat it as a backreference.

Environment Variables

This module keeps track of two additional (non-standard) CGI/SSI environment variables named `SCRIPT_URL` and `SCRIPT_URI`. These contain the *logical* Web-view to the current resource, while the standard CGI/SSI variables `SCRIPT_NAME` and `SCRIPT_FILENAME` contain the *physical* System-view.

Notice: These variables hold the URI/URL *as they were initially requested*, that is, *before* any rewriting. This is important to note because the rewriting process is primarily used to rewrite logical URLs to physical pathnames.

Example

```
SCRIPT_NAME=/sw/lib/w3s/tree/global/u/rse/.www/index.html
SCRIPT_FILENAME=/u/rse/.www/index.html
SCRIPT_URL=/u/rse/
SCRIPT_URI=http://en1.engelschall.com/u/rse/
```

Practical Solutions

For numerous examples of common, and not-so-common, uses for `mod_rewrite`, see the Rewrite Guide (p. ??) , and the Advanced Rewrite Guide (p. ??) documents.

RewriteBase Directive

Description:	Sets the base URL for per-directory rewrites
Syntax:	<code>RewriteBase URL-path</code>
Default:	See usage for information.
Context:	directory, <code>.htaccess</code>
Override:	FileInfo
Status:	Extension
Module:	<code>mod_rewrite</code>

The `REWRITEBASE` directive explicitly sets the base URL for per-directory rewrites. As you will see below, `REWRITERULE` can be used in per-directory config files (`.htaccess`). In such a case, it will act locally, stripping the local directory prefix before processing, and applying rewrite rules only to the remainder. When processing is complete, the prefix is automatically added back to the path. The default setting is; `REWRITEBASE` *physical-directory-path*

When a substitution occurs for a new URL, this module has to re-inject the URL into the server processing. To be able to do this it needs to know what the corresponding URL-prefix or URL-base is. By default this prefix is the corresponding filepath itself. **However, for most websites, URLs are NOT directly related to physical filename paths, so this assumption will often be wrong!** Therefore, you can use the `RewriteBase` directive to specify the correct URL-prefix.

⇒ If your webserver's URLs are **not** directly related to physical file paths, you will need to use `REWRITEBASE` in every `.htaccess` file where you want to use `REWRITERULE` directives.

For example, assume the following per-directory config file:

```
#
# /abc/def/.htaccess -- per-dir config file for directory /abc/def
# Remember: /abc/def is the physical path of /xyz, i.e., the server
#           has a 'Alias /xyz /abc/def' directive e.g.
#

RewriteEngine On

# let the server know that we were reached via /xyz and not
# via the physical path prefix /abc/def
RewriteBase /xyz

# now the rewriting rules
RewriteRule ^oldstuff\.html$ newstuff.html
```

In the above example, a request to `/xyz/oldstuff.html` gets correctly rewritten to the physical file `/abc/def/newstuff.html`.

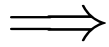

For Apache Hackers

The following list gives detailed information about the internal processing steps:

Request:

```
/xyz/oldstuff.html
```

Internal Processing:

```
/xyz/oldstuff.html    -> /abc/def/oldstuff.html  (per-server Alias)
/abc/def/oldstuff.html -> /abc/def/newstuff.html  (per-dir RewriteRule)
/abc/def/newstuff.html -> /xyz/newstuff.html      (per-dir RewriteBase)
/xyz/newstuff.html    -> /abc/def/newstuff.html  (per-server Alias)
```

Result:

```
/abc/def/newstuff.html
```

This seems very complicated, but is in fact correct Apache internal processing. Because the per-directory rewriting comes late in the process, the rewritten request has to be re-injected into the Apache kernel. This is not the serious overhead it may seem to be - this re-injection is completely internal to the Apache server (and the same procedure is used by many other operations within Apache).

RewriteCond Directive

Description:	Defines a condition under which rewriting will take place
Syntax:	<code>RewriteCond <i>TestString CondPattern</i></code>
Context:	server config, virtual host, directory, .htaccess
Override:	FileInfo
Status:	Extension
Module:	mod_rewrite

The [REWRITECOND](#) directive defines a rule condition. One or more [REWRITECOND](#) can precede a [REWRITERULE](#) directive. The following rule is then only used if both the current state of the URI matches its pattern, **and** if these conditions are met.

TestString is a string which can contain the following expanded constructs in addition to plain text:

- **RewriteRule backreferences:** These are backreferences of the form `$N` ($0 \leq N \leq 9$), which provide access to the grouped parts (in parentheses) of the pattern, from the `RewriteRule` which is subject to the current set of `RewriteCond` conditions..
- **RewriteCond backreferences:** These are backreferences of the form `%N` ($1 \leq N \leq 9$), which provide access to the grouped parts (again, in parentheses) of the pattern, from the last matched `RewriteCond` in the current set of conditions.
- **RewriteMap expansions:** These are expansions of the form `#{mapname:key|default}`. See the documentation for `RewriteMap` for more details.
- **Server-Variables:** These are variables of the form `%{NAME_OF_VARIABLE}` where `NAME_OF_VARIABLE` can be a string taken from the following list:

HTTP headers:	connection & request:	
HTTP_USER_AGENT	REMOTE_ADDR	
HTTP_REFERER	REMOTE_HOST	
HTTP_COOKIE	REMOTE_PORT	
HTTP_FORWARDED	REMOTE_USER	
HTTP_HOST	REMOTE_IDENT	
HTTP_PROXY_CONNECTION	REQUEST_METHOD	
HTTP_ACCEPT	SCRIPT_FILENAME	
	PATH_INFO	
	QUERY_STRING	
	AUTH_TYPE	
server internals:	system stuff:	specials:
DOCUMENT_ROOT	TIME_YEAR	API_VERSION
SERVER_ADMIN	TIME_MON	THE_REQUEST
SERVER_NAME	TIME_DAY	REQUEST_URI
SERVER_ADDR	TIME_HOUR	REQUEST_FILENAME
SERVER_PORT	TIME_MIN	IS_SUBREQ
SERVER_PROTOCOL	TIME_SEC	HTTPS
SERVER_SOFTWARE	TIME_WDAY	
	TIME	

These variables all correspond to the similarly named HTTP MIME-headers, C variables of the Apache server or `struct tm` fields of the Unix system. Most are documented elsewhere in the Manual or in the CGI specification. Those that are special to `mod_rewrite` include those below.

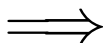

IS_SUBREQ Will contain the text "true" if the request currently being processed is a sub-request, "false" otherwise. Sub-requests may be generated by modules that need to resolve additional files or URIs in order to complete their tasks.

API_VERSION This is the version of the Apache module API (the internal interface between server and module) in the current `httpd` build, as defined in `include/ap_mmn.h`. The module API version corresponds to the version of Apache in use (in the release version of Apache 1.3.14, for instance, it is 19990320:10), but is mainly of interest to module authors.

THE_REQUEST The full HTTP request line sent by the browser to the server (e.g., "GET /index.html HTTP/1.1"). This does not include any additional headers sent by the browser.

REQUEST_URI The resource requested in the HTTP request line. (In the example above, this would be "/index.html".)

REQUEST_FILENAME The full local filesystem path to the file or script matching the request.

HTTPS Will contain the text "on" if the connection is using SSL/TLS, or "off" otherwise. (This variable can be safely used regardless of whether or not `MOD_SSL` is loaded).

Other things you should be aware of:

1. The variables `SCRIPT_FILENAME` and `REQUEST_FILENAME` contain the same value - the value of the `filename` field of the internal `request_rec` structure of the Apache server. The first name is the commonly known CGI variable name while the second is the appropriate counterpart of `REQUEST_URI` (which contains the value of the `uri` field of `request_rec`).
2. `%{ENV:variable}`, where *variable* can be any environment variable, is also available. This is looked-up via internal Apache structures and (if not found there) via `getenv()` from the Apache server process.

3. `%{SSL:variable}`, where *variable* is the name of an SSL environment variable (p. 549), can be used whether or not `MOD_SSL` is loaded, but will always expand to the empty string if it is not. Example: `%{SSL:SSL_CIPHER_USEKEYSIZE}` may expand to `128`.
4. `%{HTTP:header}`, where *header* can be any HTTP MIME-header name, can always be used to obtain the value of a header sent in the HTTP request. Example: `%{HTTP:Proxy-Connection}` is the value of the HTTP header "Proxy-Connection:".
5. `%{LA-U:variable}` can be used for look-aheads which perform an internal (URL-based) sub-request to determine the final value of *variable*. This can be used to access variable for rewriting which is not available at the current stage, but will be set in a later phase. For instance, to rewrite according to the `REMOTE_USER` variable from within the per-server context (`httpd.conf` file) you must use `%{LA-U:REMOTE_USER}` - this variable is set by the authorization phases, which come *after* the URL translation phase (during which `mod_rewrite` operates).
On the other hand, because `mod_rewrite` implements its per-directory context (`.htaccess` file) via the Fixup phase of the API and because the authorization phases come *before* this phase, you just can use `%{REMOTE_USER}` in that context.
6. `%{LA-F:variable}` can be used to perform an internal (filename-based) sub-request, to determine the final value of *variable*. Most of the time, this is the same as `LA-U` above.

CondPattern is the condition pattern, a regular expression which is applied to the current instance of the *TestString*. *TestString* is first evaluated, before being matched against *CondPattern*.

Remember: *CondPattern* is a *perl compatible regular expression* with some additions:

1. You can prefix the pattern string with a '!' character (exclamation mark) to specify a **non**-matching pattern.
2. There are some special variants of *CondPatterns*. Instead of real regular expression strings you can also use one of the following:
 - '**<CondPattern**' (lexicographically precedes)
Treats the *CondPattern* as a plain string and compares it lexicographically to *TestString*. True if *TestString* lexicographically precedes *CondPattern*.
 - '**>CondPattern**' (lexicographically follows)
Treats the *CondPattern* as a plain string and compares it lexicographically to *TestString*. True if *TestString* lexicographically follows *CondPattern*.
 - '**=CondPattern**' (lexicographically equal)
Treats the *CondPattern* as a plain string and compares it lexicographically to *TestString*. True if *TestString* is lexicographically equal to *CondPattern* (the two strings are exactly equal, character for character). If *CondPattern* is "" (two quotation marks) this compares *TestString* to the empty string.
 - '**-d**' (is directory)
Treats the *TestString* as a pathname and tests whether or not it exists, and is a directory.
 - '**-f**' (is regular file)
Treats the *TestString* as a pathname and tests whether or not it exists, and is a regular file.
 - '**-s**' (is regular file, with size)
Treats the *TestString* as a pathname and tests whether or not it exists, and is a regular file with size greater than zero.
 - '**-l**' (is symbolic link)
Treats the *TestString* as a pathname and tests whether or not it exists, and is a symbolic link.
 - '**-F**' (is existing file, via subrequest)
Checks whether or not *TestString* is a valid file, accessible via all the server's currently-configured access controls for that path. This uses an internal subrequest to do the check, so use it with care - it can impact your server's performance!

- **'-U'** (is existing URL, via subrequest)
Checks whether or not *TestString* is a valid URL, accessible via all the server's currently-configured access controls for that path. This uses an internal subrequest to do the check, so use it with care - it can impact your server's performance!

⇒ Note

All of these tests can also be prefixed by an exclamation mark ('!') to negate their meaning.

3. You can also set special flags for *CondPattern* by appending **[flags]** as the third argument to the `RewriteCond` directive, where *flags* is a comma-separated list of any of the following flags:

- **'nocase|NC'** (no case)
This makes the test case-insensitive - differences between 'A-Z' and 'a-z' are ignored, both in the expanded *TestString* and the *CondPattern*. This flag is effective only for comparisons between *TestString* and *CondPattern*. It has no effect on filesystem and subrequest checks.
- **'ornext|OR'** (or next condition)
Use this to combine rule conditions with a local OR instead of the implicit AND. Typical example:

```
RewriteCond %{REMOTE_HOST} ^host1.* [OR]
RewriteCond %{REMOTE_HOST} ^host2.* [OR]
RewriteCond %{REMOTE_HOST} ^host3.*
RewriteRule ...some special stuff for any of these hosts...
```

Without this flag you would have to write the condition/rule pair three times.

Example:

To rewrite the Homepage of a site according to the "User-Agent:" header of the request, you can use the following:

```
RewriteCond %{HTTP_USER_AGENT} ^Mozilla.*
RewriteRule ^/$ /homepage.max.html [L]

RewriteCond %{HTTP_USER_AGENT} ^Lynx.*
RewriteRule ^/$ /homepage.min.html [L]

RewriteRule ^/$ /homepage.std.html [L]
```

Explanation: If you use a browser which identifies itself as 'Mozilla' (including Netscape Navigator, Mozilla etc), then you get the max homepage (which could include frames, or other special features). If you use the Lynx browser (which is terminal-based), then you get the min homepage (which could be a version designed for easy, text-only browsing). If neither of these conditions apply (you use any other browser, or your browser identifies itself as something non-standard), you get the std (standard) homepage.

RewriteEngine Directive

Description:	Enables or disables runtime rewriting engine
Syntax:	<code>RewriteEngine on off</code>
Default:	<code>RewriteEngine off</code>
Context:	server config, virtual host, directory, <code>.htaccess</code>
Override:	FileInfo
Status:	Extension
Module:	<code>mod_rewrite</code>

The `REWRITEENGINE` directive enables or disables the runtime rewriting engine. If it is set to `off` this module does no runtime processing at all. It does not even update the `SCRIPT_URx` environment variables.

Use this directive to disable the module instead of commenting out all the `REWRITERULE` directives!

Note that, by default, rewrite configurations are not inherited. This means that you need to have a `RewriteEngine on` directive for each virtual host in which you wish to use it.

RewriteLock Directive

Description:	Sets the name of the lock file used for <code>REWRITEMAP</code> synchronization
Syntax:	<code>RewriteLock file-path</code>
Context:	server config
Status:	Extension
Module:	<code>mod_rewrite</code>

This directive sets the filename for a synchronization lockfile which `mod_rewrite` needs to communicate with `REWRITEMAP` programs. Set this lockfile to a local path (not on a NFS-mounted device) when you want to use a rewriting map-program. It is not required for other types of rewriting maps.

RewriteLog Directive

Description:	Sets the name of the file used for logging rewrite engine processing
Syntax:	<code>RewriteLog file-path</code>
Context:	server config, virtual host
Status:	Extension
Module:	<code>mod_rewrite</code>

The `REWRITELOG` directive sets the name of the file to which the server logs any rewriting actions it performs. If the name does not begin with a slash (`/`) then it is assumed to be relative to the *Server Root*. The directive should occur only once per server config.

⇒ To disable the logging of rewriting actions it is not recommended to set *Filename* to `/dev/null`, because although the rewriting engine does not then output to a logfile it still creates the logfile output internally. **This will slow down the server with no advantage to the administrator!** To disable logging either remove or comment out the `REWRITELOG` directive or use `RewriteLogLevel 0`!

⇒ Security

See the Apache Security Tips (p. 40) document for details on how your security could be compromised if the directory where logfiles are stored is writable by anyone other than the user that starts the server.

Example

```
RewriteLog "/usr/local/var/apache/logs/rewrite.log"
```

RewriteLogLevel Directive

Description:	Sets the verbosity of the log file used by the rewrite engine
Syntax:	<code>RewriteLogLevel <i>Level</i></code>
Default:	<code>RewriteLogLevel 0</code>
Context:	server config, virtual host
Status:	Extension
Module:	<code>mod_rewrite</code>

The `REWRITELOGLEVEL` directive sets the verbosity level of the rewriting logfile. The default level 0 means no logging, while 9 or more means that practically all actions are logged.

To disable the logging of rewriting actions simply set *Level* to 0. This disables all rewrite action logs.

⇒ Using a high value for *Level* will slow down your Apache server dramatically! Use the rewriting logfile at a *Level* greater than 2 only for debugging!

Example

```
RewriteLogLevel 3
```

RewriteMap Directive

Description:	Defines a mapping function for key-lookup
Syntax:	<code>RewriteMap <i>MapName MapType:MapSource</i></code>
Context:	server config, virtual host
Status:	Extension
Module:	<code>mod_rewrite</code>
Compatibility:	The choice of different dbm types is available in Apache 2.0.41 and later

The `REWRITEMAP` directive defines a *Rewriting Map* which can be used inside rule substitution strings by the mapping-functions to insert/substitute fields through a key lookup. The source of this lookup can be of various types.

The *MapName* is the name of the map and will be used to specify a mapping-function for the substitution strings of a rewriting rule via one of the following constructs:

```
#{ MapName : LookupKey }  

#{ MapName : LookupKey | DefaultValue }
```

When such a construct occurs, the map *MapName* is consulted and the key *LookupKey* is looked-up. If the key is found, the map-function construct is substituted by *SubstValue*. If the key is not found then it is substituted by *DefaultValue* or by the empty string if no *DefaultValue* was specified.

For example, you might define a `REWRITEMAP` as:

```
RewriteMap examplemap txt:/path/to/file/map.txt
```

You would then be able to use this map in a `REWRITERULE` as follows:

```
RewriteRule ^/ex/(.*) ${examplemap:$1}
```

The following combinations for *MapType* and *MapSource* can be used:

- **Standard Plain Text**

MapType: `txt`, MapSource: Unix filesystem path to valid regular file

This is the standard rewriting map feature where the *MapSource* is a plain ASCII file containing either blank lines, comment lines (starting with a '#' character) or pairs like the following - one per line.

MatchingKey SubstValue

Example

```
##
## map.txt -- rewriting map
##

Ralf.S.Engelschall    rse    # Bastard Operator From Hell
Mr.Joe.Average       joe    # Mr. Average
```

```
RewriteMap real-to-user txt:/path/to/file/map.txt
```

- **Randomized Plain Text**

MapType: `rnd`, MapSource: Unix filesystem path to valid regular file

This is identical to the Standard Plain Text variant above but with a special post-processing feature: After looking up a value it is parsed according to contained "|" characters which have the meaning of "or". In other words they indicate a set of alternatives from which the actual returned value is chosen randomly. For example, you might use the following map file and directives to provide a random load balancing between several back-end server, via a reverse-proxy. Images are sent to one of the servers in the 'static' pool, while everything else is sent to one of the 'dynamic' pool.

Example:

Rewrite map file

```
##
## map.txt -- rewriting map
##

static    www1|www2|www3|www4
dynamic   www5|www6
```

Configuration directives

```
RewriteMap servers rnd:/path/to/file/map.txt
RewriteRule ^/(.*\.(png|gif|jpg)) http://${servers:static}/$1 [NC,P,L]
RewriteRule ^/(.*) http://${servers:dynamic}/$1 [P,L]
```

- **Hash File**

MapType: `dbm[=type]`, MapSource: Unix filesystem path to valid regular file

Here the source is a binary format DBM file containing the same contents as a *Plain Text* format file, but in a special representation which is optimized for really fast lookups. The *type* can be `sdbm`, `gdbm`, `ndbm`, or `db` depending on compile-time settings (p. 10) . If the *type* is omitted, the compile-time default will be chosen. You can create such a file with any DBM tool or with the following Perl script. Be sure to adjust it to create the appropriate type of DBM. The example creates an NDBM file.

```
#!/path/to/bin/perl
##
## txt2dbm -- convert txt map to dbm format
##

use NDBM_File;
use Fcntl;

($txtmap, $dbmmap) = @ARGV;

open(TXT, "<$txtmap") or die "Couldn't open $txtmap!\n";
tie (%DB, 'NDBM_File', $dbmmap, O_RDWR|O_TRUNC|O_CREAT, 0644)
    or die "Couldn't create $dbmmap!\n";

while (<TXT>) {
    next if (/^\s*#/ or /^\s*$/);
    $DB{$1} = $2 if (/^\s*(\S+)\s+(\S+)/);
}

untie %DB;
close(TXT);
```

```
$ txt2dbm map.txt map.db
```

- **Internal Function**

MapType: `int`, MapSource: Internal Apache function

Here, the source is an internal Apache function. Currently you cannot create your own, but the following functions already exist:

- **toupper:**
Converts the key to all upper case.
- **tolower:**
Converts the key to all lower case.
- **escape:**
Translates special characters in the key to hex-encodings.
- **unescape:**
Translates hex-encodings in the key back to special characters.

- **External Rewriting Program**

MapType: `prog`, MapSource: Unix filesystem path to valid regular file

Here the source is a program, not a map file. To create it you can use a language of your choice, but the result has to be an executable program (either object-code or a script with the magic cookie trick `'#!/path/to/interpreter'` as the first line).

This program is started once, when the Apache server is started, and then communicates with the rewriting engine via its `stdin` and `stdout` file-handles. For each map-function lookup it will receive the key to lookup as a newline-terminated string on `stdin`. It then has to give back the looked-up value as a newline-terminated string on `stdout` or the four-character string "NULL" if it fails (*i.e.*, there is no corresponding value for the given key). A trivial program which will implement a 1:1 map (*i.e.*, `key == value`) could be:

```
#!/usr/bin/perl
$| = 1;
while (<STDIN>) {
    # ...put here any transformations or lookups...
    print $_;
}
```

But be very careful:

1. “*Keep it simple, stupid*” (KISS). If this program hangs, it will cause Apache to hang when trying to use the relevant rewrite rule.
2. A common mistake is to use buffered I/O on `stdout`. Avoid this, as it will cause a deadlock! “`$|=1`” is used above, to prevent this.
3. The `REWRITELOCK` directive can be used to define a lockfile which `mod_rewrite` can use to synchronize communication with the mapping program. By default no such synchronization takes place.

The `REWRITEMAP` directive can occur more than once. For each mapping-function use one `REWRITEMAP` directive to declare its rewriting mapfile. While you cannot **declare** a map in per-directory context it is of course possible to **use** this map in per-directory context.

⇒ Note

For plain text and DBM format files the looked-up keys are cached in-core until the `mtime` of the mapfile changes or the server does a restart. This way you can have map-functions in rules which are used for **every** request. This is no problem, because the external lookup only happens once!

RewriteOptions Directive

Description:	Sets some special options for the rewrite engine
Syntax:	<code>RewriteOptions Options</code>
Default:	<code>RewriteOptions MaxRedirects=10</code>
Context:	server config, virtual host, directory, <code>.htaccess</code>
Override:	<code>FileInfo</code>
Status:	Extension
Module:	<code>mod_rewrite</code>
Compatibility:	<code>MaxRedirects</code> is available in Apache 2.0.45 and later

The `REWRITEOPTIONS` directive sets some special options for the current per-server or per-directory configuration. The *Option* strings can be one of the following:

inherit This forces the current configuration to inherit the configuration of the parent. In per-virtual-server context this means that the maps, conditions and rules of the main server are inherited. In per-directory context this means that conditions and rules of the parent directory’s `.htaccess` configuration are inherited.

MaxRedirects=number In order to prevent endless loops of internal redirects issued by per-directory `REWRITERULES`, `MOD_REWRITE` aborts the request after reaching a maximum number of such redirects and responds with an 500 Internal Server Error. If you really need more internal redirects than 10 per request, you may increase the default to the desired value.

RewriteRule Directive

Description:	Defines rules for the rewriting engine
Syntax:	<code>RewriteRule Pattern Substitution</code>
Context:	server config, virtual host, directory, .htaccess
Override:	FileInfo
Status:	Extension
Module:	mod_rewrite
Compatibility:	The cookie-flag is available in Apache 2.0.40 and later.

The `REWRITERULE` directive is the real rewriting workhorse. The directive can occur more than once, with each instance defining a single rewrite rule. The order in which these rules are defined is important - this is the order in which they will be applied at run-time.

Pattern is a perl compatible regular expression, which is applied to the current URL. “Current” means the value of the URL when this rule is applied. This may not be the originally requested URL, which may already have matched a previous rule, and have been altered.

Some hints on the syntax of regular expressions:

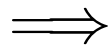

Text:	
.	Any single character
[chars]	Character class: Any character of the class ‘‘chars’’
[^chars]	Character class: Not a character of the class ‘‘chars’’
text1 text2	Alternative: text1 or text2
Quantifiers:	
?	0 or 1 occurrences of the preceding text
*	0 or N occurrences of the preceding text (N > 0)
+	1 or N occurrences of the preceding text (N > 1)
Grouping:	
(text)	Grouping of text (used either to set the borders of an alternative as above, or to make backreferences, where the Nth group can be referred to on the RHS of a RewriteRule as \$N)
Anchors:	
^	Start-of-line anchor
\$	End-of-line anchor
Escaping:	
\char	escape the given char (for instance, to specify the chars “.[]()” etc.)

For more information about regular expressions, have a look at the perl regular expression manpage (“perldoc perlre²⁸”). If you are interested in more detailed information about regular expressions and their variants (POSIX regex etc.) the following book is dedicated to this topic:

Mastering Regular Expressions, 2nd Edition
 Jeffrey E.F. Friedl
 O’Reilly & Associates, Inc. 2002
 ISBN 0-596-00289-0

²⁸<http://perldoc.perl.org/perlre.html>

In `mod_rewrite`, the NOT character (`!`) is also available as a possible pattern prefix. This enables you to negate a pattern; to say, for instance: “*if the current URL does NOT match this pattern*”. This can be used for exceptional cases, where it is easier to match the negative pattern, or as a last default rule.

⇒ Note

When using the NOT character to negate a pattern, you cannot include grouped wildcard parts in that pattern. This is because, when the pattern does NOT match (ie, the negation matches), there are no contents for the groups. Thus, if negated patterns are used, you cannot use `$N` in the substitution string!

The *substitution* of a rewrite rule is the string which is substituted for (or replaces) the original URL which *Pattern* matched. In addition to plain text, it can include

1. back-references (`$N`) to the RewriteRule pattern
2. back-references (`%N`) to the last matched RewriteCond pattern
3. server-variables as in rule condition test-strings (`%{VARIABLE}`)
4. mapping-function calls (`${mapname:key|default}`)

Back-references are identifiers of the form `$N` (`N=0..9`), which will be replaced by the contents of the `N`th group of the matched *Pattern*. The server-variables are the same as for the *TestString* of a `RewriteCond` directive. The mapping-functions come from the `RewriteMap` directive and are explained there. These three types of variables are expanded in the order above.

As already mentioned, all rewrite rules are applied to the *Substitution* (in the order in which they are defined in the config file). The URL is **completely replaced** by the *Substitution* and the rewriting process continues until all rules have been applied, or it is explicitly terminated by a `L` flag - see below.

There is a special substitution string named `'-'` which means: **NO substitution!** This is useful in providing rewriting rules which **only** match URLs but do not substitute anything for them. It is commonly used in conjunction with the `C` (chain) flag, in order to apply more than one pattern before substitution occurs.

Additionally you can set special flags for *Substitution* by appending `[flags]` as the third argument to the `RewriteRule` directive. *Flags* is a comma-separated list of any of the following flags:

- **'chain|C'** (chained with next rule)
This flag chains the current rule with the next rule (which itself can be chained with the following rule, and so on). This has the following effect: if a rule matches, then processing continues as usual - the flag has no effect. If the rule does **not** match, then all following chained rules are skipped. For instance, it can be used to remove the `“.www”` part, inside a per-directory rule set, when you let an external redirect happen (where the `“.www”` part should not occur!).
- **'cookie|CO=NAME:VAL:domain[:lifetime[:path]]'** (set cookie)
This sets a cookie in the client's browser. The cookie's name is specified by `NAME` and the value is `VAL`. The `domain` field is the domain of the cookie, such as `‘.apache.org’`, the optional `lifetime` is the lifetime of the cookie in minutes, and the optional `path` is the path of the cookie
- **'env|E=VAR:VAL'** (set environment variable)
This forces an environment variable named `VAR` to be set to the value `VAL`, where `VAL` can contain regexp backreferences (`$N` and `%N`) which will be expanded. You can use this flag more than once, to set more than one variable. The variables can later be dereferenced in many situations, most commonly from within XSSI (via `<!--#echo var="VAR"-->`) or CGI (`$ENV{'VAR'}`). You can also dereference the variable in a later `RewriteCond` pattern, using `%{ENV:VAR}`. Use this to strip information from URLs, while maintaining a record of that information.

- **'forbidden|F'** (force URL to be forbidden)
This forces the current URL to be forbidden - it immediately sends back a HTTP response of 403 (FORBIDDEN). Use this flag in conjunction with appropriate RewriteConds to conditionally block some URLs.
- **'gone|G'** (force URL to be gone)
This forces the current URL to be gone - it immediately sends back a HTTP response of 410 (GONE). Use this flag to mark pages which no longer exist as gone.
- **'last|L'** (last rule)
Stop the rewriting process here and don't apply any more rewrite rules. This corresponds to the Perl `last` command or the `break` command in C. Use this flag to prevent the currently rewritten URL from being rewritten further by following rules. For example, use it to rewrite the root-path URL ('/') to a real one, e.g., '/e/www/'.
- **'next|N'** (next round)
Re-run the rewriting process (starting again with the first rewriting rule). This time, the URL to match is no longer the original URL, but rather the URL returned by the last rewriting rule. This corresponds to the Perl `next` command or the `continue` command in C. Use this flag to restart the rewriting process - to immediately go to the top of the loop.
Be careful not to create an infinite loop!
- **'nocase|NC'** (no case)
This makes the *Pattern* case-insensitive, ignoring difference between 'A-Z' and 'a-z' when *Pattern* is matched against the current URL.
- **'noescape|NE'** (no URI escaping of output)
This flag prevents `mod_rewrite` from applying the usual URI escaping rules to the result of a rewrite. Ordinarily, special characters (such as '%', '\$', ';', and so on) will be escaped into their hexcode equivalents ('%25', '%24', and '%3B', respectively); this flag prevents this from happening. This allows percent symbols to appear in the output, as in

```
RewriteRule /foo/(.*) /bar?arg=P1\%3d$1 [R,NE]
```

which would turn '/foo/zed' into a safe request for '/bar?arg=P1=zed'.

- **'nosubreq|NS'** (not for internal sub-requests)
This flag forces the rewrite engine to skip a rewrite rule if the current request is an internal sub-request. For instance, sub-requests occur internally in Apache when `MOD_INCLUDE` tries to find out information about possible directory default files (`index.xxx`). On sub-requests it is not always useful, and can even cause errors, if the complete set of rules are applied. Use this flag to exclude some rules.
To decide whether or not to use this rule: if you prefix URLs with CGI-scripts, to force them to be processed by the CGI-script, it's likely that you will run into problems (or significant overhead) on sub-requests. In these cases, use this flag.
- **'proxy|P'** (force proxy)
This flag forces the substitution part to be internally sent as a proxy request and immediately (rewrite processing stops here) put through the proxy module (p. 504). You must make sure that the substitution string is a valid URI (typically starting with `http://hostname`) which can be handled by the Apache proxy module. If not, you will get an error from the proxy module. Use this flag to achieve a more powerful implementation of the `ProxyPass` (p. 504) directive, to map remote content into the namespace of the local server.
Note: `MOD_PROXY` must be enabled in order to use this flag.
- **'passthrough|PT'** (pass through to next handler)
This flag forces the rewrite engine to set the `uri` field of the internal `request_rec` structure to the value of the `filename` field. This flag is just a hack to enable post-processing of the output of `RewriteRule` directives, using `Alias`, `ScriptAlias`, `Redirect`, and other directives from various URI-to-filename translators. For example, to rewrite `/abc` to `/def` using `MOD_REWRITE`, and then `/def` to `/ghi` using `MOD_ALIAS`:

```
RewriteRule ^/abc(.*) /def$1 [PT]
Alias /def /ghi
```

If you omit the `PT` flag, `mod_rewrite` will rewrite `uri=/abc/...` to `filename=/def/...` as a full API-compliant URI-to-filename translator should do. Then `mod_alias` will try to do a URI-to-filename transition, which will fail.

Note: You must use this flag if you want to mix directives from different modules which allow URL-to-filename translators. The typical example is the use of `MOD_ALIAS` and `MOD_REWRITE`.

- **'qsappend|QSA'** (query string append)
This flag forces the rewrite engine to append a query string part of the substitution string to the existing string, instead of replacing it. Use this when you want to add more data to the query string via a rewrite rule.
- **'redirect|R[=code]'** (force redirect)
Prefix *Substitution* with `http://thishost[:thisport]/` (which makes the new URL a URI) to force an external redirection. If no *code* is given, a HTTP response of 302 (MOVED TEMPORARILY) will be returned. If you want to use other response codes in the range 300-400, simply specify the appropriate number or use one of the following symbolic names: `temp` (default), `permanent`, `seeother`. Use this for rules to canonicalize the URL and return it to the client - to translate `"/~"` into `"/u/"`, or to always append a slash to `/u/user`, etc.
Note: When you use this flag, make sure that the substitution field is a valid URL! Otherwise, you will be redirecting to an invalid location. Remember that this flag on its own will only prepend `http://thishost[:thisport]/` to the URL, and rewriting will continue. Usually, you will want to stop rewriting at this point, and redirect immediately. To stop rewriting, you should add the `'L'` flag.
- **'skip|S=num'** (skip next rule(s))
This flag forces the rewriting engine to skip the next *num* rules in sequence, if the current rule matches. Use this to make pseudo if-then-else constructs: The last rule of the then-clause becomes `skip=N`, where *N* is the number of rules in the else-clause. (This is **not** the same as the `'chain—C'` flag!)
- **'type|T=MIME-type'** (force MIME type)
Force the MIME-type of the target file to be *MIME-type*. This can be used to set up the content-type based on some conditions. For example, the following snippet allows `.php` files to be *displayed* by `mod_php` if they are called with the `.phps` extension:

```
RewriteRule ^(.+\.php)s$ $1 [T=application/x-httpd-php-source]
```

⇒ Home directory expansion

When the substitution string begins with a string resembling `"/user"` (via explicit text or backreferences), `mod_rewrite` performs home directory expansion independent of the presence or configuration of `MOD_USERDIR`.

This expansion does not occur when the `PT` flag is used on the `REWRITERULE` directive.

⇒ Note: Enabling rewrites in per-directory context

To enable the rewriting engine for per-directory configuration files, you need to set `"RewriteEngine On"` in these files **and** `"Options FollowSymLinks"` must be enabled. If your administrator has disabled override of `FollowSymLinks` for a user's directory, then you cannot use the rewriting engine. This restriction is needed for security reasons.

⇒ **Note: Pattern matching in per-directory context**

Never forget that *Pattern* is applied to a complete URL in per-server configuration files. **However, in per-directory configuration files, the per-directory prefix (which always is the same for a specific directory) is automatically removed for the pattern matching and automatically added after the substitution has been done.** This feature is essential for many sorts of rewriting - without this, you would always have to match the parent directory which is not always possible.

There is one exception: If a substitution string starts with “http://”, then the directory prefix will **not** be added, and an external redirect or proxy throughput (if flag **P** is used) is forced!

⇒ **Note: Substitution of Absolute URLs**

When you prefix a substitution field with `http://thishost[:thisport]`, **MOD.REWRITE** will automatically strip that out. This auto-reduction on URLs with an implicit external redirect is most useful in combination with a mapping-function which generates the hostname part.

Remember: An unconditional external redirect to your own server will not work with the prefix `http://thishost` because of this feature. To achieve such a self-redirect, you have to use the **R**-flag.

⇒ **Note: Query String**

The *Pattern* will not be matched against the query string. Instead, you must use a **REWRITE-COND** with the `%{QUERY_STRING}` variable. You can, however, create URLs in the substitution string, containing a query string part. Simply use a question mark inside the substitution string, to indicate that the following text should be re-injected into the query string. When you want to erase an existing query string, end the substitution string with just a question mark. To combine a new query string with an old one, use the `[QSA]` flag.

Here are all possible substitution combinations and their meanings:

**Inside per-server configuration (`httpd.conf`)
for request “GET /somepath/pathinfo”:**

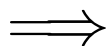

Given Rule	Resulting Substitution
<code>^/somepath(.*) otherpath\$1</code>	invalid, not supported
<code>^/somepath(.*) otherpath\$1 [R]</code>	invalid, not supported
<code>^/somepath(.*) otherpath\$1 [P]</code>	invalid, not supported
<code>^/somepath(.*) /otherpath\$1</code>	/otherpath/pathinfo
<code>^/somepath(.*) /otherpath\$1 [R]</code>	http://thishost/otherpath/pathinfo via external redirection
<code>^/somepath(.*) /otherpath\$1 [P]</code>	doesn't make sense, not supported
<code>^/somepath(.*) http://thishost/otherpath\$1</code>	/otherpath/pathinfo
<code>^/somepath(.*) http://thishost/otherpath\$1 [R]</code>	http://thishost/otherpath/pathinfo via external redirection
<code>^/somepath(.*) http://thishost/otherpath\$1 [P]</code>	doesn't make sense, not supported
<code>^/somepath(.*) http://otherhost/otherpath\$1</code>	http://otherhost/otherpath/pathinfo via external redirection
<code>^/somepath(.*) http://otherhost/otherpath\$1 [R]</code>	http://otherhost/otherpath/pathinfo via external redirection (the [R] flag is redundant)
<code>^/somepath(.*) http://otherhost/otherpath\$1 [P]</code>	http://otherhost/otherpath/pathinfo via internal proxy

**Inside per-directory configuration for `/somepath`
 (`/physical/path/to/somepath/.htaccess`, with `RewriteBase /somepath`)
 for request `"GET /somepath/localpath/pathinfo"`:**

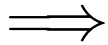

Given Rule	Resulting Substitution
<code>^localpath(.*) otherpath\$1</code>	<code>/somepath/otherpath/pathinfo</code>
<code>^localpath(.*) otherpath\$1 [R]</code>	<code>http://thishost/somepath/otherpath/p</code> via external redirection
<code>^localpath(.*) otherpath\$1 [P]</code>	doesn't make sense, not supported
<code>^localpath(.*) /otherpath\$1</code>	<code>/otherpath/pathinfo</code>
<code>^localpath(.*) /otherpath\$1 [R]</code>	<code>http://thishost/otherpath/pathinfo</code> via external redirection
<code>^localpath(.*) /otherpath\$1 [P]</code>	doesn't make sense, not supported
<code>^localpath(.*) http://thishost/otherpath\$1</code>	<code>/otherpath/pathinfo</code>
<code>^localpath(.*) http://thishost/otherpath\$1 [R]</code>	<code>http://thishost/otherpath/pathinfo</code> via external redirection
<code>^localpath(.*) http://thishost/otherpath\$1 [P]</code>	doesn't make sense, not supported
<code>^localpath(.*) http://otherhost/otherpath\$1</code>	<code>http://otherhost/otherpath/pathinfo</code> via external redirection
<code>^localpath(.*) http://otherhost/otherpath\$1 [R]</code>	<code>http://otherhost/otherpath/pathinfo</code> via external redirection (the [R] flag is redundant)
<code>^localpath(.*) http://otherhost/otherpath\$1 [P]</code>	<code>http://otherhost/otherpath/pathinfo</code> via internal proxy

10.50 Apache Module mod_setenvif

Description:	Allows the setting of environment variables based on characteristics of the request
Status:	Base
ModuleIdentifier:	setenvif_module
SourceFile:	mod_setenvif.c

Summary

The `MOD_SETENVIF` module allows you to set environment variables according to whether different aspects of the request match regular expressions you specify. These environment variables can be used by other parts of the server to make decisions about actions to be taken.

The directives are considered in the order they appear in the configuration files. So more complex sequences can be used, such as this example, which sets `netscape` if the browser is mozilla but not MSIE.

```
BrowserMatch ^Mozilla netscape
BrowserMatch MSIE !netscape
```

Directives

- `BrowserMatch`
- `BrowserMatchNoCase`
- `SetEnvIf`
- `SetEnvIfNoCase`

See also

- Environment Variables in Apache (p. 60)

BrowserMatch Directive

Description:	Sets environment variables conditional on HTTP User-Agent
Syntax:	<code>BrowserMatch regex [!]env-variable[=value]</code> <code>[[!]env-variable[=value]] ...</code>
Context:	server config, virtual host, directory, .htaccess
Override:	FileInfo
Status:	Base
Module:	mod_setenvif

The `BROWSERMATCH` is a special cases of the `SETENVIF` directive that sets environment variables conditional on the User-Agent HTTP request header. The following two lines have the same effect:

```
BrowserMatchNoCase Robot is_a_robot
SetEnvIfNoCase User-Agent Robot is_a_robot
```

Some additional examples:

```
BrowserMatch ^Mozilla forms jpeg=yes browser=netscape
BrowserMatch "^Mozilla/[2-3]" tables agif frames javascript
BrowserMatch MSIE !javascript
```

BrowserMatchNoCase Directive

Description:	Sets environment variables conditional on User-Agent without respect to case
Syntax:	<code>BrowserMatchNoCase <i>regex</i> [!]env-variable[=<i>value</i>]</code> <code>[!]env-variable[=<i>value</i>]] ...</code>
Context:	server config, virtual host, directory, .htaccess
Override:	FileInfo
Status:	Base
Module:	mod_setenvif
Compatibility:	Apache 1.2 and above (in Apache 1.2 this directive was found in the now-obsolete mod_browser module)

The `BROWSERMATCHNOCASE` directive is semantically identical to the `BROWSERMATCH` directive. However, it provides for case-insensitive matching. For example:

```
BrowserMatchNoCase mac platform=macintosh
BrowserMatchNoCase win platform=windows
```

The `BROWSERMATCH` and `BROWSERMATCHNOCASE` directives are special cases of the `SETENVIF` and `SETENVIFNOCASE` directives. The following two lines have the same effect:

```
BrowserMatchNoCase Robot is_a_robot
SetEnvIfNoCase User-Agent Robot is_a_robot
```

SetEnvIf Directive

Description:	Sets environment variables based on attributes of the request
Syntax:	<code>SetEnvIf <i>attribute</i> <i>regex</i> [!]env-variable[=<i>value</i>]</code> <code>[!]env-variable[=<i>value</i>]] ...</code>
Context:	server config, virtual host, directory, .htaccess
Override:	FileInfo
Status:	Base
Module:	mod_setenvif

The `SETENVIF` directive defines environment variables based on attributes of the request. The *attribute* specified in the first argument can be one of three things:

1. An HTTP request header field (see RFC2616²⁹ for more information about these); for example: `Host`, `User-Agent`, `Referer`, and `Accept-Language`. A regular expression may be used to specify a set of request headers.
2. One of the following aspects of the request:
 - `Remote_Host` - the hostname (if available) of the client making the request
 - `Remote_Addr` - the IP address of the client making the request
 - `Server_Addr` - the IP address of the server on which the request was received (only with versions later than 2.0.43)
 - `Request_Method` - the name of the method being used (`GET`, `POST`, *et cetera*)
 - `Request_Protocol` - the name and version of the protocol with which the request was made (*e.g.*, `"HTTP/0.9"`, `"HTTP/1.1"`, *etc.*)

²⁹<http://www.rfc-editor.org/rfc/rfc2616.txt>

- `Request_URI` - the resource requested on the HTTP request line – generally the portion of the URL following the scheme and host portion without the query string
3. The name of an environment variable in the list of those associated with the request. This allows `SETENVIF` directives to test against the result of prior matches. Only those environment variables defined by earlier `SetEnvIf [NoCase]` directives are available for testing in this manner. 'Earlier' means that they were defined at a broader scope (such as server-wide) or previously in the current directive's scope. Environment variables will be considered only if there was no match among request characteristics and a regular expression was not used for the *attribute*.

The second argument (*regex*) is a Perl compatible regular expression³⁰. This is similar to a POSIX.2 egrep-style regular expression. If the *regex* matches against the *attribute*, then the remainder of the arguments are evaluated.

The rest of the arguments give the names of variables to set, and optionally values to which they should be set. These take the form of

1. *varname*, or
2. `!varname`, or
3. *varname=value*

In the first form, the value will be set to "1". The second will remove the given variable if already defined, and the third will set the variable to the literal value given by *value*. Since version 2.0.51 Apache will recognize occurrences of `$1..$9` within *value* and replace them by parenthesized subexpressions of *regex*.

Example:

```
SetEnvIf Request_URI "\.gif$" object_is_image=gif
SetEnvIf Request_URI "\.jpg$" object_is_image=jpg
SetEnvIf Request_URI "\.xbm$" object_is_image=xbm
:
SetEnvIf Referer www\.\mydomain\.com intra_site_referral
:
SetEnvIf object_is_image xbm XBIT_PROCESSING=1
:
SetEnvIf ^TS* ^[a-z].* HAVE_TS
```

The first three will set the environment variable `object_is_image` if the request was for an image file, and the fourth sets `intra_site_referral` if the referring page was somewhere on the `www.mydomain.com` Web site.

The last example will set environment variable `HAVE_TS` if the request contains any headers that begin with "TS" whose values begins with any character in the set `[a-z]`.

See also

- Environment Variables in Apache (p. 60), for additional examples.

³⁰<http://www.pcre.org/>

SetEnvIfNoCase Directive

Description:	Sets environment variables based on attributes of the request without respect to case
Syntax:	<code>SetEnvIfNoCase attribute regex [!]env-variable[=value]</code> <code>[!]env-variable[=value] ...</code>
Context:	server config, virtual host, directory, .htaccess
Override:	FileInfo
Status:	Base
Module:	mod_setenvif
Compatibility:	Apache 1.3 and above

The [SETENVIFNOCASE](#) is semantically identical to the [SETENVIF](#) directive, and differs only in that the regular expression matching is performed in a case-insensitive manner. For example:

```
SetEnvIfNoCase Host Apache\.Org site=apache
```

This will cause the `site` environment variable to be set to "apache" if the HTTP request header field `Host :` was included and contained `Apache.Org`, `apache.org`, or any other combination.

10.51 Apache Module mod_so

Description:	Loading of executable code and modules into the server at start-up or restart time
Status:	Extension
ModuleIdentifier:	so_module
SourceFile:	mod_so.c
Compatibility:	This is a Base module (always included) on Windows

Summary

On selected operating systems this module can be used to load modules into Apache at runtime via the Dynamic Shared Object (p. 44) (DSO) mechanism, rather than requiring a recompilation.

On Unix, the loaded code typically comes from shared object files (usually with `.so` extension), on Windows this may either be the `.so` or `.dll` extension.



Warning

Apache 1.3 modules cannot be directly used with Apache 2.0 - the module must be modified to dynamically load or compile into Apache 2.0.

Directives

- LoadFile
- LoadModule

Creating Loadable Modules for Windows

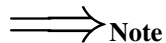

Note

The module name format changed for Windows with Apache 1.3.15 and 2.0 - the modules are now named as `mod_foo.so`

While `mod_so` still loads modules with `ApacheModuleFoo.dll` names, the new naming convention is preferred; if you are converting your loadable module for 2.0, please fix the name to this 2.0 convention.

The Apache module API is unchanged between the Unix and Windows versions. Many modules will run on Windows with no or little change from Unix, although others rely on aspects of the Unix architecture which are not present in Windows, and will not work.

When a module does work, it can be added to the server in one of two ways. As with Unix, it can be compiled into the server. Because Apache for Windows does not have the `Configure` program of Apache for Unix, the module's source file must be added to the `ApacheCore` project file, and its symbols must be added to the `os\win32\modules.c` file.

The second way is to compile the module as a DLL, a shared library that can be loaded into the server at runtime, using the `LOADMODULE` directive. These module DLLs can be distributed and run on any Apache for Windows installation, without recompilation of the server.

To create a module DLL, a small change is necessary to the module's source file: The module record must be exported from the DLL (which will be created later; see below). To do this, add the `AP_MODULE_DECLARE_DATA` (defined in the Apache header files) to your module's module record definition. For example, if your module has:

```
module foo_module;
```

Replace the above with:

```
module AP_MODULE_DECLARE_DATA foo_module;
```

Note that this will only be activated on Windows, so the module can continue to be used, unchanged, with Unix if needed. Also, if you are familiar with `.DEF` files, you can export the module record with that method instead.

Now, create a DLL containing your module. You will need to link this against the `libhttpd.lib` export library that is created when the `libhttpd.dll` shared library is compiled. You may also have to change the compiler settings to ensure that the Apache header files are correctly located. You can find this library in your server root's modules directory. It is best to grab an existing module `.dsp` file from the tree to assure the build environment is configured correctly, or alternately compare the compiler and link options to your `.dsp`.

This should create a DLL version of your module. Now simply place it in the `modules` directory of your server root, and use the `LOADMODULE` directive to load it.

LoadFile Directive

Description:	Link in the named object file or library
Syntax:	<code>LoadFile filename [filename] ...</code>
Context:	server config
Status:	Extension
Module:	<code>mod_so</code>

The `LoadFile` directive links in the named object files or libraries when the server is started or restarted; this is used to load additional code which may be required for some module to work. *Filename* is either an absolute path or relative to `ServerRoot` (p. 302).

For example:

```
LoadFile libexec/libxmlparse.so
```

LoadModule Directive

Description:	Links in the object file or library, and adds to the list of active modules
Syntax:	<code>LoadModule module filename</code>
Context:	server config
Status:	Extension
Module:	<code>mod_so</code>

The `LoadModule` directive links in the object file or library *filename* and adds the module structure named *module* to the list of active modules. *Module* is the name of the external variable of type `module` in the file, and is listed as the Module Identifier (p. 298) in the module documentation. Example:

```
LoadModule status_module modules/mod_status.so
```

loads the named module from the `modules` subdirectory of the `ServerRoot`.

10.52 Apache Module mod_speling

Description:	Attempts to correct mistaken URLs that users might have entered by ignoring capitalization and by allowing up to one misspelling
Status:	Extension
ModuleIdentifier:	speling_module
SourceFile:	mod_speling.c

Summary

Requests to documents sometimes cannot be served by the core apache server because the request was misspelled or miscapitalized. This module addresses this problem by trying to find a matching document, even after all other modules gave up. It does its work by comparing each document name in the requested directory against the requested document name **without regard to case**, and allowing **up to one misspelling** (character insertion / omission / transposition or wrong character). A list is built with all document names which were matched using this strategy.

If, after scanning the directory,

- no matching document was found, Apache will proceed as usual and return a "document not found" error.
- only one document is found that "almost" matches the request, then it is returned in the form of a redirection response.
- more than one document with a close match was found, then the list of the matches is returned to the client, and the client can select the correct candidate.

Directives

- CheckSpelling

CheckSpelling Directive

Description:	Enables the spelling module
Syntax:	CheckSpelling on off
Default:	CheckSpelling Off
Context:	server config, virtual host, directory, .htaccess
Override:	Options
Status:	Extension
Module:	mod_speling
Compatibility:	CheckSpelling was available as a separately available module for Apache 1.1, but was limited to miscapitalizations. As of Apache 1.3, it is part of the Apache distribution. Prior to Apache 1.3.2, the CheckSpelling directive was only available in the "server" and "virtual host" contexts.

This directive enables or disables the spelling module. When enabled, keep in mind that

- the directory scan which is necessary for the spelling correction will have an impact on the server's performance when many spelling corrections have to be performed at the same time.
- the document trees should not contain sensitive files which could be matched inadvertently by a spelling "correction".
- the module is unable to correct misspelled user names (as in `http://my.host/~apahce/`), just file names or directory names.

- spelling corrections apply strictly to existing files, so a request for the `<Location /status>` may get incorrectly treated as the negotiated file `"/stats.html"`.

10.53 Apache Module mod_ssl

Description:	Strong cryptography using the Secure Sockets Layer (SSL) and Transport Layer Security (TLS) protocols
Status:	Extension
ModuleIdentifier:	ssl_module
SourceFile:	mod_ssl.c

Summary

This module provides SSL v2/v3 and TLS v1 support for the Apache HTTP Server. It was contributed by Ralf S. Engeschall based on his mod_ssl project and originally derived from work by Ben Laurie.

This module relies on OpenSSL³¹ to provide the cryptography engine.

Further details, discussion, and examples are provided in the SSL documentation (p. 146) .

Directives

- SSLCACertificateFile
- SSLCACertificatePath
- SSLCARevocationFile
- SSLCARevocationPath
- SSLCertificateChainFile
- SSLCertificateFile
- SSLCertificateKeyFile
- SSLCipherSuite
- SSLEngine
- SSLMutex
- SSLOptions
- SSLPassPhraseDialog
- SSLProtocol
- SSLProxyCACertificateFile
- SSLProxyCACertificatePath
- SSLProxyCARevocationFile
- SSLProxyCARevocationPath
- SSLProxyCipherSuite
- SSLProxyEngine
- SSLProxyMachineCertificateFile
- SSLProxyMachineCertificatePath
- SSLProxyProtocol
- SSLProxyVerify
- SSLProxyVerifyDepth
- SSLRandomSeed

³¹<http://www.openssl.org/>

- SSLRequire
- SSLRequireSSL
- SSLSessionCache
- SSLSessionCacheTimeout
- SSLUserName
- SSLVerifyClient
- SSLVerifyDepth

Environment Variables

This module provides a lot of SSL information as additional environment variables to the SSI and CGI namespace. The generated variables are listed in the table below. For backward compatibility the information can be made available under different names, too. Look in the Compatibility (p. 156) chapter for details on the compatibility variables.

Variable Name:	Value Type:	Description:
HTTPS	flag	HTTPS is being used.
SSL_PROTOCOL	string	The SSL protocol version (SSLv2, SSLv3, TLSv1)
SSL_SESSION_ID	string	The hex-encoded SSL session id
SSL_CIPHER	string	The cipher specification name
SSL_CIPHER_EXPORT	string	<code>true</code> if cipher is an export cipher
SSL_CIPHER_USEKEYSIZE	number	Number of cipher bits (actually used)
SSL_CIPHER_ALGKEYSIZE	number	Number of cipher bits (possible)
SSL_VERSION_INTERFACE	string	The <code>mod_ssl</code> program version
SSL_VERSION_LIBRARY	string	The OpenSSL program version
SSL_CLIENT_M_VERSION	string	The version of the client certificate
SSL_CLIENT_M_SERIAL	string	The serial of the client certificate
SSL_CLIENT_S_DN	string	Subject DN in client's certificate
SSL_CLIENT_S_DN_x509	string	Component of client's Subject DN
SSL_CLIENT_I_DN	string	Issuer DN of client's certificate
SSL_CLIENT_I_DN_x509	string	Component of client's Issuer DN
SSL_CLIENT_V_START	string	Validity of client's certificate (start time)
SSL_CLIENT_V_END	string	Validity of client's certificate (end time)
SSL_CLIENT_A_SIG	string	Algorithm used for the signature of client's certificate
SSL_CLIENT_A_KEY	string	Algorithm used for the public key of client's certificate
SSL_CLIENT_CERT	string	PEM-encoded client certificate
SSL_CLIENT_CERT_CHAIN <i>n</i>	string	PEM-encoded certificates in client certificate chain
SSL_CLIENT_VERIFY	string	NONE, SUCCESS, GENEROUS or FAILED : <i>reason</i>
SSL_SERVER_M_VERSION	string	The version of the server certificate
SSL_SERVER_M_SERIAL	string	The serial of the server certificate
SSL_SERVER_S_DN	string	Subject DN in server's certificate
SSL_SERVER_S_DN_x509	string	Component of server's Subject DN
SSL_SERVER_I_DN	string	Issuer DN of server's certificate
SSL_SERVER_I_DN_x509	string	Component of server's Issuer DN
SSL_SERVER_V_START	string	Validity of server's certificate (start time)
SSL_SERVER_V_END	string	Validity of server's certificate (end time)
SSL_SERVER_A_SIG	string	Algorithm used for the signature of server's certificate
SSL_SERVER_A_KEY	string	Algorithm used for the public key of server's certificate
SSL_SERVER_CERT	string	PEM-encoded server certificate

[where *x509* is a component of a X.509 DN: C, ST, L, O, OU, CN, T, I, G, S, D, UID, Email]

Custom Log Formats

When `MOD_SSL` is built into Apache or at least loaded (under DSO situation) additional functions exist for the Custom Log Format (p. 471) of `MOD_LOG_CONFIG`. First there is an additional “`{varname}x`” eXtension format function which can be used to expand any variables provided by any module, especially those provided by `mod_ssl` which can you find in the above table.

For backward compatibility there is additionally a special “`{name}c`” cryptography format function provided. Information about this function is provided in the Compatibility (p. 156) chapter.

Example:

```
CustomLog logs/ssl_request_log \"%t %h %{SSL-PROTOCOL}x %{SSL-CIPHER}x
\"%r\" %b"
```

SSLCACertificateFile Directive

Description: File of concatenated PEM-encoded CA Certificates for Client Auth
 Syntax: `SSLCACertificateFile file-path`
 Context: server config, virtual host
 Status: Extension
 Module: `mod_ssl`

This directive sets the *all-in-one* file where you can assemble the Certificates of Certification Authorities (CA) whose *clients* you deal with. These are used for Client Authentication. Such a file is simply the concatenation of the various PEM-encoded Certificate files, in order of preference. This can be used alternatively and/or additionally to [SSLCACERTIFICATEPATH](#).

Example

```
SSLCACertificateFile
/usr/local/apache2/conf/ssl.crt/ca-bundle-client.crt
```

SSLCACertificatePath Directive

Description: Directory of PEM-encoded CA Certificates for Client Auth
 Syntax: `SSLCACertificatePath directory-path`
 Context: server config, virtual host
 Status: Extension
 Module: `mod_ssl`

This directive sets the directory where you keep the Certificates of Certification Authorities (CAs) whose clients you deal with. These are used to verify the client certificate on Client Authentication.

The files in this directory have to be PEM-encoded and are accessed through hash filenames. So usually you can't just place the Certificate files there: you also have to create symbolic links named *hash-value.N*. And you should always make sure this directory contains the appropriate symbolic links.

Example

```
SSLCACertificatePath /usr/local/apache2/conf/ssl.crt/
```

SSLCARevocationFile Directive

Description:	File of concatenated PEM-encoded CA CRLs for Client Auth
Syntax:	SSLCARevocationFile <i>file-path</i>
Context:	server config, virtual host
Status:	Extension
Module:	mod_ssl

This directive sets the *all-in-one* file where you can assemble the Certificate Revocation Lists (CRL) of Certification Authorities (CA) whose *clients* you deal with. These are used for Client Authentication. Such a file is simply the concatenation of the various PEM-encoded CRL files, in order of preference. This can be used alternatively and/or additionally to [SSLCAREVOCATIONPATH](#).

Example

```
SSLCARevocationFile
/usr/local/apache2/conf/ssl.crl/ca-bundle-client.crl
```

SSLCARevocationPath Directive

Description:	Directory of PEM-encoded CA CRLs for Client Auth
Syntax:	SSLCARevocationPath <i>directory-path</i>
Context:	server config, virtual host
Status:	Extension
Module:	mod_ssl

This directive sets the directory where you keep the Certificate Revocation Lists (CRL) of Certification Authorities (CAs) whose clients you deal with. These are used to revoke the client certificate on Client Authentication.

The files in this directory have to be PEM-encoded and are accessed through hash filenames. So usually you have not only to place the CRL files there. Additionally you have to create symbolic links named *hash-value*.*rN*. And you should always make sure this directory contains the appropriate symbolic links.

Example

```
SSLCARevocationPath /usr/local/apache2/conf/ssl.crl/
```

SSLCertificateChainFile Directive

Description:	File of PEM-encoded Server CA Certificates
Syntax:	SSLCertificateChainFile <i>file-path</i>
Context:	server config, virtual host
Status:	Extension
Module:	mod_ssl

This directive sets the optional *all-in-one* file where you can assemble the certificates of Certification Authorities (CA) which form the certificate chain of the server certificate. This starts with the issuing CA certificate of of the server certificate and can range up to the root CA certificate. Such a file is simply the concatenation of the various PEM-encoded CA Certificate files, usually in certificate chain order.

This should be used alternatively and/or additionally to [SSLCACERTIFICATEPATH](#) for explicitly constructing the server certificate chain which is sent to the browser in addition to the server certificate. It is especially useful to avoid conflicts with CA certificates when using client authentication. Because although placing a CA certificate of the server certificate chain into [SSLCACERTIFICATEPATH](#) has the same effect for the certificate chain construction, it has the

side-effect that client certificates issued by this same CA certificate are also accepted on client authentication. That's usually not one expect.

But be careful: Providing the certificate chain works only if you are using a *single* (either RSA or DSA) based server certificate. If you are using a coupled RSA+DSA certificate pair, this will work only if actually both certificates use the *same* certificate chain. Else the browsers will be confused in this situation.

Example

```
SSLCertificateChainFile /usr/local/apache2/conf/ssl.crt/ca.crt
```

SSLCertificateFile Directive

Description:	Server PEM-encoded X.509 Certificate file
Syntax:	SSLCertificateFile <i>file-path</i>
Context:	server config, virtual host
Status:	Extension
Module:	mod_ssl

This directive points to the PEM-encoded Certificate file for the server and optionally also to the corresponding RSA or DSA Private Key file for it (contained in the same file). If the contained Private Key is encrypted the Pass Phrase dialog is forced at startup time. This directive can be used up to two times (referencing different filenames) when both a RSA and a DSA based server certificate is used in parallel.

Example

```
SSLCertificateFile /usr/local/apache2/conf/ssl.crt/server.crt
```

SSLCertificateKeyFile Directive

Description:	Server PEM-encoded Private Key file
Syntax:	SSLCertificateKeyFile <i>file-path</i>
Context:	server config, virtual host
Status:	Extension
Module:	mod_ssl

This directive points to the PEM-encoded Private Key file for the server. If the Private Key is not combined with the Certificate in the [SSLCERTIFICATEFILE](#), use this additional directive to point to the file with the stand-alone Private Key. When [SSLCERTIFICATEFILE](#) is used and the file contains both the Certificate and the Private Key this directive need not be used. But we strongly discourage this practice. Instead we recommend you to separate the Certificate and the Private Key. If the contained Private Key is encrypted, the Pass Phrase dialog is forced at startup time. This directive can be used up to two times (referencing different filenames) when both a RSA and a DSA based private key is used in parallel.

Example

```
SSLCertificateKeyFile /usr/local/apache2/conf/ssl.key/server.key
```

SSLCipherSuite Directive

Description:	Cipher Suite available for negotiation in SSL handshake
Syntax:	SSLCipherSuite <i>cipher-spec</i>
Default:	SSLCipherSuite ALL:!ADH:RC4+RSA:+HIGH:+MEDIUM:+LOW:+SSLv2:+EXP
Context:	server config, virtual host, directory, .htaccess
Override:	AuthConfig
Status:	Extension
Module:	mod_ssl

This complex directive uses a colon-separated *cipher-spec* string consisting of OpenSSL cipher specifications to configure the Cipher Suite the client is permitted to negotiate in the SSL handshake phase. Notice that this directive can be used both in per-server and per-directory context. In per-server context it applies to the standard SSL handshake when a connection is established. In per-directory context it forces a SSL renegotiation with the reconfigured Cipher Suite after the HTTP request was read but before the HTTP response is sent.

An SSL cipher specification in *cipher-spec* is composed of 4 major attributes plus a few extra minor ones:

- *Key Exchange Algorithm:*
RSA or Diffie-Hellman variants.
- *Authentication Algorithm:*
RSA, Diffie-Hellman, DSS or none.
- *Cipher/Encryption Algorithm:*
DES, Triple-DES, RC4, RC2, IDEA or none.
- *MAC Digest Algorithm:*
MD5, SHA or SHA1.

An SSL cipher can also be an export cipher and is either a SSLv2 or SSLv3/TLSv1 cipher (here TLSv1 is equivalent to SSLv3). To specify which ciphers to use, one can either specify all the Ciphers, one at a time, or use aliases to specify the preference and order for the ciphers (see Table 1).

Tag	Description
<i>Key Exchange Algorithm:</i>	
kRSA	RSA key exchange
kDHr	Diffie-Hellman key exchange with RSA key
kDHd	Diffie-Hellman key exchange with DSA key
kEDH	Ephemeral (temp.key) Diffie-Hellman key exchange (no cert)
<i>Authentication Algorithm:</i>	
aNULL	No authentication
aRSA	RSA authentication
aDSS	DSS authentication
aDH	Diffie-Hellman authentication
<i>Cipher Encoding Algorithm:</i>	
eNULL	No encoding
DES	DES encoding
3DES	Triple-DES encoding
RC4	RC4 encoding
RC2	RC2 encoding
IDEA	IDEA encoding
<i>MAC Digest Algorithm:</i>	
MD5	MD5 hash function
SHA1	SHA1 hash function

SHA	SHA hash function
<i>Aliases:</i>	
SSLv2	all SSL version 2.0 ciphers
SSLv3	all SSL version 3.0 ciphers
TLSv1	all TLS version 1.0 ciphers
EXP	all export ciphers
EXPORT40	all 40-bit export ciphers only
EXPORT56	all 56-bit export ciphers only
LOW	all low strength ciphers (no export, single DES)
MEDIUM	all ciphers with 128 bit encryption
HIGH	all ciphers using Triple-DES
RSA	all ciphers using RSA key exchange
DH	all ciphers using Diffie-Hellman key exchange
EDH	all ciphers using Ephemeral Diffie-Hellman key exchange
ADH	all ciphers using Anonymous Diffie-Hellman key exchange
DSS	all ciphers using DSS authentication
NULL	all ciphers using no encryption

Now where this becomes interesting is that these can be put together to specify the order and ciphers you wish to use. To speed this up there are also aliases (SSLv2, SSLv3, TLSv1, EXP, LOW, MEDIUM, HIGH) for certain groups of ciphers. These tags can be joined together with prefixes to form the *cipher-spec*. Available prefixes are:

- none: add cipher to list
- +: add ciphers to list and pull them to current location in list
- -: remove cipher from list (can be added later again)
- !: kill cipher from list completely (can **not** be added later again)

A simpler way to look at all of this is to use the “`openssl ciphers -v`” command which provides a nice way to successively create the correct *cipher-spec* string. The default *cipher-spec* string is “`ALL:!ADH:RC4+RSA:+HIGH:+MEDIUM:+LOW:+SSLv2:+EXP`” which means the following: first, remove from consideration any ciphers that do not authenticate, i.e. for SSL only the Anonymous Diffie-Hellman ciphers. Next, use ciphers using RC4 and RSA. Next include the high, medium and then the low security ciphers. Finally *pull* all SSLv2 and export ciphers to the end of the list.

```
$ openssl ciphers -v 'ALL:!ADH:RC4+RSA:+HIGH:+MEDIUM:+LOW:+SSLv2:+EXP'
NULL-SHA          SSLv3 Kx=RSA      Au=RSA  Enc=None  Mac=SHA1
NULL-MD5          SSLv3 Kx=RSA      Au=RSA  Enc=None  Mac=MD5
EDH-RSA-DES-CBC3-SHA  SSLv3 Kx=DH      Au=RSA  Enc=3DES (168) Mac=SHA1
...
EXP-RC4-MD5       SSLv3 Kx=RSA (512) Au=RSA  Enc=RC4 (40) Mac=MD5  export
EXP-RC2-CBC-MD5   SSLv2 Kx=RSA (512) Au=RSA  Enc=RC2 (40) Mac=MD5  export
EXP-RC4-MD5       SSLv2 Kx=RSA (512) Au=RSA  Enc=RC4 (40) Mac=MD5  export
```

The complete list of particular RSA & DH ciphers for SSL is given in Table 2.

Example

```
SSLCipherSuite RSA:!EXP:!NULL:+HIGH:+MEDIUM:-LOW
```

Cipher-Tag	Protocol	Key Ex.	Auth.	Enc.	MAC	Type
<i>RSA Ciphers:</i>						
DES-CBC3-SHA	SSLv3	RSA	RSA	3DES(168)	SHA1	
DES-CBC3-MD5	SSLv2	RSA	RSA	3DES(168)	MD5	
IDEA-CBC-SHA	SSLv3	RSA	RSA	IDEA(128)	SHA1	
RC4-SHA	SSLv3	RSA	RSA	RC4(128)	SHA1	
RC4-MD5	SSLv3	RSA	RSA	RC4(128)	MD5	
IDEA-CBC-MD5	SSLv2	RSA	RSA	IDEA(128)	MD5	
RC2-CBC-MD5	SSLv2	RSA	RSA	RC2(128)	MD5	
RC4-MD5	SSLv2	RSA	RSA	RC4(128)	MD5	
DES-CBC-SHA	SSLv3	RSA	RSA	DES(56)	SHA1	
RC4-64-MD5	SSLv2	RSA	RSA	RC4(64)	MD5	
DES-CBC-MD5	SSLv2	RSA	RSA	DES(56)	MD5	
EXP-DES-CBC-SHA	SSLv3	RSA(512)	RSA	DES(40)	SHA1	export
EXP-RC2-CBC-MD5	SSLv3	RSA(512)	RSA	RC2(40)	MD5	export
EXP-RC4-MD5	SSLv3	RSA(512)	RSA	RC4(40)	MD5	export
EXP-RC2-CBC-MD5	SSLv2	RSA(512)	RSA	RC2(40)	MD5	export
EXP-RC4-MD5	SSLv2	RSA(512)	RSA	RC4(40)	MD5	export
NULL-SHA	SSLv3	RSA	RSA	None	SHA1	
NULL-MD5	SSLv3	RSA	RSA	None	MD5	
<i>Diffie-Hellman Ciphers:</i>						
ADH-DES-CBC3-SHA	SSLv3	DH	None	3DES(168)	SHA1	
ADH-DES-CBC-SHA	SSLv3	DH	None	DES(56)	SHA1	
ADH-RC4-MD5	SSLv3	DH	None	RC4(128)	MD5	
EDH-RSA-DES-CBC3-SHA	SSLv3	DH	RSA	3DES(168)	SHA1	
EDH-DSS-DES-CBC3-SHA	SSLv3	DH	DSS	3DES(168)	SHA1	
EDH-RSA-DES-CBC-SHA	SSLv3	DH	RSA	DES(56)	SHA1	
EDH-DSS-DES-CBC-SHA	SSLv3	DH	DSS	DES(56)	SHA1	
EXP-EDH-RSA-DES-CBC-SHA	SSLv3	DH(512)	RSA	DES(40)	SHA1	export
EXP-EDH-DSS-DES-CBC-SHA	SSLv3	DH(512)	DSS	DES(40)	SHA1	export
EXP-ADH-DES-CBC-SHA	SSLv3	DH(512)	None	DES(40)	SHA1	export
EXP-ADH-RC4-MD5	SSLv3	DH(512)	None	RC4(40)	MD5	export

SSLEngine Directive

Description: SSL Engine Operation Switch
Syntax: SSLEngine on|off
Default: SSLEngine off
Context: server config, virtual host
Status: Extension
Module: mod_ssl

This directive toggles the usage of the SSL/TLS Protocol Engine. This is usually used inside a `<VIRTUALHOST>` section to enable SSL/TLS for a particular virtual host. By default the SSL/TLS Protocol Engine is disabled for both the main server and all configured virtual hosts.

Example

```

<VirtualHost _default_:443>
SSLEngine on
...
</VirtualHost>

```

SSLMutex Directive

Description:	Semaphore for internal mutual exclusion of operations
Syntax:	SSLMutex <i>type</i>
Default:	SSLMutex none
Context:	server config
Status:	Extension
Module:	mod_ssl

This configures the SSL engine's semaphore (aka. lock) which is used for mutual exclusion of operations which have to be done in a synchronized way between the pre-forked Apache server processes. This directive can only be used in the global server context because it's only useful to have one global mutex. This directive is designed to closely match the AcceptMutex³² directive

The following Mutex *types* are available:

- none | no

This is the default where no Mutex is used at all. Use it at your own risk. But because currently the Mutex is mainly used for synchronizing write access to the SSL Session Cache you can live without it as long as you accept a sometimes garbled Session Cache. So it's not recommended to leave this the default. Instead configure a real Mutex.

- posixsem

This is an elegant Mutex variant where a Posix Semaphore is used when possible. It is only available when the underlying platform and APR supports it.

- sysvsem

This is a somewhat elegant Mutex variant where a SystemV IPC Semaphore is used when possible. It is possible to "leak" SysV semaphores if processes crash before the semaphore is removed. It is only available when the underlying platform and APR supports it.

- sem

This directive tells the SSL Module to pick the "best" semaphore implementation available to it, choosing between Posix and SystemV IPC, in that order. It is only available when the underlying platform and APR supports at least one of the 2.

- pthread

This directive tells the SSL Module to use Posix thread mutexes. It is only available if the underlying platform and APR supports it.

- fcntl:/path/to/mutex

This is a portable Mutex variant where a physical (lock-)file and the `fcntl()` function are used as the Mutex. Always use a local disk filesystem for `/path/to/mutex` and never a file residing on a NFS- or AFS-filesystem. It is only available when the underlying platform and APR supports it. Note: Internally, the Process ID (PID) of the Apache parent process is automatically appended to `/path/to/mutex` to make it unique, so you don't have to worry about conflicts yourself. Notice that this type of mutex is not available under the Win32 environment. There you *have* to use the semaphore mutex.

- flock:/path/to/mutex

This is similar to the `fcntl:/path/to/mutex` method with the exception that the `flock()` function is used to provide file locking. It is only available when the underlying platform and APR supports it.

- file:/path/to/mutex

This directive tells the SSL Module to pick the "best" file locking implementation available to it, choosing between `fcntl` and `flock`, in that order. It is only available when the underlying platform and APR supports at least one of the 2.

³²http://httpd.apache.org/docs/2.0/mod/mpm_common.html#acceptmutex

- default | yes

This directive tells the SSL Module to pick the default locking implementation as determined by the platform and APR.

Example

```
SSLMutex file:/usr/local/apache/logs/ssl_mutex
```

SSLOptions Directive

Description:	Configure various SSL engine run-time options
Syntax:	SSLOptions [+ -]option ...
Context:	server config, virtual host, directory, .htaccess
Override:	Options
Status:	Extension
Module:	mod_ssl

This directive can be used to control various run-time options on a per-directory basis. Normally, if multiple `SSLOptions` could apply to a directory, then the most specific one is taken completely; the options are not merged. However if *all* the options on the `SSLOptions` directive are preceded by a plus (+) or minus (-) symbol, the options are merged. Any options preceded by a + are added to the options currently in force, and any options preceded by a - are removed from the options currently in force.

The available *options* are:

- StdEnvVars

When this option is enabled, the standard set of SSL related CGI/SSI environment variables are created. This per default is disabled for performance reasons, because the information extraction step is a rather expensive operation. So one usually enables this option for CGI and SSI requests only.

- CompatEnvVars

When this option is enabled, additional CGI/SSI environment variables are created for backward compatibility to other Apache SSL solutions. Look in the Compatibility (p. 156) chapter for details on the particular variables generated.

- ExportCertData

When this option is enabled, additional CGI/SSI environment variables are created: `SSL_SERVER_CERT`, `SSL_CLIENT_CERT` and `SSL_CLIENT_CERT_CHAINn` (with $n = 0,1,2,\dots$). These contain the PEM-encoded X.509 Certificates of server and client for the current HTTPS connection and can be used by CGI scripts for deeper Certificate checking. Additionally all other certificates of the client certificate chain are provided, too. This bloats up the environment a little bit which is why you have to use this option to enable it on demand.

- FakeBasicAuth

When this option is enabled, the Subject Distinguished Name (DN) of the Client X509 Certificate is translated into a HTTP Basic Authorization username. This means that the standard Apache authentication methods can be used for access control. The user name is just the Subject of the Client's X509 Certificate (can be determined by running OpenSSL's `openssl x509` command: `openssl x509 -noout -subject -in certificate.crt`). Note that no password is obtained from the user. Every entry in the user file needs this password: "xxj31ZMTZzkVA", which is the DES-encrypted version of the word 'password'. Those who live under MD5-based encryption (for instance under FreeBSD or BSD/OS, etc.) should use the following MD5 hash of the same word: "\$1\$0XLYS...\$0wx8s2/m9/gfkcRVXzgoE/".

- `StrictRequire`

This *forces* forbidden access when `SSLRequireSSL` or `SSLRequire` successfully decided that access should be forbidden. Usually the default is that in the case where a “`Satisfy any`” directive is used, and other access restrictions are passed, denial of access due to `SSLRequireSSL` or `SSLRequire` is overridden (because that’s how the Apache `Satisfy` mechanism should work.) But for strict access restriction you can use `SSLRequireSSL` and/or `SSLRequire` in combination with an “`SSLOptions +StrictRequire`”. Then an additional “`Satisfy Any`” has no chance once `mod_ssl` has decided to deny access.

- `OptRenegotiate`

This enables optimized SSL connection renegotiation handling when SSL directives are used in per-directory context. By default a strict scheme is enabled where *every* per-directory reconfiguration of SSL parameters causes a *full* SSL renegotiation handshake. When this option is used `mod_ssl` tries to avoid unnecessary handshakes by doing more granular (but still safe) parameter checks. Nevertheless these granular checks sometimes maybe not what the user expects, so enable this on a per-directory basis only, please.

Example

```
SSLOptions +FakeBasicAuth -StrictRequire
<Files ~ "\.(cgi|shtml)$">
SSLOptions +StdEnvVars +CompatEnvVars -ExportCertData
</Files>
```

SSLPassPhraseDialog Directive

Description:	Type of pass phrase dialog for encrypted private keys
Syntax:	<code>SSLPassPhraseDialog type</code>
Default:	<code>SSLPassPhraseDialog builtin</code>
Context:	server config
Status:	Extension
Module:	<code>mod_ssl</code>

When Apache starts up it has to read the various Certificate (see [SSLCERTIFICATEFILE](#)) and Private Key (see [SSLCERTIFICATEKEYFILE](#)) files of the SSL-enabled virtual servers. Because for security reasons the Private Key files are usually encrypted, `mod_ssl` needs to query the administrator for a Pass Phrase in order to decrypt those files. This query can be done in two ways which can be configured by *type*:

- `builtin`

This is the default where an interactive terminal dialog occurs at startup time just before Apache detaches from the terminal. Here the administrator has to manually enter the Pass Phrase for each encrypted Private Key file. Because a lot of SSL-enabled virtual hosts can be configured, the following reuse-scheme is used to minimize the dialog: When a Private Key file is encrypted, all known Pass Phrases (at the beginning there are none, of course) are tried. If one of those known Pass Phrases succeeds no dialog pops up for this particular Private Key file. If none succeeded, another Pass Phrase is queried on the terminal and remembered for the next round (where it perhaps can be reused).

This scheme allows `mod_ssl` to be maximally flexible (because for N encrypted Private Key files you *can* use N different Pass Phrases - but then you have to enter all of them, of course) while minimizing the terminal dialog (i.e. when you use a single Pass Phrase for all N Private Key files this Pass Phrase is queried only once).

- `exec:/path/to/program`

Here an external program is configured which is called at startup for each encrypted Private Key file. It is called with two arguments (the first is of the form “`servername:portnumber`”, the second is either “`RSA`” or “`DSA`”), which indicate for which server and algorithm it has to print the corresponding Pass Phrase to

`stdout`. The intent is that this external program first runs security checks to make sure that the system is not compromised by an attacker, and only when these checks were passed successfully it provides the Pass Phrase.

Both these security checks, and the way the Pass Phrase is determined, can be as complex as you like. `Mod_ssl` just defines the interface: an executable program which provides the Pass Phrase on `stdout`. Nothing more or less! So, if you're really paranoid about security, here is your interface. Anything else has to be left as an exercise to the administrator, because local security requirements are so different.

The reuse-algorithm above is used here, too. In other words: The external program is called only once per unique Pass Phrase.

Example:

```
SSLPassPhraseDialog exec:/usr/local/apache/sbin/pp-filter
```

SSLProtocol Directive

Description:	Configure usable SSL protocol flavors
Syntax:	<code>SSLProtocol [+ -]protocol ...</code>
Default:	<code>SSLProtocol all</code>
Context:	server config, virtual host
Override:	Options
Status:	Extension
Module:	<code>mod_ssl</code>

This directive can be used to control the SSL protocol flavors `mod_ssl` should use when establishing its server environment. Clients then can only connect with one of the provided protocols.

The available (case-insensitive) *protocols* are:

- `SSLv2`
This is the Secure Sockets Layer (SSL) protocol, version 2.0. It is the original SSL protocol as designed by Netscape Corporation.
- `SSLv3`
This is the Secure Sockets Layer (SSL) protocol, version 3.0. It is the successor to `SSLv2` and the currently (as of February 1999) de-facto standardized SSL protocol from Netscape Corporation. It's supported by almost all popular browsers.
- `TLSv1`
This is the Transport Layer Security (TLS) protocol, version 1.0. It is the successor to `SSLv3` and currently (as of February 1999) still under construction by the Internet Engineering Task Force (IETF). It's still not supported by any popular browsers.
- `All`
This is a shortcut for “`+SSLv2 +SSLv3 +TLSv1`” and a convenient way for enabling all protocols except one when used in combination with the minus sign on a protocol as the example above shows.

Example

```
# enable SSLv3 and TLSv1, but not SSLv2
SSLProtocol all -SSLv2
```

SSLProxyCACertificateFile Directive

Description:	File of concatenated PEM-encoded CA Certificates for Remote Server Auth
Syntax:	SSLProxyCACertificateFile <i>file-path</i>
Context:	server config, virtual host
Status:	Extension
Module:	mod_ssl

This directive sets the *all-in-one* file where you can assemble the Certificates of Certification Authorities (CA) whose *remote servers* you deal with. These are used for Remote Server Authentication. Such a file is simply the concatenation of the various PEM-encoded Certificate files, in order of preference. This can be used alternatively and/or additionally to [SSLPROXYCACERTIFICATEPATH](#).

Example

```
SSLProxyCACertificateFile
/usr/local/apache2/conf/ssl.crt/ca-bundle-remote-server.crt
```

SSLProxyCACertificatePath Directive

Description:	Directory of PEM-encoded CA Certificates for Remote Server Auth
Syntax:	SSLProxyCACertificatePath <i>directory-path</i>
Context:	server config, virtual host
Status:	Extension
Module:	mod_ssl

This directive sets the directory where you keep the Certificates of Certification Authorities (CAs) whose remote servers you deal with. These are used to verify the remote server certificate on Remote Server Authentication.

The files in this directory have to be PEM-encoded and are accessed through hash filenames. So usually you can't just place the Certificate files there: you also have to create symbolic links named *hash-value.N*. And you should always make sure this directory contains the appropriate symbolic links. Use the *Makefile* which comes with *mod_ssl* to accomplish this task.

Example

```
SSLProxyCACertificatePath /usr/local/apache2/conf/ssl.crt/
```

SSLProxyCAREvocationFile Directive

Description:	File of concatenated PEM-encoded CA CRLs for Remote Server Auth
Syntax:	SSLProxyCAREvocationFile <i>file-path</i>
Context:	server config, virtual host
Status:	Extension
Module:	mod_ssl

This directive sets the *all-in-one* file where you can assemble the Certificate Revocation Lists (CRL) of Certification Authorities (CA) whose *remote servers* you deal with. These are used for Remote Server Authentication. Such a file is simply the concatenation of the various PEM-encoded CRL files, in order of preference. This can be used alternatively and/or additionally to [SSLPROXYCAREVOCATIONPATH](#).

Example

```
SSLProxyCAREvocationFile
/usr/local/apache2/conf/ssl.crl/ca-bundle-remote-server.crl
```

SSLProxyCARevocationPath Directive

Description:	Directory of PEM-encoded CA CRLs for Remote Server Auth
Syntax:	SSLProxyCARevocationPath <i>directory-path</i>
Context:	server config, virtual host
Status:	Extension
Module:	mod_ssl

This directive sets the directory where you keep the Certificate Revocation Lists (CRL) of Certification Authorities (CAs) whose remote servers you deal with. These are used to revoke the remote server certificate on Remote Server Authentication.

The files in this directory have to be PEM-encoded and are accessed through hash filenames. So usually you have not only to place the CRL files there. Additionally you have to create symbolic links named *hash-value*.rN. And you should always make sure this directory contains the appropriate symbolic links. Use the `Makefile` which comes with `MOD_SSL` to accomplish this task.

Example

```
SSLProxyCARevocationPath /usr/local/apache2/conf/ssl.crl/
```

SSLProxyCipherSuite Directive

Description:	Cipher Suite available for negotiation in SSL proxy handshake
Syntax:	SSLProxyCipherSuite <i>cipher-spec</i>
Default:	SSLProxyCipherSuite ALL:!ADH:RC4+RSA:+HIGH:+MEDIUM:+LOW:+SSLv2:+EXP
Context:	server config, virtual host, directory, .htaccess
Override:	AuthConfig
Status:	Extension
Module:	mod_ssl

Equivalent to `SSLCipherSuite`, but for the proxy connection. Please refer to `SSLCIPHERSUITE` for additional information.

SSLProxyEngine Directive

Description:	SSL Proxy Engine Operation Switch
Syntax:	SSLProxyEngine on off
Default:	SSLProxyEngine off
Context:	server config, virtual host
Status:	Extension
Module:	mod_ssl

This directive toggles the usage of the SSL/TLS Protocol Engine for proxy. This is usually used inside a `<VIRTU-ALHOST>` section to enable SSL/TLS for proxy usage in a particular virtual host. By default the SSL/TLS Protocol Engine is disabled for proxy image both for the main server and all configured virtual hosts.

Example

```
<VirtualHost _default_:443>
SSLProxyEngine on
...
</VirtualHost>
```

SSLProxyMachineCertificateFile Directive

Description:	File of concatenated PEM-encoded client certificates and keys to be used by the proxy
Syntax:	SSLProxyMachineCertificateFile <i>filename</i>
Context:	server config
Override:	Not applicable
Status:	Extension
Module:	mod_ssl

This directive sets the all-in-one file where you keep the certificates and keys used for authentication of the proxy server to remote servers.

This referenced file is simply the concatenation of the various PEM-encoded certificate files, in order of preference. Use this directive alternatively or additionally to `SSLProxyMachineCertificatePath`.



Currently there is no support for encrypted private keys

Example:

```
SSLProxyMachineCertificateFile
/usr/local/apache2/conf/ssl.crt/proxy.pem
```

SSLProxyMachineCertificatePath Directive

Description:	Directory of PEM-encoded client certificates and keys to be used by the proxy
Syntax:	SSLProxyMachineCertificatePath <i>directory</i>
Context:	server config
Override:	Not applicable
Status:	Extension
Module:	mod_ssl

This directive sets the directory where you keep the certificates and keys used for authentication of the proxy server to remote servers.

The files in this directory must be PEM-encoded and are accessed through hash filenames. Additionally, you must create symbolic links named `hash-value.N`. And you should always make sure this directory contains the appropriate symbolic links. Use the Makefile which comes with `mod_ssl` to accomplish this task.



Currently there is no support for encrypted private keys

Example:

```
SSLProxyMachineCertificatePath /usr/local/apache2/conf/proxy.crt/
```

SSLProxyProtocol Directive

Description:	Configure usable SSL protocol flavors for proxy usage
Syntax:	SSLProxyProtocol [+ -] <i>protocol</i> ...
Default:	SSLProxyProtocol all
Context:	server config, virtual host
Override:	Options
Status:	Extension
Module:	mod_ssl

This directive can be used to control the SSL protocol flavors `mod_ssl` should use when establishing its server environment for proxy . It will only connect to servers using one of the provided protocols.

Please refer to [SSLPROTOCOL](#) for additional information.

SSLProxyVerify Directive

Description:	Type of remote server Certificate verification
Syntax:	<code>SSLProxyVerify level</code>
Default:	<code>SSLProxyVerify none</code>
Context:	server config, virtual host, directory, <code>.htaccess</code>
Override:	<code>AuthConfig</code>
Status:	Extension
Module:	<code>mod_ssl</code>

This directive sets the Certificate verification level for the remote server Authentication. Notice that this directive can be used both in per-server and per-directory context. In per-server context it applies to the remote server authentication process used in the standard SSL handshake when a connection is established. In per-directory context it forces a SSL renegotiation with the reconfigured remote server verification level after the HTTP request was read but before the HTTP response is sent.

The following levels are available for *level*:

- **none**: no remote server Certificate is required at all
- **optional**: the remote server *may* present a valid Certificate
- **require**: the remote server *has to* present a valid Certificate
- **optional_no_ca**: the remote server may present a valid Certificate but it need not to be (successfully) verifiable.

In practice only levels **none** and **require** are really interesting, because level **optional** doesn't work with all servers and level **optional_no_ca** is actually against the idea of authentication (but can be used to establish SSL test pages, etc.)

Example

```
SSLProxyVerify require
```

SSLProxyVerifyDepth Directive

Description:	Maximum depth of CA Certificates in Remote Server Certificate verification
Syntax:	<code>SSLProxyVerifyDepth number</code>
Default:	<code>SSLProxyVerifyDepth 1</code>
Context:	server config, virtual host, directory, <code>.htaccess</code>
Override:	<code>AuthConfig</code>
Status:	Extension
Module:	<code>mod_ssl</code>

This directive sets how deeply `mod_ssl` should verify before deciding that the remote server does not have a valid certificate. Notice that this directive can be used both in per-server and per-directory context. In per-server context it applies to the client authentication process used in the standard SSL handshake when a connection is established. In per-directory context it forces a SSL renegotiation with the reconfigured remote server verification depth after the HTTP request was read but before the HTTP response is sent.

The depth actually is the maximum number of intermediate certificate issuers, i.e. the number of CA certificates which are max allowed to be followed while verifying the remote server certificate. A depth of 0 means that self-signed remote server certificates are accepted only, the default depth of 1 means the remote server certificate can be self-signed or has to be signed by a CA which is directly known to the server (i.e. the CA's certificate is under `SSLPROXYCACERTIFICATEPATH`), etc.

Example

```
SSLProxyVerifyDepth 10
```

SSLRandomSeed Directive

Description:	Pseudo Random Number Generator (PRNG) seeding source
Syntax:	SSLRandomSeed <i>context source [bytes]</i>
Context:	server config
Status:	Extension
Module:	mod_ssl

This configures one or more sources for seeding the Pseudo Random Number Generator (PRNG) in OpenSSL at startup time (*context* is `startup`) and/or just before a new SSL connection is established (*context* is `connect`). This directive can only be used in the global server context because the PRNG is a global facility.

The following *source* variants are available:

- `builtin` This is the always available builtin seeding source. It's usage consumes minimum CPU cycles under runtime and hence can be always used without drawbacks. The source used for seeding the PRNG contains of the current time, the current process id and (when applicable) a randomly chosen 1KB extract of the inter-process scoreboard structure of Apache. The drawback is that this is not really a strong source and at startup time (where the scoreboard is still not available) this source just produces a few bytes of entropy. So you should always, at least for the startup, use an additional seeding source.
- `file:/path/to/source`

This variant uses an external file `/path/to/source` as the source for seeding the PRNG. When *bytes* is specified, only the first *bytes* number of bytes of the file form the entropy (and *bytes* is given to `/path/to/source` as the first argument). When *bytes* is not specified the whole file forms the entropy (and 0 is given to `/path/to/source` as the first argument). Use this especially at startup time, for instance with an available `/dev/random` and/or `/dev/urandom` devices (which usually exist on modern Unix derivatives like FreeBSD and Linux).

But be careful: Usually `/dev/random` provides only as much entropy data as it actually has, i.e. when you request 512 bytes of entropy, but the device currently has only 100 bytes available two things can happen: On some platforms you receive only the 100 bytes while on other platforms the read blocks until enough bytes are available (which can take a long time). Here using an existing `/dev/urandom` is better, because it never blocks and actually gives the amount of requested data. The drawback is just that the quality of the received data may not be the best.

On some platforms like FreeBSD one can even control how the entropy is actually generated, i.e. by which system interrupts. More details one can find under `rndcontrol(8)` on those platforms. Alternatively, when your system lacks such a random device, you can use tool like EGD³³ (Entropy Gathering Daemon) and run it's client program with the `exec:/path/to/program/variant` (see below) or use `egd:/path/to/egd-socket` (see below).

- `exec:/path/to/program`

³³<http://www.lothar.com/tech/crypto/>

This variant uses an external executable `/path/to/program` as the source for seeding the PRNG. When `bytes` is specified, only the first `bytes` number of bytes of its `stdout` contents form the entropy. When `bytes` is not specified, the entirety of the data produced on `stdout` form the entropy. Use this only at startup time when you need a very strong seeding with the help of an external program (for instance as in the example above with the `truerand` utility you can find in the `mod_ssl` distribution which is based on the AT&T `truerand` library). Using this in the connection context slows down the server too dramatically, of course. So usually you should avoid using external programs in that context.

- `egd:/path/to/egd-socket` (Unix only)

This variant uses the Unix domain socket of the external Entropy Gathering Daemon (EGD) (see <http://www.lothar.com/tech/crypto/>³⁴) to seed the PRNG. Use this if no random device exists on your platform.

Example

```
SSLRandomSeed startup builtin
SSLRandomSeed startup file:/dev/random
SSLRandomSeed startup file:/dev/urandom 1024
SSLRandomSeed startup exec:/usr/local/bin/truerand 16
SSLRandomSeed connect builtin
SSLRandomSeed connect file:/dev/random
SSLRandomSeed connect file:/dev/urandom 1024
```

SSLRequire Directive

Description:	Allow access only when an arbitrarily complex boolean expression is true
Syntax:	<code>SSLRequire expression</code>
Context:	directory, <code>.htaccess</code>
Override:	<code>AuthConfig</code>
Status:	Extension
Module:	<code>mod_ssl</code>

This directive specifies a general access requirement which has to be fulfilled in order to allow access. It's a very powerful directive because the requirement specification is an arbitrarily complex boolean expression containing any number of access checks.

The *expression* must match the following syntax (given as a BNF grammar notation):

```
expr ::= "true" | "false"
      | "!" expr
      | expr "&&" expr
      | expr "||" expr
      | "(" expr ")"
      | comp

comp ::= word "==" word | word "eq" word
      | word "!=" word | word "ne" word
      | word "<" word | word "lt" word
      | word "<=" word | word "le" word
      | word ">" word | word "gt" word
      | word ">=" word | word "ge" word
      | word "in" "{" wordlist "}"
```

³⁴<http://www.lothar.com/tech/crypto/>

```

    | word "=~" regex
    | word "!~" regex

wordlist ::= word
         | wordlist "," word

word     ::= digit
         | cstring
         | variable
         | function

digit    ::= [0-9]+
cstring  ::= "... "
variable ::= "%{" varname "}"
function ::= funcname "(" funcargs ")"

```

while for varname any variable from Table 3 can be used. Finally for funcname the following functions are available:

- file (*filename*)

This function takes one string argument and expands to the contents of the file. This is especially useful for matching this contents against a regular expression, etc.

Notice that *expression* is first parsed into an internal machine representation and then evaluated in a second step. Actually, in Global and Per-Server Class context *expression* is parsed at startup time and at runtime only the machine representation is executed. For Per-Directory context this is different: here *expression* has to be parsed and immediately executed for every request.

Example

```

SSLRequire ( %{SSL.CIPHER} !~ m/^(EXP|NULL)-/ \
and %{SSL.CLIENT.S.DN.O} eq "Snake Oil, Ltd." \
and %{SSL.CLIENT.S.DN.OU} in {"Staff", "CA", "Dev"} \
and %{TIME.WDAY} >= 1 and %{TIME.WDAY} <= 5 \
and %{TIME.HOUR} >= 8 and %{TIME.HOUR} <= 20 ) \
or %{REMOTE.ADDR} =~ m/^192\.76\.162\.[0-9]+$/

```

Standard CGI/1.0 and Apache variables:

HTTP_USER_AGENT	PATH_INFO	AUTH_TYPE
HTTP_REFERER	QUERY_STRING	SERVER_SOFTWARE
HTTP_COOKIE	REMOTE_HOST	API_VERSION
HTTP_FORWARDED	REMOTE_IDENT	TIME_YEAR
HTTP_HOST	IS_SUBREQ	TIME_MON
HTTP_PROXY_CONNECTION	DOCUMENT_ROOT	TIME_DAY
HTTP_ACCEPT	SERVER_ADMIN	TIME_HOUR
HTTP:headername	SERVER_NAME	TIME_MIN
THE_REQUEST	SERVER_PORT	TIME_SEC
REQUEST_METHOD	SERVER_PROTOCOL	TIME_WDAY
REQUEST_SCHEME	REMOTE_ADDR	TIME
REQUEST_URI	REMOTE_USER	ENV:variablename
REQUEST_FILENAME		

SSL-related variables:

HTTPS	SSL_CLIENT_M_VERSION	SSL_SERVER_M_VERSION
	SSL_CLIENT_M_SERIAL	SSL_SERVER_M_SERIAL
SSL_PROTOCOL	SSL_CLIENT_V_START	SSL_SERVER_V_START
SSL_SESSION_ID	SSL_CLIENT_V_END	SSL_SERVER_V_END
SSL_CIPHER	SSL_CLIENT_S_DN	SSL_SERVER_S_DN
SSL_CIPHER_EXPORT	SSL_CLIENT_S_DN_C	SSL_SERVER_S_DN_C
SSL_CIPHER_ALGKEYSIZE	SSL_CLIENT_S_DN_ST	SSL_SERVER_S_DN_ST
SSL_CIPHER_USEKEYSIZE	SSL_CLIENT_S_DN_L	SSL_SERVER_S_DN_L
SSL_VERSION_LIBRARY	SSL_CLIENT_S_DN_O	SSL_SERVER_S_DN_O
SSL_VERSION_INTERFACE	SSL_CLIENT_S_DN_OU	SSL_SERVER_S_DN_OU
	SSL_CLIENT_S_DN_CN	SSL_SERVER_S_DN_CN
	SSL_CLIENT_S_DN_T	SSL_SERVER_S_DN_T
	SSL_CLIENT_S_DN_I	SSL_SERVER_S_DN_I
	SSL_CLIENT_S_DN_G	SSL_SERVER_S_DN_G
	SSL_CLIENT_S_DN_S	SSL_SERVER_S_DN_S
	SSL_CLIENT_S_DN_D	SSL_SERVER_S_DN_D
	SSL_CLIENT_S_DN_UID	SSL_SERVER_S_DN_UID
	SSL_CLIENT_S_DN_Email	SSL_SERVER_S_DN_Email
	SSL_CLIENT_I_DN	SSL_SERVER_I_DN
	SSL_CLIENT_I_DN_C	SSL_SERVER_I_DN_C
	SSL_CLIENT_I_DN_ST	SSL_SERVER_I_DN_ST
	SSL_CLIENT_I_DN_L	SSL_SERVER_I_DN_L
	SSL_CLIENT_I_DN_O	SSL_SERVER_I_DN_O
	SSL_CLIENT_I_DN_OU	SSL_SERVER_I_DN_OU
	SSL_CLIENT_I_DN_CN	SSL_SERVER_I_DN_CN
	SSL_CLIENT_I_DN_T	SSL_SERVER_I_DN_T
	SSL_CLIENT_I_DN_I	SSL_SERVER_I_DN_I
	SSL_CLIENT_I_DN_G	SSL_SERVER_I_DN_G
	SSL_CLIENT_I_DN_S	SSL_SERVER_I_DN_S
	SSL_CLIENT_I_DN_D	SSL_SERVER_I_DN_D
	SSL_CLIENT_I_DN_UID	SSL_SERVER_I_DN_UID
	SSL_CLIENT_I_DN_Email	SSL_SERVER_I_DN_Email
	SSL_CLIENT_A_SIG	SSL_SERVER_A_SIG
	SSL_CLIENT_A_KEY	SSL_SERVER_A_KEY
	SSL_CLIENT_CERT	SSL_SERVER_CERT
	SSL_CLIENT_CERT_CHAINn	
	SSL_CLIENT_VERIFY	

SSLRequireSSL Directive

Description:	Deny access when SSL is not used for the HTTP request
Syntax:	SSLRequireSSL
Context:	directory, .htaccess
Override:	AuthConfig
Status:	Extension
Module:	mod_ssl

This directive forbids access unless HTTP over SSL (i.e. HTTPS) is enabled for the current connection. This is very handy inside the SSL-enabled virtual host or directories for defending against configuration errors that expose stuff that should be protected. When this directive is present all requests are denied which are not using SSL.

Example

```
SSLRequireSSL
```

SSLSessionCache Directive

Description:	Type of the global/inter-process SSL Session Cache
Syntax:	SSLSessionCache <i>type</i>
Default:	SSLSessionCache none
Context:	server config
Status:	Extension
Module:	mod_ssl

This configures the storage type of the global/inter-process SSL Session Cache. This cache is an optional facility which speeds up parallel request processing. For requests to the same server process (via HTTP keep-alive), OpenSSL already caches the SSL session information locally. But because modern clients request inlined images and other data via parallel requests (usually up to four parallel requests are common) those requests are served by *different* pre-forked server processes. Here an inter-process cache helps to avoid unnecessary session handshakes.

The following two storage *types* are currently supported:

- none
This is the default and just disables the global/inter-process Session Cache. There is no drawback in functionality, but a noticeable speed penalty can be observed.
- dbm:/path/to/datafile
This makes use of a DBM hashfile on the local disk to synchronize the local OpenSSL memory caches of the server processes. The slight increase in I/O on the server results in a visible request speedup for your clients, so this type of storage is generally recommended.
- shm:/path/to/datafile[(*size*)]
This makes use of a high-performance hash table (approx. *size* bytes in size) inside a shared memory segment in RAM (established via /path/to/datafile) to synchronize the local OpenSSL memory caches of the server processes. This storage type is not available on all platforms.

Examples

```
SSLSessionCache dbm:/usr/local/apache/logs/ssl_gcach_data
SSLSessionCache shm:/usr/local/apache/logs/ssl_gcach_data(512000)
```

SSLSessionCacheTimeout Directive

Description:	Number of seconds before an SSL session expires in the Session Cache
Syntax:	SSLSessionCacheTimeout <i>seconds</i>
Default:	SSLSessionCacheTimeout 300
Context:	server config, virtual host
Status:	Extension
Module:	mod_ssl

This directive sets the timeout in seconds for the information stored in the global/inter-process SSL Session Cache and the OpenSSL internal memory cache. It can be set as low as 15 for testing, but should be set to higher values like 300 in real life.

Example

```
SSLSessionCacheTimeout 600
```

SSLUserName Directive

Description:	Variable name to determine user name
Syntax:	SSLUserName <i>varname</i>
Context:	server config, directory, .htaccess
Override:	AuthConfig
Status:	Extension
Module:	mod_ssl
Compatibility:	Available in Apache 2.0.51 and later

This directive sets the "user" field in the Apache request object. This is used by lower modules to identify the user with a character string. In particular, this may cause the environment variable `REMOTE_USER` to be set. The *varname* can be any of the SSL environment variables.

Example

```
SSLUserName SSL_CLIENT_S_DN_CN
```

SSLVerifyClient Directive

Description:	Type of Client Certificate verification
Syntax:	SSLVerifyClient <i>level</i>
Default:	SSLVerifyClient none
Context:	server config, virtual host, directory, .htaccess
Override:	AuthConfig
Status:	Extension
Module:	mod_ssl

This directive sets the Certificate verification level for the Client Authentication. Notice that this directive can be used both in per-server and per-directory context. In per-server context it applies to the client authentication process used in the standard SSL handshake when a connection is established. In per-directory context it forces a SSL renegotiation with the reconfigured client verification level after the HTTP request was read but before the HTTP response is sent.

The following levels are available for *level*:

- **none**: no client Certificate is required at all
- **optional**: the client *may* present a valid Certificate
- **require**: the client *has to* present a valid Certificate
- **optional_no_ca**: the client may present a valid Certificate but it need not to be (successfully) verifiable.

In practice only levels **none** and **require** are really interesting, because level **optional** doesn't work with all browsers and level **optional_no_ca** is actually against the idea of authentication (but can be used to establish SSL test pages, etc.)

Example

```
SSLVerifyClient require
```

SSLVerifyDepth Directive

Description:	Maximum depth of CA Certificates in Client Certificate verification
Syntax:	SSLVerifyDepth <i>number</i>
Default:	SSLVerifyDepth 1
Context:	server config, virtual host, directory, .htaccess
Override:	AuthConfig
Status:	Extension
Module:	mod_ssl

This directive sets how deeply mod_ssl should verify before deciding that the clients don't have a valid certificate. Notice that this directive can be used both in per-server and per-directory context. In per-server context it applies to the client authentication process used in the standard SSL handshake when a connection is established. In per-directory context it forces a SSL renegotiation with the reconfigured client verification depth after the HTTP request was read but before the HTTP response is sent.

The depth actually is the maximum number of intermediate certificate issuers, i.e. the number of CA certificates which are max allowed to be followed while verifying the client certificate. A depth of 0 means that self-signed client certificates are accepted only, the default depth of 1 means the client certificate can be self-signed or has to be signed by a CA which is directly known to the server (i.e. the CA's certificate is under [SSLCACERTIFICATEPATH](#)), etc.

Example

```
SSLVerifyDepth 10
```

10.54 Apache Module `mod_status`

Description:	Provides information on server activity and performance
Status:	Base
ModuleIdentifier:	<code>status_module</code>
SourceFile:	<code>mod_status.c</code>

Summary

The Status module allows a server administrator to find out how well their server is performing. A HTML page is presented that gives the current server statistics in an easily readable form. If required this page can be made to automatically refresh (given a compatible browser). Another page gives a simple machine-readable list of the current server state.

The details given are:

- The number of worker serving requests
- The number of idle worker
- The status of each worker, the number of requests that worker has performed and the total number of bytes served by the worker (*)
- A total number of accesses and byte count served (*)
- The time the server was started/restarted and the time it has been running for
- Averages giving the number of requests per second, the number of bytes served per second and the average number of bytes per request (*)
- The current percentage CPU used by each worker and in total by Apache (*)
- The current hosts and requests being processed (*)

The lines marked "(*)" are only available if `EXTENDEDSTATUS` is On.

Directives

- `ExtendedStatus`

Enabling Status Support

To enable status reports only for browsers from the `foo.com` domain add this code to your `httpd.conf` configuration file

```
<Location /server-status>
SetHandler server-status
Order Deny,Allow
Deny from all
Allow from .foo.com
</Location>
```

You can now access server statistics by using a Web browser to access the page `http://your.server.name/server-status`

Automatic Updates

You can get the status page to update itself automatically if you have a browser that supports "refresh". Access the page `http://your.server.name/server-status?refresh=N` to refresh the page every N seconds.

Machine Readable Status File

A machine-readable version of the status file is available by accessing the page `http://your.server.name/server-status?auto`. This is useful when automatically run, see the Perl program in the `/support` directory of Apache, `log_server_status`.

⇒ **It should be noted that if `MOD_STATUS` is compiled into the server, its handler capability is available in *all* configuration files, including *per-directory* files (e.g., `.htaccess`). This may have security-related ramifications for your site.**

ExtendedStatus Directive

Description:	Keep track of extended status information for each request
Syntax:	<code>ExtendedStatus On Off</code>
Default:	<code>ExtendedStatus Off</code>
Context:	server config
Status:	Base
Module:	<code>mod_status</code>
Compatibility:	<code>ExtendedStatus</code> is only available in Apache 1.3.2 and later.

This setting applies to the entire server, and cannot be enabled or disabled on a virtualhost-by-virtualhost basis. The collection of extended status information can slow down the server.

10.55 Apache Module `mod_suexec`

Description:	Allows CGI scripts to run as a specified user and Group
Status:	Extension
ModuleIdentifier:	<code>suexec_module</code>
SourceFile:	<code>mod_suexec.c</code>
Compatibility:	Available in Apache 2.0 and later

Summary

This module, in combination with the `suexec` support program allows CGI scripts to run as a specified user and Group.

Directives

- `SuexecUserGroup`

See also

- [SuEXEC support](#) (p. 68)

`SuexecUserGroup` Directive

Description:	User and group permissions for CGI programs
Syntax:	<code>SuexecUserGroup User Group</code>
Context:	server config, virtual host
Status:	Extension
Module:	<code>mod_suexec</code>
Compatibility:	<code>SuexecUserGroup</code> is only available in 2.0 and later.

The `SUEXECUSERGROUP` directive allows you to specify a user and group for CGI programs to run as. Non-CGI requests are still processes with the user specified in the `User` directive. This directive replaces the Apache 1.3 configuration of using the `User` and `Group` directives inside of `VirtualHosts`.

Example

```
SuexecUserGroup nobody nogroup
```

10.56 Apache Module mod_unique_id

Description:	Provides an environment variable with a unique identifier for each request
Status:	Extension
ModuleIdentifier:	unique_id_module
SourceFile:	mod_unique_id.c

Summary

This module provides a magic token for each request which is guaranteed to be unique across "all" requests under very specific conditions. The unique identifier is even unique across multiple machines in a properly configured cluster of machines. The environment variable `UNIQUE_ID` is set to the identifier for each request. Unique identifiers are useful for various reasons which are beyond the scope of this document.

Directives This module provides no directives.

Theory

First a brief recap of how the Apache server works on Unix machines. This feature currently isn't supported on Windows NT. On Unix machines, Apache creates several children, the children process requests one at a time. Each child can serve multiple requests in its lifetime. For the purpose of this discussion, the children don't share any data with each other. We'll refer to the children as httpd processes.

Your website has one or more machines under your administrative control, together we'll call them a cluster of machines. Each machine can possibly run multiple instances of Apache. All of these collectively are considered "the universe", and with certain assumptions we'll show that in this universe we can generate unique identifiers for each request, without extensive communication between machines in the cluster.

The machines in your cluster should satisfy these requirements. (Even if you have only one machine you should synchronize its clock with NTP.)

- The machines' times are synchronized via NTP or other network time protocol.
- The machines' hostnames all differ, such that the module can do a hostname lookup on the hostname and receive a different IP address for each machine in the cluster.

As far as operating system assumptions go, we assume that pids (process ids) fit in 32-bits. If the operating system uses more than 32-bits for a pid, the fix is trivial but must be performed in the code.

Given those assumptions, at a single point in time we can identify any httpd process on any machine in the cluster from all other httpd processes. The machine's IP address and the pid of the httpd process are sufficient to do this. So in order to generate unique identifiers for requests we need only distinguish between different points in time.

To distinguish time we will use a Unix timestamp (seconds since January 1, 1970 UTC), and a 16-bit counter. The timestamp has only one second granularity, so the counter is used to represent up to 65536 values during a single second. The quadruple (*ip_addr*, *pid*, *time_stamp*, *counter*) is sufficient to enumerate 65536 requests per second per httpd process. There are issues however with pid reuse over time, and the counter is used to alleviate this issue.

When an httpd child is created, the counter is initialized with (current microseconds divided by 10) modulo 65536 (this formula was chosen to eliminate some variance problems with the low order bits of the microsecond timers on some systems). When a unique identifier is generated, the time stamp used is the time the request arrived at the web server. The counter is incremented every time an identifier is generated (and allowed to roll over).

The kernel generates a pid for each process as it forks the process, and pids are allowed to roll over (they're 16-bits on many Unixes, but newer systems have expanded to 32-bits). So over time the same pid will be reused. However unless it is reused within the same second, it does not destroy the uniqueness of our quadruple. That is, we assume the

system does not spawn 65536 processes in a one second interval (it may even be 32768 processes on some Unices, but even this isn't likely to happen).

Suppose that time repeats itself for some reason. That is, suppose that the system's clock is screwed up and it revisits a past time (or it is too far forward, is reset correctly, and then revisits the future time). In this case we can easily show that we can get pid and time stamp reuse. The choice of initializer for the counter is intended to help defeat this. Note that we really want a random number to initialize the counter, but there aren't any readily available numbers on most systems (*i.e.*, you can't use `rand()` because you need to seed the generator, and can't seed it with the time because time, at least at one second resolution, has repeated itself). This is not a perfect defense.

How good a defense is it? Suppose that one of your machines serves at most 500 requests per second (which is a very reasonable upper bound at this writing, because systems generally do more than just shovel out static files). To do that it will require a number of children which depends on how many concurrent clients you have. But we'll be pessimistic and suppose that a single child is able to serve 500 requests per second. There are 1000 possible starting counter values such that two sequences of 500 requests overlap. So there is a 1.5% chance that if time (at one second resolution) repeats itself this child will repeat a counter value, and uniqueness will be broken. This was a very pessimistic example, and with real world values it's even less likely to occur. If your system is such that it's still likely to occur, then perhaps you should make the counter 32 bits (by editing the code).

You may be concerned about the clock being "set back" during summer daylight savings. However this isn't an issue because the times used here are UTC, which "always" go forward. Note that x86 based Unices may need proper configuration for this to be true – they should be configured to assume that the motherboard clock is on UTC and compensate appropriately. But even still, if you're running NTP then your UTC time will be correct very shortly after reboot.

The `UNIQUE_ID` environment variable is constructed by encoding the 112-bit (32-bit IP address, 32 bit pid, 32 bit time stamp, 16 bit counter) quadruple using the alphabet `[A-Za-z0-9@-]` in a manner similar to MIME base64 encoding, producing 19 characters. The MIME base64 alphabet is actually `[A-Za-z0-9+/-]` however `+` and `/` need to be specially encoded in URLs, which makes them less desirable. All values are encoded in network byte ordering so that the encoding is comparable across architectures of different byte ordering. The actual ordering of the encoding is: time stamp, IP address, pid, counter. This ordering has a purpose, but it should be emphasized that applications should not dissect the encoding. Applications should treat the entire encoded `UNIQUE_ID` as an opaque token, which can be compared against other `UNIQUE_IDs` for equality only.

The ordering was chosen such that it's possible to change the encoding in the future without worrying about collision with an existing database of `UNIQUE_IDs`. The new encodings should also keep the time stamp as the first element, and can otherwise use the same alphabet and bit length. Since the time stamps are essentially an increasing sequence, it's sufficient to have a *flag second* in which all machines in the cluster stop serving and request, and stop using the old encoding format. Afterwards they can resume requests and begin issuing the new encodings.

This we believe is a relatively portable solution to this problem. It can be extended to multithreaded systems like Windows NT, and can grow with future needs. The identifiers generated have essentially an infinite life-time because future identifiers can be made longer as required. Essentially no communication is required between machines in the cluster (only NTP synchronization is required, which is low overhead), and no communication between httpd processes is required (the communication is implicit in the pid value assigned by the kernel). In very specific situations the identifier can be shortened, but more information needs to be assumed (for example the 32-bit IP address is overkill for any site, but there is no portable shorter replacement for it).

10.57 Apache Module mod_userdir

Description:	User-specific directories
Status:	Base
ModuleIdentifier:	userdir_module
SourceFile:	mod_userdir.c

Summary

This module allows user-specific directories to be accessed using the `http://example.com/~user/` syntax.

Directives

- UserDir

See also

- Mapping URLs to the Filesystem (p. 36)
- public_html tutorial (p. 202)

UserDir Directive

Description:	Location of the user-specific directories
Syntax:	UserDir <i>directory-filename</i>
Default:	UserDir public_html
Context:	server config, virtual host
Status:	Base
Module:	mod_userdir

The **USERDIR** directive sets the real directory in a user's home directory to use when a request for a document for a user is received. *Directory-filename* is one of the following:

- The name of a directory or a pattern such as those shown below.
- The keyword `disabled`. This turns off *all* username-to-directory translations except those explicitly named with the `enabled` keyword (see below).
- The keyword `disabled` followed by a space-delimited list of usernames. Usernames that appear in such a list will *never* have directory translation performed, even if they appear in an `enabled` clause.
- The keyword `enabled` followed by a space-delimited list of usernames. These usernames will have directory translation performed even if a global disable is in effect, but not if they also appear in a `disabled` clause.

If neither the `enabled` nor the `disabled` keywords appear in the `Userdir` directive, the argument is treated as a filename pattern, and is used to turn the name into a directory specification. A request for `http://www.foo.com/~bob/one/two.html` will be translated to:

UserDir directive used	Translated path
UserDir public_html	~bob/public_html/one/two.html
UserDir /usr/web	/usr/web/bob/one/two.html
UserDir /home/*/www	/home/bob/www/one/two.html

The following directives will send redirects to the client:

UserDir directive used	Translated path
UserDir http://www.foo.com/users	http://www.foo.com/users/bob/one/two.html
UserDir http://www.foo.com/*usr	http://www.foo.com/bob/usr/one/two.html
UserDir http://www.foo.com/~*/	http://www.foo.com/~bob/one/two.html

⇒ **Be careful when using this directive; for instance, "UserDir ./" would map "~/root" to "/" - which is probably undesirable. It is strongly recommended that your configuration include a "UserDir disabled root" declaration. See also the [DIRECTORY](#) directive and the Security Tips (p. 40) page for more information.**

Additional examples:

To allow a few users to have UserDir directories, but not anyone else, use the following:

```
UserDir disabled
UserDir enabled user1 user2 user3
```

To allow most users to have UserDir directories, but deny this to a few, use the following:

```
UserDir enabled
UserDir disabled user4 user5 user6
```

It is also possible to specify alternative user directories. If you use a command like:

```
Userdir public_html /usr/web http://www.foo.com/
```

With a request for `http://www.foo.com/~bob/one/two.html`, will try to find the page at `~bob/public_html/one/two.html` first, then `/usr/web/bob/one/two.html`, and finally it will send a redirect to `http://www.foo.com/bob/one/two.html`.

If you add a redirect, it must be the last alternative in the list. Apache cannot determine if the redirect succeeded or not, so if you have the redirect earlier in the list, that will always be the alternative that is used.

See also

- [public_html tutorial](#) (p. 202)

10.58 Apache Module mod_usertrack

Description:	<i>Clickstream</i> logging of user activity on a site
Status:	Extension
ModuleIdentifier:	usertrack_module
SourceFile:	mod_usertrack.c

Summary

Previous releases of Apache have included a module which generates a 'clickstream' log of user activity on a site using cookies. This was called the "cookies" module, mod_cookies. In Apache 1.2 and later this module has been renamed the "user tracking" module, mod_usertrack. This module has been simplified and new directives added.

Directives

- CookieDomain
- CookieExpires
- CookieName
- CookieStyle
- CookieTracking

Logging

Previously, the cookies module (now the user tracking module) did its own logging, using the [COOKIELOG](#) directive. In this release, this module does no logging at all. Instead, a configurable log format file should be used to log user click-streams. This is possible because the logging module now allows multiple log files. The cookie itself is logged by using the text `%{cookie}n` in the log file format. For example:

```
CustomLog logs/clickstream "%{cookie}n %r %t"
```

For backward compatibility the configurable log module implements the old [COOKIELOG](#) directive, but this should be upgraded to the above [CUSTOMLOG](#) directive.

2-digit or 4-digit dates for cookies?

(the following is from message <022701bda43d\$9d32bbb0\$1201a8c0@christian.office.sane.com> in the new-httpd archives)

```
From: "Christian Allen" <christian@sane.com>  
Subject: Re: Apache Y2K bug in mod_usertrack.c  
Date: Tue, 30 Jun 1998 11:41:56 -0400
```

Did some work with cookies and dug up some info that might be useful.

True, Netscape claims that the correct format NOW is four digit dates, and four digit dates do in fact work... for Netscape 4.x (Communicator), that is. However, 3.x and below do NOT accept them. It seems that Netscape

originally had a 2-digit standard, and then with all of the Y2K hype and probably a few complaints, changed to a four digit date for Communicator. Fortunately, 4.x also understands the 2-digit format, and so the best way to ensure that your expiration date is legible to the client's browser is to use 2-digit dates.

However, this does not limit expiration dates to the year 2000; if you use an expiration year of "13", for example, it is interpreted as 2013, NOT 1913! In fact, you can use an expiration year of up to "37", and it will be understood as "2037" by both MSIE and Netscape versions 3.x and up (not sure about versions previous to those). Not sure why Netscape used that particular year as its cut-off point, but my guess is that it was in respect to UNIX's 2038 problem. Netscape/MSIE 4.x seem to be able to understand 2-digit years beyond that, at least until "50" for sure (I think they understand up until about "70", but not for sure).

Summary: Mozilla 3.x and up understands two digit dates up until "37" (2037). Mozilla 4.x understands up until at least "50" (2050) in 2-digit form, but also understands 4-digit years, which can probably reach up until 9999. Your best bet for sending a long-life cookie is to send it for some time late in the year "37".

CookieDomain Directive

Description:	The domain to which the tracking cookie applies
Syntax:	CookieDomain <i>domain</i>
Context:	server config, virtual host, directory, .htaccess
Override:	FileInfo
Status:	Extension
Module:	mod_usertrack

This directive controls the setting of the domain to which the tracking cookie applies. If not present, no domain is included in the cookie header field.

The domain string **must** begin with a dot, and **must** include at least one embedded dot. That is, `.foo.com` is legal, but `foo.bar.com` and `.com` are not.

⇒ Most browsers in use today will not allow cookies to be set for a two-part top level domain, such as `.co.uk`, although such a domain ostensibly fulfills the requirements above.

These domains are equivalent to top level domains such as `.com`, and allowing such cookies may be a security risk. Thus, if you are under a two-part top level domain, you should still use your actual domain, as you would with any other top level domain (for example, use `.foo.co.uk`).

CookieExpires Directive

Description:	Expiry time for the tracking cookie
Syntax:	CookieExpires <i>expiry-period</i>
Context:	server config, virtual host, directory, .htaccess
Override:	FileInfo
Status:	Extension
Module:	mod_usertrack

When used, this directive sets an expiry time on the cookie generated by the usertrack module. The *expiry-period* can be given either as a number of seconds, or in the format such as "2 weeks 3 days 7 hours". Valid denominations are: years, months, weeks, days, hours, minutes and seconds. If the expiry time is in any format other than one number indicating the number of seconds, it must be enclosed by double quotes.

If this directive is not used, cookies last only for the current browser session.

CookieName Directive

Description:	Name of the tracking cookie
Syntax:	CookieName <i>token</i>
Default:	CookieName Apache
Context:	server config, virtual host, directory, .htaccess
Override:	FileInfo
Status:	Extension
Module:	mod_usertrack

This directive allows you to change the name of the cookie this module uses for its tracking purposes. By default the cookie is named "Apache".

You must specify a valid cookie name; results are unpredictable if you use a name containing unusual characters. Valid characters include A-Z, a-z, 0-9, "_", and "-".

CookieStyle Directive

Description:	Format of the cookie header field
Syntax:	CookieStyle <i>Netscape Cookie Cookie2 RFC2109 RFC2965</i>
Default:	CookieStyle Netscape
Context:	server config, virtual host, directory, .htaccess
Override:	FileInfo
Status:	Extension
Module:	mod_usertrack

This directive controls the format of the cookie header field. The three formats allowed are:

- **Netscape**, which is the original but now deprecated syntax. This is the default, and the syntax Apache has historically used.
- **Cookie** or **RFC2109**, which is the syntax that superseded the Netscape syntax.
- **Cookie2** or **RFC2965**, which is the most current cookie syntax.

Not all clients can understand all of these formats. but you should use the newest one that is generally acceptable to your users' browsers. At the time of writing, most browsers only fully support `CookieStyle Netscape`.

CookieTracking Directive

Description:	Enables tracking cookie
Syntax:	CookieTracking <i>on off</i>
Default:	CookieTracking <i>off</i>
Context:	server config, virtual host, directory, .htaccess
Override:	FileInfo
Status:	Extension
Module:	mod_usertrack

When `MOD_USERTRACK` is loaded, and `CookieTracking on` is set, Apache will send a user-tracking cookie for all new requests. This directive can be used to turn this behavior on or off on a per-server or per-directory basis. By default, enabling `MOD_USERTRACK` will **not** activate cookies.

10.59 Apache Module mod_version

Description:	Version dependent configuration
Status:	Extension
ModuleIdentifier:	version_module
SourceFile:	mod_version.c
Compatibility:	Available in version 2.0.56 and later

Summary

This module is designed for the use in test suites and large networks which have to deal with different httpd versions and different configurations. It provides a new container – `<IfVersion>`, which allows a flexible version checking including numeric comparisons and regular expressions.

Examples

```
<IfVersion 2.1.0>
  # current httpd version is exactly 2.1.0
</IfVersion>
<IfVersion >= 2.2>
  # use really new features :-)
</IfVersion>
```

See below for further possibilities.

Directives

- `<IfVersion>`

IfVersion Directive

Description:	contains version dependent configuration
Syntax:	<code><IfVersion [[!]operator] version> ... </IfVersion></code>
Context:	server config, virtual host, directory, .htaccess
Override:	All
Status:	Extension
Module:	mod_version

The `<IfVersion>` section encloses configuration directives which are executed only if the httpd version matches the desired criteria. For normal (numeric) comparisons the version argument has the format `major[.minor[.patch]]`, e.g. `2.1.0` or `2.2`. `minor` and `patch` are optional. If these numbers are omitted, they are assumed to be zero. The following numerical operators are possible:

operator	description
<code>= or ==</code>	httpd version is equal
<code>></code>	httpd version is greater than
<code>>=</code>	httpd version is greater or equal
<code><</code>	httpd version is less than
<code><=</code>	httpd version is less or equal

Example

```
<IfVersion >= 2.1>
  # this happens only in versions greater or
  # equal 2.1.0.
</IfVersion>
```

Besides the numerical comparison it is possible to match a regular expression against the httpd version. There are two ways to write it:

operator	description
= or ==	version has the form <code>/regex/</code>
~	version has the form <code>regex</code>

Example

```
<IfVersion = /^2.1.[01234]$/>
  # e.g. workaround for buggy versions
</IfVersion>
```

In order to reverse the meaning, all operators can be preceded by an exclamation mark (!):

```
<IfVersion !~ ^2.1.[01234]$/>
  # not for those versions
</IfVersion>
```

If the operator is omitted, it is assumed to be =.

10.60 Apache Module mod_vhost_alias

Description:	Provides for dynamically configured mass virtual hosting
Status:	Extension
ModuleIdentifier:	vhost_alias_module
SourceFile:	mod_vhost_alias.c

Summary

This module creates dynamically configured virtual hosts, by allowing the IP address and/or the `Host :` header of the HTTP request to be used as part of the pathname to determine what files to serve. This allows for easy use of a huge number of virtual hosts with similar configurations.

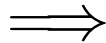

Note

If [MOD_ALIAS](#) or [MOD_USERDIR](#) are used for translating URIs to filenames, they will override the directives of [MOD_VHOST_ALIAS](#) described below. For example, the following configuration will map `/cgi-bin/script.pl` to `/usr/local/apache2/cgi-bin/script.pl` in all cases:

```
ScriptAlias /cgi-bin/ /usr/local/apache2/cgi-bin/
VirtualScriptAlias /never/found/%0/cgi-bin/
```

Directives

- `VirtualDocumentRoot`
- `VirtualDocumentRootIP`
- `VirtualScriptAlias`
- `VirtualScriptAliasIP`

See also

- [USECANONICALNAME](#)
- Dynamically configured mass virtual hosting (p. 116)

Directory Name Interpolation

All the directives in this module interpolate a string into a pathname. The interpolated string (henceforth called the "name") may be either the server name (see the [USECANONICALNAME](#) directive for details on how this is determined) or the IP address of the virtual host on the server in dotted-quad format. The interpolation is controlled by specifiers inspired by `printf` which have a number of formats:

<code>%%</code>	insert a <code>%</code>
<code>%p</code>	insert the port number of the virtual host
<code>%N.M</code>	insert (part of) the name

`N` and `M` are used to specify substrings of the name. `N` selects from the dot-separated components of the name, and `M` selects characters within whatever `N` has selected. `M` is optional and defaults to zero if it isn't present; the dot must be present if and only if `M` is present. The interpretation is as follows:

0	the whole name
1	the first part
2	the second part
-1	the last part
-2	the penultimate part
2+	the second and all subsequent parts
-2+	the penultimate and all preceding parts
1+ and -1+	the same as 0

If N or M is greater than the number of parts available a single underscore is interpolated.

Examples

For simple name-based virtual hosts you might use the following directives in your server configuration file:

```
UseCanonicalName Off
VirtualDocumentRoot /usr/local/apache/vhosts/%0
```

A request for `http://www.example.com/directory/file.html` will be satisfied by the file `/usr/local/apache/vhosts/www.example.com/directory/file.html`.

For a very large number of virtual hosts it is a good idea to arrange the files to reduce the size of the `vhosts` directory. To do this you might use the following in your configuration file:

```
UseCanonicalName Off
VirtualDocumentRoot /usr/local/apache/vhosts/%3+/%2.1/%2.2/%2.3/%2
```

A request for `http://www.domain.example.com/directory/file.html` will be satisfied by the file `/usr/local/apache/vhosts/example.com/d/o/m/domain/directory/file.html`.

A more even spread of files can be achieved by hashing from the end of the name, for example:

```
VirtualDocumentRoot /usr/local/apache/vhosts/%3+/%2.-1/%2.-2/%2.-3/%2
```

The example request would come from `/usr/local/apache/vhosts/example.com/n/i/a/domain/directory/file`

Alternatively you might use:

```
VirtualDocumentRoot /usr/local/apache/vhosts/%3+/%2.1/%2.2/%2.3/%2.4+
```

The example request would come from `/usr/local/apache/vhosts/example.com/d/o/m/ain/directory/file.htm`

For IP-based virtual hosting you might use the following in your configuration file:

```
UseCanonicalName DNS
VirtualDocumentRootIP /usr/local/apache/vhosts/%1/%2/%3/%4/docs
VirtualScriptAliasIP /usr/local/apache/vhosts/%1/%2/%3/%4/cgi-bin
```

A request for `http://www.domain.example.com/directory/file.html` would be satisfied by the file `/usr/local/apache/vhosts/10/20/30/40/docs/directory/file.html` if the IP address of `www.domain.example.com` were `10.20.30.40`. A request for

`http://www.domain.example.com/cgi-bin/script.pl` would be satisfied by executing the program `/usr/local/apache/vhosts/10/20/30/40/cgi-bin/script.pl`.

If you want to include the `.` character in a `VirtualDocumentRoot` directive, but it clashes with a `%` directive, you can work around the problem in the following way:

```
VirtualDocumentRoot /usr/local/apache/vhosts/%2.0.%3.0
```

A request for `http://www.domain.example.com/directory/file.html` will be satisfied by the file `/usr/local/apache/vhosts/domain.example/directory/file.html`.

The **LOGFORMAT** directives `%V` and `%A` are useful in conjunction with this module.

VirtualDocumentRoot Directive

Description:	Dynamically configure the location of the document root for a given virtual host
Syntax:	<code>VirtualDocumentRoot <i>interpolated-directory</i> none</code>
Default:	<code>VirtualDocumentRoot none</code>
Context:	server config, virtual host
Status:	Extension
Module:	<code>mod_vhost_alias</code>

The **VIRTUALDOCUMENTROOT** directive allows you to determine where Apache will find your documents based on the value of the server name. The result of expanding *interpolated-directory* is used as the root of the document tree in a similar manner to the **DOCUMENTROOT** directive's argument. If *interpolated-directory* is `none` then **VIRTUALDOCUMENTROOT** is turned off. This directive cannot be used in the same context as **VIRTUALDOCUMENTROOTIP**.

VirtualDocumentRootIP Directive

Description:	Dynamically configure the location of the document root for a given virtual host
Syntax:	<code>VirtualDocumentRootIP <i>interpolated-directory</i> none</code>
Default:	<code>VirtualDocumentRootIP none</code>
Context:	server config, virtual host
Status:	Extension
Module:	<code>mod_vhost_alias</code>

The **VIRTUALDOCUMENTROOTIP** directive is like the **VIRTUALDOCUMENTROOT** directive, except that it uses the IP address of the server end of the connection for directory interpolation instead of the server name.

VirtualScriptAlias Directive

Description:	Dynamically configure the location of the CGI directory for a given virtual host
Syntax:	<code>VirtualScriptAlias <i>interpolated-directory</i> none</code>
Default:	<code>VirtualScriptAlias none</code>
Context:	server config, virtual host
Status:	Extension
Module:	<code>mod_vhost_alias</code>

The **VIRTUALSCRIPTALIAS** directive allows you to determine where Apache will find CGI scripts in a similar manner to **VIRTUALDOCUMENTROOT** does for other documents. It matches requests for URIs starting `/cgi-bin/`, much like **SCRIPTALIAS** `/cgi-bin/` would.

VirtualScriptAliasIP Directive

Description:	Dynamically configure the location of the cgi directory for a given virtual host
Syntax:	VirtualScriptAliasIP <i>interpolated-directory</i> none
Default:	VirtualScriptAliasIP none
Context:	server config, virtual host
Status:	Extension
Module:	mod_vhost_alias

The [VIRTUALSCRIPTALIASIP](#) directive is like the [VIRTUALSCRIPTALIAS](#) directive, except that it uses the IP address of the server end of the connection for directory interpolation instead of the server name.

10.61 Apache Module beos

Description:	This Multi-Processing Module is optimized for BeOS.
Status:	MPM
ModuleIdentifier:	mpm_beos_module
SourceFile:	beos.c

Summary

This Multi-Processing Module (MPM) is the default for BeOS. It uses a single control process which creates threads to handle requests.

Directives

- [CoreDumpDirectory](#) (p. 592)
- [Group](#) (p. 593)
- [Listen](#) (p. 594)
- [ListenBacklog](#) (p. 594)
- [MaxClients](#) (p. 595)
- [MaxMemFree](#) (p. 596)
- [MaxRequestsPerThread](#)
- [MaxSpareThreads](#) (p. 596)
- [MinSpareThreads](#) (p. 597)
- [PidFile](#) (p. 598)
- [ReceiveBufferSize](#) (p. 598)
- [ScoreBoardFile](#) (p. 598)
- [SendBufferSize](#) (p. 599)
- [StartThreads](#) (p. 600)
- [User](#) (p. 601)

See also

- [Setting which addresses and ports Apache uses](#) (p. 57)

MaxRequestsPerThread Directive

Description:	Limit on the number of requests that an individual thread will handle during its life
Syntax:	<code>MaxRequestsPerThread number</code>
Default:	<code>MaxRequestsPerThread 0</code>
Context:	server config
Status:	MPM
Module:	beos

The [MAXREQUESTSPERTHREAD](#) directive sets the limit on the number of requests that an individual server thread will handle. After [MAXREQUESTSPERTHREAD](#) requests, the thread will die. If [MAXREQUESTSPERTHREAD](#) is 0, then the thread will never expire.

Setting [MAXREQUESTSPERTHREAD](#) to a non-zero limit has two beneficial effects:

- it limits the amount of memory that a thread can consume by (accidental) memory leakage;
- by giving threads a finite lifetime, it helps reduce the number of threads when the server load reduces.

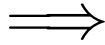
**Note:**

For **KEEPALIVE** requests, only the first request is counted towards this limit. In effect, it changes the behavior to limit the number of *connections* per thread.

10.62 Apache Module `mpm_common`

Description:	A collection of directives that are implemented by more than one multi-processing module (MPM)
Status:	MPM

Directives

- `AcceptMutex`
- `BS2000Account`
- `CoreDumpDirectory`
- `EnableExceptionHook`
- `Group`
- `Listen`
- `ListenBackLog`
- `LockFile`
- `MaxClients`
- `MaxMemFree`
- `MaxRequestsPerChild`
- `MaxSpareThreads`
- `MinSpareThreads`
- `PidFile`
- `ReceiveBufferSize`
- `ScoreBoardFile`
- `SendBufferSize`
- `ServerLimit`
- `StartServers`
- `StartThreads`
- `ThreadLimit`
- `ThreadsPerChild`
- `User`

AcceptMutex Directive

Description:	Method that Apache uses to serialize multiple children accepting requests on network sockets
Syntax:	<code>AcceptMutex Default method</code>
Default:	<code>AcceptMutex Default</code>
Context:	server config
Status:	MPM
Module:	LEADER , PERCHILD , PREFORK , THREADPOOL , WORKER

The `ACCEPTMUTEX` directive sets the method that Apache uses to serialize multiple children accepting requests on network sockets. Prior to Apache 2.0, the method was selectable only at compile time. The optimal method to use is highly architecture and platform dependent. For further details, see the performance tuning (p. 73) documentation.

If this directive is set to `Default`, then the compile-time selected default will be used. Other possible methods are listed below. Note that not all methods are available on all platforms. If a method is specified which is not available, a message will be written to the error log listing the available methods.

flock uses the `flock(2)` system call to lock the file defined by the `LOCKFILE` directive.

fcntl uses the `fcntl(2)` system call to lock the file defined by the `LOCKFILE` directive.

posixsem uses POSIX compatible semaphores to implement the mutex.

pthread uses POSIX mutexes as implemented by the POSIX Threads (PThreads) specification.

sysvsem uses SysV-style semaphores to implement the mutex.

If you want to find out the compile time chosen default for your system, you may set your `LOGLEVEL` to `debug`. Then the default `ACCEPTMUTEX` will be written into the `ERRORLOG`.

BS2000Account Directive

Description:	Define the non-privileged account on BS2000 machines
Syntax:	<code>BS2000Account account</code>
Context:	server config
Status:	MPM
Module:	PERCHILD , PREFORK
Compatibility:	Only available for BS2000 machines

The `BS2000ACCOUNT` directive is available for BS2000 hosts only. It must be used to define the account number for the non-privileged apache server user (which was configured using the `USER` directive). This is required by the BS2000 POSIX subsystem (to change the underlying BS2000 task environment by performing a sub-LOGON) to prevent CGI scripts from accessing resources of the privileged account which started the server, usually `SYSROOT`.

⇒ Note

Only one `BS2000Account` directive can be used.

See also

- Apache EBCDIC port (p. 230)

CoreDumpDirectory Directive

Description:	Directory where Apache attempts to switch before dumping core
Syntax:	<code>CoreDumpDirectory directory</code>
Default:	See usage for the default setting
Context:	server config
Status:	MPM
Module:	BEOS , LEADER , MPM_WINNT , PERCHILD , PREFORK , THREADPOOL , WORKER

This controls the directory to which Apache attempts to switch before dumping core. The default is in the `SERVER-ROOT` directory, however since this should not be writable by the user the server runs as, core dumps won't normally get written. If you want a core dump for debugging, you can use this directive to place it in a different location.

⇒ Core Dumps on Linux

If Apache starts as root and switches to another user, the Linux kernel *disables* core dumps even if the directory is writable for the process. Apache (2.0.46 and later) reenables core dumps on Linux 2.4 and beyond, but only if you explicitly configure a `COREDUMPDIRECTORY`.

EnableExceptionHook Directive

Description:	Enables a hook that runs exception handlers after a crash
Syntax:	EnableExceptionHook On Off
Default:	EnableExceptionHook Off
Context:	server config
Status:	MPM
Module:	LEADER , PERCHILD , PREFORK , THREADPOOL , WORKER
Compatibility:	Available in version 2.0.49 and later

For safety reasons this directive is only available if the server was configured with the `--enable-exception-hook` option. It enables a hook that allows external modules to plug in and do something after a child crashed.

There are already two modules, `mod_whatkilledus` and `mod_backtrace` that make use of this hook. Please have a look at Jeff Trawick's [EnableExceptionHook site](#)³⁵ for more information about these.

Group Directive

Description:	Group under which the server will answer requests
Syntax:	Group unix-group
Default:	Group #-1
Context:	server config
Status:	MPM
Module:	BEOS , LEADER , MPMT_OS2 , PERCHILD , PREFORK , THREADPOOL , WORKER
Compatibility:	Only valid in global server config since Apache 2.0

The **GROUP** directive sets the group under which the server will answer requests. In order to use this directive, the server must be run initially as `root`. If you start the server as a non-root user, it will fail to change to the specified group, and will instead continue to run as the group of the original user. Unix-group is one of:

A group name Refers to the given group by name.

followed by a group number. Refers to a group by its number.

Example

```
Group www-group
```

It is recommended that you set up a new group specifically for running the server. Some admins use user `nobody`, but this is not always possible or desirable.



Security

Don't set **GROUP** (or **USER**) to `root` unless you know exactly what you are doing, and what the dangers are.

Special note: Use of this directive in `<VIRTUALHOST>` is no longer supported. To configure your server for `suexec` use `SUEXECUSERGROUP`.

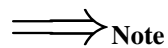

Note

Although the **GROUP** directive is present in the [BEOS](#) and [MPMT_OS2](#) MPMs, it is actually a no-op there and only exists for compatibility reasons.

³⁵http://www.apache.org/~trawick/exception_hook.html

Listen Directive

Description:	IP addresses and ports that the server listens to
Syntax:	<code>Listen [IP-address:]portnumber</code>
Context:	server config
Status:	MPM
Module:	BEOS , LEADER , MPM_NETWORK , MPM_WINNT , MPMT_OS2 , PERCHILD , PREFORK , THREAD-POOL , WORKER
Compatibility:	Required directive since Apache 2.0

The `LISTEN` directive instructs Apache to listen to only specific IP addresses or ports; by default it responds to requests on all IP interfaces. `LISTEN` is now a required directive. If it is not in the config file, the server will fail to start. This is a change from previous versions of Apache.

The `LISTEN` directive tells the server to accept incoming requests on the specified port or address-and-port combination. If only a port number is specified, the server listens to the given port on all interfaces. If an IP address is given as well as a port, the server will listen on the given port and interface.

Multiple `LISTEN` directives may be used to specify a number of addresses and ports to listen to. The server will respond to requests from any of the listed addresses and ports.

For example, to make the server accept connections on both port 80 and port 8000, use:

```
Listen 80
Listen 8000
```

To make the server accept connections on two specified interfaces and port numbers, use

```
Listen 192.170.2.1:80
Listen 192.170.2.5:8000
```

IPv6 addresses must be surrounded in square brackets, as in the following example:

```
Listen [2001:db8::a00:20ff:fea7:ccea]:80
```

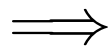

Error condition

Multiple `LISTEN` directives for the same ip address and port will result in an `Address already in use` error message.

See also

- [DNS Issues](#) (p. 136)
- [Setting which addresses and ports Apache uses](#) (p. 57)

ListenBackLog Directive

Description:	Maximum length of the queue of pending connections
Syntax:	<code>ListenBacklog backlog</code>
Default:	<code>ListenBacklog 511</code>
Context:	server config
Status:	MPM
Module:	BEOS , LEADER , MPM_NETWORK , MPM_WINNT , MPMT_OS2 , PERCHILD , PREFORK , THREAD-POOL , WORKER

The maximum length of the queue of pending connections. Generally no tuning is needed or desired, however on some systems it is desirable to increase this when under a TCP SYN flood attack. See the `backlog` parameter to the `listen(2)` system call.

This will often be limited to a smaller number by the operating system. This varies from OS to OS. Also note that many OSes do not use exactly what is specified as the backlog, but use a number based on (but normally larger than) what is set.

LockFile Directive

Description:	Location of the accept serialization lock file
Syntax:	<code>LockFile filename</code>
Default:	<code>LockFile logs/accept.lock</code>
Context:	server config
Status:	MPM
Module:	LEADER , PERCHILD , PREFORK , THREADPOOL , WORKER

The [LOCKFILE](#) directive sets the path to the lockfile used when Apache is used with an [ACCEPTMUTEX](#) value of either `fcntl` or `flock`. This directive should normally be left at its default value. The main reason for changing it is if the `logs` directory is NFS mounted, since **the lockfile must be stored on a local disk**. The PID of the main server process is automatically appended to the filename.



Security

It is best to *avoid* putting this file in a world writable directory such as `/var/tmp` because someone could create a denial of service attack and prevent the server from starting by creating a lockfile with the same name as the one the server will try to create.

See also

- [ACCEPTMUTEX](#)

MaxClients Directive

Description:	Maximum number of child processes that will be created to serve requests
Syntax:	<code>MaxClients number</code>
Default:	See usage for details
Context:	server config
Status:	MPM
Module:	BEOS , LEADER , PREFORK , THREADPOOL , WORKER

The [MAXCLIENTS](#) directive sets the limit on the number of simultaneous requests that will be served. Any connection attempts over the [MAXCLIENTS](#) limit will normally be queued, up to a number based on the [LISTENBACKLOG](#) directive. Once a child process is freed at the end of a different request, the connection will then be serviced.

For non-threaded servers (*i.e.*, [PREFORK](#)), [MAXCLIENTS](#) translates into the maximum number of child processes that will be launched to serve requests. The default value is 256; to increase it, you must also raise [SERVERLIMIT](#).

For threaded and hybrid servers (*e.g.* [BEOS](#) or [WORKER](#)) [MAXCLIENTS](#) restricts the total number of threads that will be available to serve clients. The default value for [BEOS](#) is 50. For hybrid MPMs the default value is 16 ([SERVERLIMIT](#)) multiplied by the value of 25 ([THREADSPERCHILD](#)). Therefore, to increase [MAXCLIENTS](#) to a value that requires more than 16 processes, you must also raise [SERVERLIMIT](#).

MaxMemFree Directive

Description:	Maximum amount of memory that the main allocator is allowed to hold without calling <code>free()</code>
Syntax:	<code>MaxMemFree KBytes</code>
Default:	<code>MaxMemFree 0</code>
Context:	server config
Status:	MPM
Module:	BEOS , LEADER , MPM_NETWORK , PREFORK , THREADPOOL , WORKER , MPM_WINNT

The `MAXMEMFREE` directive sets the maximum number of free Kbytes that the main allocator is allowed to hold without calling `free()`. When not set, or when set to zero, the threshold will be set to unlimited.

MaxRequestsPerChild Directive

Description:	Limit on the number of requests that an individual child server will handle during its life
Syntax:	<code>MaxRequestsPerChild number</code>
Default:	<code>MaxRequestsPerChild 10000</code>
Context:	server config
Status:	MPM
Module:	LEADER , MPM_NETWORK , MPM_WINNT , MPMT_OS2 , PERCHILD , PREFORK , THREADPOOL , WORKER

The `MAXREQUESTSPERCHILD` directive sets the limit on the number of requests that an individual child server process will handle. After `MAXREQUESTSPERCHILD` requests, the child process will die. If `MAXREQUESTSPERCHILD` is 0, then the process will never expire.

⇒ Different default values

The default value for [MPM_NETWORK](#) and [MPM_WINNT](#) is 0.

Setting `MAXREQUESTSPERCHILD` to a non-zero limit has two beneficial effects:

- it limits the amount of memory that process can consume by (accidental) memory leakage;
- by giving processes a finite lifetime, it helps reduce the number of processes when the server load reduces.

⇒ Note

For [KEEPALIVE](#) requests, only the first request is counted towards this limit. In effect, it changes the behavior to limit the number of *connections* per child.

MaxSpareThreads Directive

Description:	Maximum number of idle threads
Syntax:	<code>MaxSpareThreads number</code>
Default:	See usage for details
Context:	server config
Status:	MPM
Module:	BEOS , LEADER , MPM_NETWORK , MPMT_OS2 , PERCHILD , THREADPOOL , WORKER

Maximum number of idle threads. Different MPMs deal with this directive differently.

For [PERCHILD](#) the default is `MaxSpareThreads 10`. This MPM monitors the number of idle threads on a per-child basis. If there are too many idle threads in that child, the server will begin to kill threads within that child.

For [WORKER](#), [LEADER](#) and [THREADPOOL](#) the default is `MaxSpareThreads 250`. These MPMs deal with idle threads on a server-wide basis. If there are too many idle threads in the server then child processes are killed until the number of idle threads is less than this number.

For `MPM_NETWARE` the default is `MaxSpareThreads 100`. Since this MPM runs a single-process, the spare thread count is also server-wide.

`BEOS` and `MPMT_OS2` work similar to `MPM_NETWARE`. The default for `BEOS` is `MaxSpareThreads 50`. For `MPMT_OS2` the default value is 10.

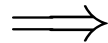

Restrictions

The range of the `MAXSPARETHREADS` value is restricted. Apache will correct the given value automatically according to the following rules:

- `PERCHILD` requires `MAXSPARETHREADS` to be less or equal than `THREADLIMIT`.
- `MPM_NETWARE` wants the value to be greater than `MINSPARETHREADS`.
- For `LEADER`, `THREADPOOL` and `WORKER` the value must be greater or equal than the sum of `MINSPARETHREADS` and `THREADSPERCHILD`.

See also

- `MINSPARETHREADS`
- `STARTSERVERS`

MinSpareThreads Directive

Description:	Minimum number of idle threads available to handle request spikes
Syntax:	<code>MinSpareThreads number</code>
Default:	See usage for details
Context:	server config
Status:	MPM
Module:	<code>BEOS</code> , <code>LEADER</code> , <code>MPM_NETWARE</code> , <code>MPMT_OS2</code> , <code>PERCHILD</code> , <code>THREADPOOL</code> , <code>WORKER</code>

Minimum number of idle threads to handle request spikes. Different MPMs deal with this directive differently.

`PERCHILD` uses a default of `MinSpareThreads 5` and monitors the number of idle threads on a per-child basis. If there aren't enough idle threads in that child, the server will begin to create new threads within that child. Thus, if you set `NUMSERVERS` to 10 and a `MINSPARETHREADS` value of 5, you'll have at least 50 idle threads on your system.

`WORKER`, `LEADER` and `THREADPOOL` use a default of `MinSpareThreads 75` and deal with idle threads on a server-wide basis. If there aren't enough idle threads in the server then child processes are created until the number of idle threads is greater than number.

`MPM_NETWARE` uses a default of `MinSpareThreads 10` and, since it is a single-process MPM, tracks this on a server-wide bases.

`BEOS` and `MPMT_OS2` work similar to `MPM_NETWARE`. The default for `BEOS` is `MinSpareThreads 1`. For `MPMT_OS2` the default value is 5.

See also

- `MAXSPARETHREADS`
- `STARTSERVERS`

PidFile Directive

Description:	File where the server records the process ID of the daemon
Syntax:	<code>PidFile filename</code>
Default:	<code>PidFile logs/httpd.pid</code>
Context:	server config
Status:	MPM
Module:	BEOS , LEADER , MPM_WINNT , MPMT_OS2 , PERCHILD , PREFORK , THREADPOOL , WORKER

The [PIDFILE](#) directive sets the file to which the server records the process id of the daemon. If the filename is not absolute then it is assumed to be relative to the [SERVERROOT](#).

Example

```
PidFile /var/run/apache.pid
```

It is often useful to be able to send the server a signal, so that it closes and then re-opens its [ERRORLOG](#) and [TRANSFERLOG](#), and re-reads its configuration files. This is done by sending a `SIGHUP` (kill -1) signal to the process id listed in the [PIDFILE](#).

The [PIDFILE](#) is subject to the same warnings about log file placement and security (p. 40) .

⇒ Note

As of Apache 2 it is recommended to use only the `apachectl` script for (re-)starting or stopping the server.

ReceiveBufferSize Directive

Description:	TCP receive buffer size
Syntax:	<code>ReceiveBufferSize bytes</code>
Default:	<code>ReceiveBufferSize 0</code>
Context:	server config
Status:	MPM
Module:	BEOS , LEADER , MPM_NETWARE , MPM_WINNT , MPMT_OS2 , PERCHILD , PREFORK , THREADPOOL , WORKER

The server will set the TCP receive buffer size to the number of bytes specified.

If set to the value of 0, the server will use the OS default.

ScoreBoardFile Directive

Description:	Location of the file used to store coordination data for the child processes
Syntax:	<code>ScoreBoardFile file-path</code>
Default:	<code>ScoreBoardFile logs/apache_status</code>
Context:	server config
Status:	MPM
Module:	BEOS , LEADER , MPM_WINNT , PERCHILD , PREFORK , THREADPOOL , WORKER

Apache uses a scoreboard to communicate between its parent and child processes. Some architectures require a file to facilitate this communication. If the file is left unspecified, Apache first attempts to create the scoreboard entirely in memory (using anonymous shared memory) and, failing that, will attempt to create the file on disk (using file-based shared memory). Specifying this directive causes Apache to always create the file on the disk.

Example

```
ScoreBoardFile /var/run/apache_status
```

File-based shared memory is useful for third-party applications that require direct access to the scoreboard.

If you use a [SCOREBOARDFILE](#) then you may see improved speed by placing it on a RAM disk. But be careful that you heed the same warnings about log file placement and security (p. 40).

See also

- [Stopping and Restarting Apache \(p. 16\)](#)

SendBufferSize Directive

Description:	TCP buffer size
Syntax:	SendBufferSize bytes
Default:	SendBufferSize 0
Context:	server config
Status:	MPM
Module:	BEOS , LEADER , MPM_NETWORK , MPM_WINNT , MPM_OS2 , PERCHILD , PREFORK , THREADPOOL , WORKER

The server will set the TCP send buffer size to the number of bytes specified. Very useful to increase past standard OS defaults on high speed high latency (*i.e.*, 100ms or so, such as transcontinental fast pipes).

If set to the value of 0, the server will use the OS default.

ServerLimit Directive

Description:	Upper limit on configurable number of processes
Syntax:	ServerLimit number
Default:	See usage for details
Context:	server config
Status:	MPM
Module:	LEADER , PERCHILD , PREFORK , THREADPOOL , WORKER

For the [PREFORK](#) MPM, this directive sets the maximum configured value for [MAXCLIENTS](#) for the lifetime of the Apache process. For the [WORKER](#) MPM, this directive in combination with [THREADLIMIT](#) sets the maximum configured value for [MAXCLIENTS](#) for the lifetime of the Apache process. Any attempts to change this directive during a restart will be ignored, but [MAXCLIENTS](#) can be modified during a restart.

Special care must be taken when using this directive. If [SERVERLIMIT](#) is set to a value much higher than necessary, extra, unused shared memory will be allocated. If both [SERVERLIMIT](#) and [MAXCLIENTS](#) are set to values higher than the system can handle, Apache may not start or the system may become unstable.

With the [PREFORK](#) MPM, use this directive only if you need to set [MAXCLIENTS](#) higher than 256 (default). Do not set the value of this directive any higher than what you might want to set [MAXCLIENTS](#) to.

With [WORKER](#), [LEADER](#) and [THREADPOOL](#) use this directive only if your [MAXCLIENTS](#) and [THREADSPERCHILD](#) settings require more than 16 server processes (default). Do not set the value of this directive any higher than the number of server processes required by what you may want for [MAXCLIENTS](#) and [THREADSPERCHILD](#).

With the [PERCHILD](#) MPM, use this directive only if you need to set [NUMSERVERS](#) higher than 8 (default).

→ Note

There is a hard limit of `ServerLimit 20000` compiled into the server. This is intended to avoid nasty effects caused by typos.

See also

- [Stopping and Restarting Apache \(p. 16\)](#)

StartServers Directive

Description:	Number of child server processes created at startup
Syntax:	StartServers number
Default:	See usage for details
Context:	server config
Status:	MPM
Module:	LEADER , MPMT_OS2 , PREFORK , THREADPOOL , WORKER

The [STARTSERVERS](#) directive sets the number of child server processes created on startup. As the number of processes is dynamically controlled depending on the load, there is usually little reason to adjust this parameter.

The default value differs from MPM to MPM. For [LEADER](#), [THREADPOOL](#) and [WORKER](#) the default is `StartServers 3`. For [PREFORK](#) defaults to 5 and for [MPMT_OS2](#) to 2.

StartThreads Directive

Description:	Number of threads created on startup
Syntax:	StartThreads number
Default:	See usage for details
Context:	server config
Status:	MPM
Module:	BEOS , MPM_NETWARE , PERCHILD

Number of threads created on startup. As the number of threads is dynamically controlled depending on the load, there is usually little reason to adjust this parameter.

For [PERCHILD](#) the default is `StartThreads 5` and this directive tracks the number of threads per process at startup.

For [MPM_NETWARE](#) the default is `StartThreads 50` and, since there is only a single process, this is the total number of threads created at startup to serve requests.

For [BEOS](#) the default is `StartThreads 10`. It also reflects the total number of threads created at startup to serve requests.

ThreadLimit Directive

Description:	Sets the upper limit on the configurable number of threads per child process
Syntax:	ThreadLimit number
Default:	See usage for details
Context:	server config
Status:	MPM
Module:	LEADER , MPM_WINNT , PERCHILD , THREADPOOL , WORKER
Compatibility:	Available for MPM_WINNT in Apache 2.0.41 and later

This directive sets the maximum configured value for [THREADSPERCHILD](#) for the lifetime of the Apache process. Any attempts to change this directive during a restart will be ignored, but [THREADSPERCHILD](#) can be modified during a restart up to the value of this directive.

Special care must be taken when using this directive. If [THREADLIMIT](#) is set to a value much higher than [THREADSPERCHILD](#), extra unused shared memory will be allocated. If both [THREADLIMIT](#) and [THREADSPERCHILD](#) are set to values higher than the system can handle, Apache may not start or the system may become unstable. Do not set the value of this directive any higher than your greatest predicted setting of [THREADSPERCHILD](#) for the current run of Apache.

The default value for [THREADLIMIT](#) is 1920 when used with [MPM_WINNT](#) and 64 when used with the others.

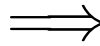
 **Note**

There is a hard limit of `ThreadLimit 20000` (or `ThreadLimit 15000` with `MPM_WINNT`) compiled into the server. This is intended to avoid nasty effects caused by typos.

ThreadsPerChild Directive

Description:	Number of threads created by each child process
Syntax:	<code>ThreadsPerChild number</code>
Default:	See usage for details
Context:	server config
Status:	MPM
Module:	LEADER , MPM_WINNT , THREADPOOL , WORKER

This directive sets the number of threads created by each child process. The child creates these threads at startup and never creates more. If using an MPM like [MPM_WINNT](#), where there is only one child process, this number should be high enough to handle the entire load of the server. If using an MPM like [WORKER](#), where there are multiple child processes, the *total* number of threads should be high enough to handle the common load on the server.

The default value for [THREADSPERCHILD](#) is 64 when used with [MPM_WINNT](#) and 25 when used with the others.

User Directive

Description:	The userid under which the server will answer requests
Syntax:	<code>User unix-userid</code>
Default:	<code>User #-1</code>
Context:	server config
Status:	MPM
Module:	LEADER , PERCHILD , PREFORK , THREADPOOL , WORKER
Compatibility:	Only valid in global server config since Apache 2.0

The [USER](#) directive sets the user ID as which the server will answer requests. In order to use this directive, the server must be run initially as `root`. If you start the server as a non-root user, it will fail to change to the lesser privileged user, and will instead continue to run as that original user. If you do start the server as `root`, then it is normal for the parent process to remain running as `root`. `unix-userid` is one of:

A `username` Refers to the given user by name.

followed by a user number. Refers to a user by its number.

The user should have no privileges that result in it being able to access files that are not intended to be visible to the outside world, and similarly, the user should not be able to execute code that is not meant for HTTP requests. It is recommended that you set up a new user and group specifically for running the server. Some admins use user `nobody`, but this is not always desirable, since the `nobody` user can have other uses on the system.



Security

Don't set [USER](#) (or [GROUP](#)) to `root` unless you know exactly what you are doing, and what the dangers are.

With the [PERCHILD](#) MPM, which is intended to server virtual hosts run under different user IDs, the [USER](#) directive defines the user ID for the main server and the fallback for `<VIRTUALHOST>` sections without an [ASSIGNUSERID](#) directive.

Special note: Use of this directive in `<VIRTUALHOST>` is no longer supported. To configure your server for `suexec` use [SUEXECUSERGROUP](#).

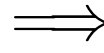
 **Note**

Although the `USER` directive is present in the `BEOS` and `MPMT_OS2` MPMs, it is actually a no-op there and only exists for compatibility reasons.

10.63 Apache Module leader

Description:	An experimental variant of the standard WORKER MPM
Status:	MPM
ModuleIdentifier:	mpm_leader_module
SourceFile:	leader.c

Summary



Warning

This MPM is experimental, so it may or may not work as expected.

This is an experimental variant of the standard [WORKER](#) MPM. It uses a Leader/Followers design pattern to coordinate work among threads. For more info, see <http://deuce.doc.wustl.edu/doc/pspdfs/lf.pdf>.

To use the [LEADER](#) MPM, add `--with-mpm=leader` to the configure script's arguments when building the httpd.

This MPM depends on APR's atomic compare-and-swap operations for thread synchronization. If you are compiling for an x86 target and you don't need to support 386s, or you are compiling for a SPARC and you don't need to run on pre-UltraSPARC chips, add `--enable-nonportable-atomics=yes` to the configure script's arguments. This will cause APR to implement atomic operations using efficient opcodes not available in older CPUs.

Directives

- [AcceptMutex](#) (p. 591)
- [CoreDumpDirectory](#) (p. 592)
- [EnableExceptionHook](#) (p. 593)
- [Group](#) (p. 593)
- [Listen](#) (p. 594)
- [ListenBacklog](#) (p. 594)
- [LockFile](#) (p. 595)
- [MaxClients](#) (p. 595)
- [MaxMemFree](#) (p. 596)
- [MaxRequestsPerChild](#) (p. 596)
- [MaxSpareThreads](#) (p. 596)
- [MinSpareThreads](#) (p. 597)
- [PidFile](#) (p. 598)
- [ReceiveBufferSize](#) (p. 598)
- [ScoreBoardFile](#) (p. 598)
- [SendBufferSize](#) (p. 599)
- [ServerLimit](#) (p. 599)
- [StartServers](#) (p. 600)
- [ThreadLimit](#) (p. 600)
- [ThreadsPerChild](#) (p. 601)
- [User](#) (p. 601)

10.64 Apache Module `mpm_netware`

Description:	Multi-Processing Module implementing an exclusively threaded web server optimized for Novell NetWare
Status:	MPM
ModuleIdentifier:	<code>mpm_netware_module</code>
SourceFile:	<code>mpm_netware.c</code>

Summary

This Multi-Processing Module (MPM) implements an exclusively threaded web server that has been optimized for Novell NetWare.

The main thread is responsible for launching child worker threads which listen for connections and serve them when they arrive. Apache always tries to maintain several spare or idle worker threads, which stand ready to serve incoming requests. In this way, clients do not need to wait for a new child threads to be spawned before their requests can be served.

The [STARTTHREADS](#), [MINSPARETHREADS](#), [MAXSPARETHREADS](#), and [MAXTHREADS](#) regulate how the main thread creates worker threads to serve requests. In general, Apache is very self-regulating, so most sites do not need to adjust these directives from their default values. Sites with limited memory may need to decrease [MAXTHREADS](#) to keep the server from thrashing (spawning and terminating idle threads). More information about tuning process creation is provided in the performance hints (p. 73) documentation.

[MAXREQUESTSPERCHILD](#) controls how frequently the server recycles processes by killing old ones and launching new ones. On the NetWare OS it is highly recommended that this directive remain set to 0. This allows worker threads to continue servicing requests indefinitely.

Directives

- [Listen](#) (p. 594)
- [ListenBacklog](#) (p. 594)
- [MaxMemFree](#) (p. 596)
- [MaxRequestsPerChild](#) (p. 596)
- [MaxSpareThreads](#) (p. 596)
- [MaxThreads](#)
- [MinSpareThreads](#) (p. 597)
- [ReceiveBufferSize](#) (p. 598)
- [SendBufferSize](#) (p. 599)
- [StartThreads](#) (p. 600)
- [ThreadStackSize](#)

See also

- [Setting which addresses and ports Apache uses](#) (p. 57)

MaxThreads Directive

Description:	Set the maximum number of worker threads
Syntax:	MaxThreads number
Default:	MaxThreads 2048
Context:	server config
Status:	MPM
Module:	mpm_network

The **MAXTHREADS** directive sets the desired maximum number worker threads allowable. The default value is also the compiled in hard limit. Therefore it can only be lowered, for example:

```
MaxThreads 512
```

ThreadStackSize Directive

Description:	Determine the stack size for each thread
Syntax:	ThreadStackSize number
Default:	ThreadStackSize 65536
Context:	server config
Status:	MPM
Module:	mpm_network

This directive tells the server what stack size to use for each of the running threads. If you ever get a stack overflow you will need to bump this number to a higher setting.

10.65 Apache Module `mpmt_os2`

Description:	Hybrid multi-process, multi-threaded MPM for OS/2
Status:	MPM
ModuleIdentifier:	<code>mpm_mpmt_os2_module</code>
SourceFile:	<code>mpmt_os2.c</code>

Summary

The Server consists of a main, parent process and a small, static number of child processes.

The parent process's job is to manage the child processes. This involves spawning children as required to ensure there are always `STARTSERVERS` processes accepting connections.

Each child process consists of a pool of worker threads and a main thread that accepts connections and passes them to the workers via a work queue. The worker thread pool is dynamic, managed by a maintenance thread so that the number of idle threads is kept between `MINSPARETHREADS` and `MAXSPARETHREADS`.

Directives

- `Group` (p. 593)
- `Listen` (p. 594)
- `ListenBacklog` (p. 594)
- `MaxRequestsPerChild` (p. 596)
- `MaxSpareThreads` (p. 596)
- `MinSpareThreads` (p. 597)
- `PidFile` (p. 598)
- `ReceiveBufferSize` (p. 598)
- `SendBufferSize` (p. 599)
- `StartServers` (p. 600)
- `User` (p. 601)

See also

- Setting which addresses and ports Apache uses (p. 57)

10.66 Apache Module perchild

Description:	Multi-Processing Module allowing for daemon processes serving requests to be assigned a variety of different userids
Status:	MPM
ModuleIdentifier:	mpm_perchild_module
SourceFile:	perchild.c

Summary



This module is not functional. Development of this module is not complete and is not currently active. Do not use [PERCHILD](#) unless you are a programmer willing to help fix it.

This Multi-Processing Module (MPM) implements a hybrid multi-process, multi-threaded web server. A fixed number of processes create threads to handle requests. Fluctuations in load are handled by increasing or decreasing the number of threads in each process.

Directives

- [AcceptMutex](#) (p. 591)
- [AssignUserID](#)
- [BS2000Account](#) (p. 592)
- [ChildPerUserID](#)
- [CoreDumpDirectory](#) (p. 592)
- [EnableExceptionHook](#) (p. 593)
- [Group](#) (p. 593)
- [Listen](#) (p. 594)
- [ListenBacklog](#) (p. 594)
- [LockFile](#) (p. 595)
- [MaxRequestsPerChild](#) (p. 596)
- [MaxSpareThreads](#) (p. 596)
- [MaxThreadsPerChild](#)
- [MinSpareThreads](#) (p. 597)
- [NumServers](#)
- [PidFile](#) (p. 598)
- [ReceiveBufferSize](#) (p. 598)
- [ScoreBoardFile](#) (p. 598)
- [SendBufferSize](#) (p. 599)
- [ServerLimit](#) (p. 599)
- [StartThreads](#) (p. 600)
- [ThreadLimit](#) (p. 600)
- [User](#) (p. 601)

See also

- [Setting which addresses and ports Apache uses](#) (p. 57)

How it works

A single control process launches the number of child processes indicated by the `NUMSERVERS` directive at server startup. Each child process creates threads as specified in the `STARTTHREADS` directive. The individual threads then listen for connections and serve them when they arrive.

Apache always tries to maintain a pool of spare or idle server threads, which stand ready to serve incoming requests. In this way, clients do not need to wait for new threads to be created. For each child process, Apache assesses the number of idle threads and creates or destroys threads to keep this number within the boundaries specified by `MINSPARETHREADS` and `MAXSPARETHREADS`. Since this process is very self-regulating, it is rarely necessary to modify these directives from their default values. The maximum number of clients that may be served simultaneously is determined by multiplying the number of server processes that will be created (`NUMSERVERS`) by the maximum number of threads created in each process (`MAXTHREADSPERCHILD`).

While the parent process is usually started as root under Unix in order to bind to port 80, the child processes and threads are launched by Apache as a less-privileged user. The `USER` and `GROUP` directives are used to set the privileges of the Apache child processes. The child processes must be able to read all the content that will be served, but should have as few privileges beyond that as possible. In addition, unless `suexec` is used, these directives also set the privileges which will be inherited by CGI scripts.

`MAXREQUESTSPERCHILD` controls how frequently the server recycles processes by killing old ones and launching new ones.

Working with different user-IDs

The `PERCHILD` MPM adds the extra ability to specify that particular processes should serve requests under different user-IDs. These user-IDs can then be associated with specific virtual hosts. You have to use one `CHILDPERUSERID` directive for every user/group combination you want to be run. Then you can tie particular virtual hosts to that user and group IDs.

The following example runs 7 child processes. Two of them are run under `user1/group1`. The next four are run under `user2/group2` and the remaining process uses the `USER` and `GROUP` of the main server:

```
Global config
NumServers 7
ChildPerUserID user1 group1 2
ChildPerUserID user2 group2 4
```

Using unbalanced numbers of processes as above is useful, if the particular virtual hosts produce different load. The assignment to the virtual hosts is easily done as in the example below. In conclusion with the example above the following assumes, that `server2` has to serve about twice of the hits of `server1`.

Example

```
NameVirtualHost *
<VirtualHost *>
    ServerName fallbackhost
    # no assignment; use fallback
</VirtualHost>
<VirtualHost *>
    ServerName server1
    AssignUserID user1 group1
</VirtualHost>
<VirtualHost *>
    ServerName server2
    AssignUserID user2 group2
</VirtualHost>
```

AssignUserID Directive

Description:	Tie a virtual host to a user and group ID
Syntax:	AssignUserID user-id group-id
Context:	virtual host
Status:	MPM
Module:	perchild

Tie a virtual host to a specific user/group combination. Requests addressed to the virtual host where this directive appears will be served by a process running with the specified user and group ID.

The user and group ID has to be assigned to a number of children in the global server config using the [CHILDPERUSERID](#) directive. See the section above for a configuration example.

ChildPerUserID Directive

Description:	Specify user ID and group ID for a number of child processes
Syntax:	ChildPerUserID user-id group-id num-children
Context:	server config
Status:	MPM
Module:	perchild

Specify a user ID and group ID for a number of child processes. The third argument, num-children, is the number of child processes to start with the specified user and group. It does *not* represent a specific child number. In order to use this directive, the server must be run initially as `root`. If you start the server as a non-root user, it will fail to change to the lesser privileged user.

If the total number of child processes, found by totaling all of the third arguments to all [CHILDPERUSERID](#) directives in the config file, is less than [NUMSERVERS](#), then all remaining children will inherit the [USER](#) and [GROUP](#) settings from the main server. See the section above for a configuration example.

**Security**

Don't set user-id (or group-id) to `root` unless you know exactly what you are doing, and what the dangers are.

MaxThreadsPerChild Directive

Description:	Maximum number of threads per child process
Syntax:	MaxThreadsPerChild number
Default:	MaxThreadsPerChild 64
Context:	server config
Status:	MPM
Module:	perchild

This directive sets the maximum number of threads that will be created in each child process. To increase this value beyond its default, it is necessary to change the value of the [THREADLIMIT](#) directive and stop and re-start the server.

NumServers Directive

Description:	Total number of children alive at the same time
Syntax:	NumServers number
Default:	NumServers 2
Context:	server config
Status:	MPM
Module:	perchild

The [NUMSERVERS](#) directive determines the number of children alive at the same time. This number should be large enough to handle the requests for the entire site. To increase this value beyond the value of 8, it is necessary to change the value of the [SERVERLIMIT](#) directive and stop and re-start the server. See the section above for a configuration example.

10.67 Apache Module prefork

Description:	Implements a non-threaded, pre-forking web server
Status:	MPM
ModuleIdentifier:	mpm_prefork_module
SourceFile:	prefork.c

Summary

This Multi-Processing Module (MPM) implements a non-threaded, pre-forking web server that handles requests in a manner similar to Apache 1.3. It is appropriate for sites that need to avoid threading for compatibility with non-thread-safe libraries. It is also the best MPM for isolating each request, so that a problem with a single request will not affect any other.

This MPM is very self-regulating, so it is rarely necessary to adjust its configuration directives. Most important is that `MAXCLIENTS` be big enough to handle as many simultaneous requests as you expect to receive, but small enough to assure that there is enough physical RAM for all processes.

Directives

- `AcceptMutex` (p. 591)
- `BS2000Account` (p. 592)
- `CoreDumpDirectory` (p. 592)
- `EnableExceptionHook` (p. 593)
- `Group` (p. 593)
- `Listen` (p. 594)
- `ListenBacklog` (p. 594)
- `LockFile` (p. 595)
- `MaxClients` (p. 595)
- `MaxMemFree` (p. 596)
- `MaxRequestsPerChild` (p. 596)
- `MaxSpareServers`
- `MinSpareServers`
- `PidFile` (p. 598)
- `ReceiveBufferSize` (p. 598)
- `ScoreBoardFile` (p. 598)
- `SendBufferSize` (p. 599)
- `ServerLimit` (p. 599)
- `StartServers` (p. 600)
- `User` (p. 601)

See also

- Setting which addresses and ports Apache uses (p. 57)

How it Works

A single control process is responsible for launching child processes which listen for connections and serve them when they arrive. Apache always tries to maintain several spare or idle server processes, which stand ready to serve incoming requests. In this way, clients do not need to wait for a new child processes to be forked before their requests can be served.

The [STARTSERVERS](#), [MINSPARESERVERS](#), [MAXSPARESERVERS](#), and [MAXCLIENTS](#) regulate how the parent process creates children to serve requests. In general, Apache is very self-regulating, so most sites do not need to adjust these directives from their default values. Sites which need to serve more than 256 simultaneous requests may need to increase [MAXCLIENTS](#), while sites with limited memory may need to decrease [MAXCLIENTS](#) to keep the server from thrashing (swapping memory to disk and back). More information about tuning process creation is provided in the performance hints (p. 73) documentation.

While the parent process is usually started as `root` under Unix in order to bind to port 80, the child processes are launched by Apache as a less-privileged user. The [USER](#) and [GROUP](#) directives are used to set the privileges of the Apache child processes. The child processes must be able to read all the content that will be served, but should have as few privileges beyond that as possible.

[MAXREQUESTSPERCHILD](#) controls how frequently the server recycles processes by killing old ones and launching new ones.

MaxSpareServers Directive

Description:	Maximum number of idle child server processes
Syntax:	<code>MaxSpareServers number</code>
Default:	<code>MaxSpareServers 10</code>
Context:	server config
Status:	MPM
Module:	prefork

The [MAXSPARESERVERS](#) directive sets the desired maximum number of *idle* child server processes. An idle process is one which is not handling a request. If there are more than [MAXSPARESERVERS](#) idle, then the parent process will kill off the excess processes.

Tuning of this parameter should only be necessary on very busy sites. Setting this parameter to a large number is almost always a bad idea. If you are trying to set the value lower than [MINSPARESERVERS](#), Apache will automatically adjust it to [MINSPARESERVERS](#) + 1.

See also

- [MINSPARESERVERS](#)
- [STARTSERVERS](#)

MinSpareServers Directive

Description:	Minimum number of idle child server processes
Syntax:	<code>MinSpareServers number</code>
Default:	<code>MinSpareServers 5</code>
Context:	server config
Status:	MPM
Module:	prefork

The [MINSPARESERVERS](#) directive sets the desired minimum number of *idle* child server processes. An idle process is one which is not handling a request. If there are fewer than [MINSPARESERVERS](#) idle, then the parent process creates new children at a maximum rate of 1 per second.

Tuning of this parameter should only be necessary on very busy sites. Setting this parameter to a large number is almost always a bad idea.

See also

- [MAXSPARESERVERS](#)
- [STARTSERVERS](#)

10.68 Apache Module threadpool

Description:	Yet another experimental variant of the standard WORKER MPM
Status:	MPM
ModuleIdentifier:	mpm_threadpool_module
SourceFile:	threadpool.c

Summary



Warning

This MPM is a developer playground and highly experimental, so it may or may not work as expected.

This is an experimental variant of the standard worker MPM. Rather than queuing connections like the worker MPM, the [THREADPOOL](#) MPM queues idle worker threads and hands each accepted connection to the next available worker.

The [THREADPOOL](#) MPM can't match the performance of the [WORKER](#) MPM in benchmark testing. As of 2.0.39, some of the key load-throttling concepts from the [THREADPOOL](#) MPM have been incorporated into the [WORKER](#) MPM. The [THREADPOOL](#) code is useful primarily as a research platform. For general-purpose use and for any production environments, use [WORKER](#) instead.

Directives

- [AcceptMutex](#) (p. 591)
- [CoreDumpDirectory](#) (p. 592)
- [EnableExceptionHook](#) (p. 593)
- [Group](#) (p. 593)
- [Listen](#) (p. 594)
- [ListenBacklog](#) (p. 594)
- [LockFile](#) (p. 595)
- [MaxClients](#) (p. 595)
- [MaxMemFree](#) (p. 596)
- [MaxRequestsPerChild](#) (p. 596)
- [MaxSpareThreads](#) (p. 596)
- [MinSpareThreads](#) (p. 597)
- [PidFile](#) (p. 598)
- [ReceiveBufferSize](#) (p. 598)
- [ScoreBoardFile](#) (p. 598)
- [SendBufferSize](#) (p. 599)
- [ServerLimit](#) (p. 599)
- [StartServers](#) (p. 600)
- [ThreadLimit](#) (p. 600)
- [ThreadsPerChild](#) (p. 601)
- [User](#) (p. 601)

10.69 Apache Module `mpm_winnt`

Description:	This Multi-Processing Module is optimized for Windows NT.
Status:	MPM
ModuleIdentifier:	<code>mpm_winnt_module</code>
SourceFile:	<code>mpm_winnt.c</code>

Summary

This Multi-Processing Module (MPM) is the default for the Windows NT operating systems. It uses a single control process which launches a single child process which in turn creates threads to handle requests

Directives

- `CoreDumpDirectory` (p. 592)
- `Listen` (p. 594)
- `ListenBacklog` (p. 594)
- `MaxMemFree` (p. 596)
- `MaxRequestsPerChild` (p. 596)
- `PidFile` (p. 598)
- `ReceiveBufferSize` (p. 598)
- `ScoreBoardFile` (p. 598)
- `SendBufferSize` (p. 599)
- `ThreadLimit` (p. 600)
- `ThreadsPerChild` (p. 601)
- `Win32DisableAcceptEx`

Win32DisableAcceptEx Directive

Description:	Use <code>accept()</code> rather than <code>AcceptEx()</code> to accept network connections
Syntax:	<code>Win32DisableAcceptEx</code>
Default:	<code>AcceptEx()</code> is enabled by default. Use this directive to disable use of <code>AcceptEx()</code>
Context:	server config
Status:	MPM
Module:	<code>mpm_winnt</code>
Compatibility:	Available in Version 2.0.49 and later

`AcceptEx()` is a Microsoft WinSock v2 API that provides some performance improvements over the use of the BSD style `accept()` API in certain circumstances. Some popular Windows products, typically virus scanning or virtual private network packages, have bugs that interfere with the proper operation of `AcceptEx()`. If you encounter an error condition like:

```
[error] (730038)An operation was attempted on something that is not a
socket.: winnt_accept: AcceptEx failed. Attempting to recover.
```

you should use this directive to disable the use of `AcceptEx()`.

10.70 Apache Module worker

Description:	Multi-Processing Module implementing a hybrid multi-threaded multi-process web server
Status:	MPM
ModuleIdentifier:	mpm_worker_module
SourceFile:	worker.c

Summary

This Multi-Processing Module (MPM) implements a hybrid multi-process multi-threaded server. By using threads to serve requests, it is able to serve a large number of requests with less system resources than a process-based server. Yet it retains much of the stability of a process-based server by keeping multiple processes available, each with many threads.

The most important directives used to control this MPM are [THREADSPERCHILD](#), which controls the number of threads deployed by each child process and [MAXCLIENTS](#), which controls the maximum total number of threads that may be launched.

Directives

- [AcceptMutex](#) (p. 591)
- [CoreDumpDirectory](#) (p. 592)
- [EnableExceptionHook](#) (p. 593)
- [Group](#) (p. 593)
- [Listen](#) (p. 594)
- [ListenBacklog](#) (p. 594)
- [LockFile](#) (p. 595)
- [MaxClients](#) (p. 595)
- [MaxMemFree](#) (p. 596)
- [MaxRequestsPerChild](#) (p. 596)
- [MaxSpareThreads](#) (p. 596)
- [MinSpareThreads](#) (p. 597)
- [PidFile](#) (p. 598)
- [ReceiveBufferSize](#) (p. 598)
- [ScoreBoardFile](#) (p. 598)
- [SendBufferSize](#) (p. 599)
- [ServerLimit](#) (p. 599)
- [StartServers](#) (p. 600)
- [ThreadLimit](#) (p. 600)
- [ThreadsPerChild](#) (p. 601)
- [User](#) (p. 601)

See also

- [Setting which addresses and ports Apache uses](#) (p. 57)

How it Works

A single control process (the parent) is responsible for launching child processes. Each child process creates a fixed number of server threads as specified in the `THREADSPERCHILD` directive, as well as a listener thread which listens for connections and passes them to a server thread for processing when they arrive.

Apache always tries to maintain a pool of spare or idle server threads, which stand ready to serve incoming requests. In this way, clients do not need to wait for a new threads or processes to be created before their requests can be served. The number of processes that will initially launched is set by the `STARTSERVERS` directive. Then during operation, Apache assesses the total number of idle threads in all processes, and forks or kills processes to keep this number within the boundaries specified by `MINSPARETHREADS` and `MAXSPARETHREADS`. Since this process is very self-regulating, it is rarely necessary to modify these directives from their default values. The maximum number of clients that may be served simultaneously (i.e., the maximum total number of threads in all processes) is determined by the `MAXCLIENTS` directive. The maximum number of active child processes is determined by the `MAXCLIENTS` directive divided by the `THREADSPERCHILD` directive.

Two directives set hard limits on the number of active child processes and the number of server threads in a child process, and can only be changed by fully stopping the server and then starting it again. `SERVERLIMIT` is a hard limit on the number of active child processes, and must be greater than or equal to the `MAXCLIENTS` directive divided by the `THREADSPERCHILD` directive. `THREADLIMIT` is a hard limit of the number of server threads, and must be greater than or equal to the `THREADSPERCHILD` directive. If non-default values are specified for these directives, they should appear before other `WORKER` directives.

In addition to the set of active child processes, there may be additional child processes which are terminating but where at least one server thread is still handling an existing client connection. Up to `MAXCLIENTS` terminating processes may be present, though the actual number can be expected to be much smaller. This behavior can be avoided by disabling the termination of individual child processes, which is achieved by the following:

- set the value of `MAXREQUESTSPERCHILD` to zero
- set the value of `MAXSPARETHREADS` to the same value as `MAXCLIENTS`

A typical configuration of the process-thread controls in the `WORKER` MPM could look as follows:

```
ServerLimit 16
StartServers 2
MaxClients 150
MinSpareThreads 25
MaxSpareThreads 75
ThreadsPerChild 25
```

While the parent process is usually started as `root` under Unix in order to bind to port 80, the child processes and threads are launched by Apache as a less-privileged user. The `USER` and `GROUP` directives are used to set the privileges of the Apache child processes. The child processes must be able to read all the content that will be served, but should have as few privileges beyond that as possible. In addition, unless `suexec` is used, these directives also set the privileges which will be inherited by CGI scripts.

`MAXREQUESTSPERCHILD` controls how frequently the server recycles processes by killing old ones and launching new ones.

Chapter 11

Developer Documentation

11.1 Developer Documentation for Apache 2.0

Many of the documents on these Developer pages are lifted from Apache 1.3's documentation. While they are all being updated to Apache 2.0, they are in different stages of progress. Please be patient, and point out any discrepancies or errors on the developer/ pages directly to the dev@httpd.apache.org¹ mailing list.

Topics

- [Apache 1.3 API Notes](#) (p. 621)
- [Apache 2.0 Hook Functions](#) (p. 641)
- [Request Processing in Apache 2.0](#) (p. 648)
- [How filters work in Apache 2.0](#) (p. 652)
- [Converting Modules from Apache 1.3 to Apache 2.0](#) (p. 644)
- [Debugging Memory Allocation in APR](#) (p. 637)
- [Documenting Apache 2.0](#) (p. 640)
- [Apache 2.0 Thread Safety Issues](#) (p. ??)

External Resources

- Tools provided by Ian Holsman:
 - [Apache 2 cross reference](#)²
 - [Autogenerated Apache 2 code documentation](#)³
- Module Development Tutorials by Kevin O'Donnell
 - [Integrating a module into the Apache build system](#)⁴
 - [Handling configuration directives](#)⁵
- [Some notes on Apache module development by Ryan Bloom](#)⁶

¹<http://httpd.apache.org/lists.html#http-dev>

²<http://lxr.webperf.org/>

³<http://docx.webperf.org/>

⁴http://threebit.net/tutorials/apache2_modules/tut1/tutorial1.html

⁵http://threebit.net/tutorials/apache2_modules/tut2/tutorial2.html

⁶<http://www.onlamp.com/pub/ct/38>

11.2 Apache 1.3 API notes



Warning

This document has not been updated to take into account changes made in the 2.0 version of the Apache HTTP Server. Some of the information may still be relevant, but please use it with care.

These are some notes on the Apache API and the data structures you have to deal with, *etc.* They are not yet nearly complete, but hopefully, they will help you get your bearings. Keep in mind that the API is still subject to change as we gain experience with it. (See the TODO file for what *might* be coming). However, it will be easy to adapt modules to any changes that are made. (We have more modules to adapt than you do).

A few notes on general pedagogical style here. In the interest of conciseness, all structure declarations here are incomplete – the real ones have more slots that I'm not telling you about. For the most part, these are reserved to one component of the server core or another, and should be altered by modules with caution. However, in some cases, they really are things I just haven't gotten around to yet. Welcome to the bleeding edge.

Finally, here's an outline, to give you some bare idea of what's coming up, and in what order:

- Basic concepts.
 - Handlers, Modules, and Requests
 - A brief tour of a module
- How handlers work
 - A brief tour of the `request_rec`
 - Where `request_rec` structures come from
 - Handling requests, declining, and returning error codes
 - Special considerations for response handlers
 - Special considerations for authentication handlers
 - Special considerations for logging handlers
- Resource allocation and resource pools
- Configuration, commands and the like
 - Per-directory configuration structures
 - Command handling
 - Side notes — per-server configuration, virtual servers, *etc.*

Basic concepts

We begin with an overview of the basic concepts behind the API, and how they are manifested in the code.

Handlers, Modules, and Requests

Apache breaks down request handling into a series of steps, more or less the same way the Netscape server API does (although this API has a few more stages than NetSite does, as hooks for stuff I thought might be useful in the future). These are:

- URI -> Filename translation

- Auth ID checking [is the user who they say they are?]
- Auth access checking [is the user authorized *here*?]
- Access checking other than auth
- Determining MIME type of the object requested
- ‘Fixups’ – there aren’t any of these yet, but the phase is intended as a hook for possible extensions like `SETENV`, which don’t really fit well elsewhere.
- Actually sending a response back to the client.
- Logging the request

These phases are handled by looking at each of a succession of *modules*, looking to see if each of them has a handler for the phase, and attempting invoking it if so. The handler can typically do one of three things:

- *Handle* the request, and indicate that it has done so by returning the magic constant `OK`.
- *Decline* to handle the request, by returning the magic integer constant `DECLINED`. In this case, the server behaves in all respects as if the handler simply hadn’t been there.
- Signal an error, by returning one of the HTTP error codes. This terminates normal handling of the request, although an `ErrorDocument` may be invoked to try to mop up, and it will be logged in any case.

Most phases are terminated by the first module that handles them; however, for logging, ‘fixups’, and non-access authentication checking, all handlers always run (barring an error). Also, the response phase is unique in that modules may declare multiple handlers for it, via a dispatch table keyed on the MIME type of the requested object. Modules may declare a response-phase handler which can handle *any* request, by giving it the key `*/*` (*i.e.*, a wildcard MIME type specification). However, wildcard handlers are only invoked if the server has already tried and failed to find a more specific response handler for the MIME type of the requested object (either none existed, or they all declined).

The handlers themselves are functions of one argument (a `request_rec` structure. *vide infra*), which returns an integer, as above.

A brief tour of a module

At this point, we need to explain the structure of a module. Our candidate will be one of the messier ones, the CGI module – this handles both CGI scripts and the `SCRIPTALIAS` config file command. It’s actually a great deal more complicated than most modules, but if we’re going to have only one example, it might as well be the one with its fingers in every place.

Let’s begin with handlers. In order to handle the CGI scripts, the module declares a response handler for them. Because of `SCRIPTALIAS`, it also has handlers for the name translation phase (to recognize `SCRIPTALIASED` URIs), the type-checking phase (any `SCRIPTALIASED` request is typed as a CGI script).

The module needs to maintain some per (virtual) server information, namely, the `SCRIPTALIASES` in effect; the module structure therefore contains pointers to a functions which builds these structures, and to another which combines two of them (in case the main server and a virtual server both have `SCRIPTALIASES` declared).

Finally, this module contains code to handle the `SCRIPTALIAS` command itself. This particular module only declares one command, but there could be more, so modules have *command tables* which declare their commands, and describe where they are permitted, and how they are to be invoked.

A final note on the declared types of the arguments of some of these commands: a `pool` is a pointer to a *resource pool* structure; these are used by the server to keep track of the memory which has been allocated, files opened, *etc.*, either to service a particular request, or to handle the process of configuring itself. That way, when the request is over (or, for the configuration pool, when the server is restarting), the memory can be freed, and the files closed, *en masse*, without anyone having to write explicit code to track them all down and dispose of them. Also, a `cmd_parms` structure

contains various information about the config file being read, and other status information, which is sometimes of use to the function which processes a config-file command (such as [SCRIPTALIAS](#)). With no further ado, the module itself:

```

/* Declarations of handlers. */
int translate_scriptalias (request_rec *);
int type_scriptalias (request_rec *);
int cgi_handler (request_rec *);
/* Subsidiary dispatch table for response-phase
 * handlers, by MIME type */
handler_rec cgi_handlers[] = {
    { "application/x-httpd-cgi", cgi_handler },
    { NULL }
};
/* Declarations of routines to manipulate the
 * module's configuration info. Note that these are
 * returned, and passed in, as void *'s; the server
 * core keeps track of them, but it doesn't, and can't,
 * know their internal structure.
 */
void *make_cgi_server_config (pool *);
void *merge_cgi_server_config (pool *, void *, void *);
/* Declarations of routines to handle config-file commands */
extern char *script_alias(cmd_parms *, void *per_dir_config, char
*fake, char *real);
command_rec cgi_cmds[] = {
    { "ScriptAlias", script_alias, NULL, RSRC_CONF, TAKE2,
      "a fakename and a realname"},
    { NULL }
};
module cgi_module = {
    STANDARD_MODULE_STUFF,
    NULL, /* initializer */
    NULL, /* dir config creator */
    NULL, /* dir merger */
    make_cgi_server_config, /* server config */
    merge_cgi_server_config, /* merge server config */
    cgi_cmds, /* command table */
    cgi_handlers, /* handlers */
    translate_scriptalias, /* filename translation */
    NULL, /* check_user_id */
    NULL, /* check_auth */
    NULL, /* check_access */
    type_scriptalias, /* type_checker */
    NULL, /* fixups */
    NULL, /* logger */
    NULL /* header parser */
};

```

How handlers work

The sole argument to handlers is a `request_rec` structure. This structure describes a particular request which has been made to the server, on behalf of a client. In most cases, each connection to the client generates only one `request_rec` structure.

A brief tour of the `request_rec`

The `request_rec` contains pointers to a resource pool which will be cleared when the server is finished handling the request; to structures containing per-server and per-connection information, and most importantly, information on the request itself.

The most important such information is a small set of character strings describing attributes of the object being requested, including its URI, filename, content-type and content-encoding (these being filled in by the translation and type-check handlers which handle the request, respectively).

Other commonly used data items are tables giving the MIME headers on the client's original request, MIME headers to be sent back with the response (which modules can add to at will), and environment variables for any subprocesses which are spawned off in the course of servicing the request. These tables are manipulated using the `ap_table_get` and `ap_table_set` routines.

⇒ Note that the `Content-type` header value *cannot* be set by module content-handlers using the `ap_table_*()` routines. Rather, it is set by pointing the `content_type` field in the `request_rec` structure to an appropriate string. *e.g.*,

```
r->content_type = "text/html";
```

Finally, there are pointers to two data structures which, in turn, point to per-module configuration structures. Specifically, these hold pointers to the data structures which the module has built to describe the way it has been configured to operate in a given directory (via `.htaccess` files or `<DIRECTORY>` sections), for private data it has built in the course of servicing the request (so modules' handlers for one phase can pass 'notes' to their handlers for other phases). There is another such configuration vector in the `server_rec` data structure pointed to by the `request_rec`, which contains per (virtual) server configuration data.

Here is an abridged declaration, giving the fields most commonly used:

```

struct request_rec {
pool *pool;
conn_rec *connection;
server_rec *server;
/* What object is being requested */
char *uri;
char *filename;
char *path_info;

char *args;          /* QUERY_ARGS, if any */
struct stat finfo;   /* Set by server core;
                    * st_mode set to zero if no such file */

char *content_type;
char *content_encoding;
/* MIME header environments, in and out. Also,
 * an array containing environment variables to
 * be passed to subprocesses, so people can write
 * modules to add to that environment.
 *
 * The difference between headers_out and
 * err_headers_out is that the latter are printed
 * even on error, and persist across internal
 * redirects (so the headers printed for
 * ERRORDOCUMENT handlers will have them).
 */
table *headers_in;
table *headers_out;
table *err_headers_out;
table *subprocess_env;
/* Info about the request itself... */

int header_only;    /* HEAD request, as opposed to GET */
char *protocol;     /* Protocol, as given to us, or HTTP/0.9 */
char *method;       /* GET, HEAD, POST, etc. */
int method_number;  /* M_GET, M_POST, etc. */

/* Info for logging */
char *the_request;
int bytes_sent;
/* A flag which modules can set, to indicate that
 * the data being returned is volatile, and clients
 * should be told not to cache it.
 */
int no_cache;
/* Various other config info which may change
 * with .htaccess files
 * These are config vectors, with one void*
 * pointer for each module (the thing pointed
 * to being the module's business).
 */

void *per_dir_config; /* Options set in config files, etc. */
void *request_config; /* Notes on *this* request */

};

```

Where `request_rec` structures come from

Most `request_rec` structures are built by reading an HTTP request from a client, and filling in the fields. However, there are a few exceptions:

- If the request is to an imagemap, a type map (*i.e.*, a `*.var` file), or a CGI script which returned a local ‘Location:’, then the resource which the user requested is going to be ultimately located by some URI other than what the client originally supplied. In this case, the server does an *internal redirect*, constructing a new `request_rec` for the new URI, and processing it almost exactly as if the client had requested the new URI directly.
- If some handler signaled an error, and an `ErrorDocument` is in scope, the same internal redirect machinery comes into play.
- Finally, a handler occasionally needs to investigate ‘what would happen if’ some other request were run. For instance, the directory indexing module needs to know what MIME type would be assigned to a request for each directory entry, in order to figure out what icon to use.

Such handlers can construct a *sub-request*, using the functions `ap_sub_req_lookup_file`, `ap_sub_req_lookup_uri`, and `ap_sub_req_method_uri`; these construct a new `request_rec` structure and processes it as you would expect, up to but not including the point of actually sending a response. (These functions skip over the access checks if the sub-request is for a file in the same directory as the original request).

(Server-side includes work by building sub-requests and then actually invoking the response handler for them, via the function `ap_run_sub_req`).

Handling requests, declining, and returning error codes

As discussed above, each handler, when invoked to handle a particular `request_rec`, has to return an `int` to indicate what happened. That can either be

- `OK` – the request was handled successfully. This may or may not terminate the phase.
- `DECLINED` – no erroneous condition exists, but the module declines to handle the phase; the server tries to find another.
- an HTTP error code, which aborts handling of the request.

Note that if the error code returned is `REDIRECT`, then the module should put a `Location` in the request’s `headers_out`, to indicate where the client should be redirected *to*.

Special considerations for response handlers

Handlers for most phases do their work by simply setting a few fields in the `request_rec` structure (or, in the case of access checkers, simply by returning the correct error code). However, response handlers have to actually send a request back to the client.

They should begin by sending an HTTP response header, using the function `ap_send_http_header`. (You don’t have to do anything special to skip sending the header for HTTP/0.9 requests; the function figures out on its own that it shouldn’t do anything). If the request is marked `header_only`, that’s all they should do; they should return after that, without attempting any further output.

Otherwise, they should produce a request body which responds to the client as appropriate. The primitives for this are `ap_rputc` and `ap_rprintf`, for internally generated output, and `ap_send_fd`, to copy the contents of some `FILE` * straight to the client.

At this point, you should more or less understand the following piece of code, which is the handler which handles GET requests which have no more specific handler; it also shows how conditional GETs can be handled, if it's desirable to do so in a particular response handler – `ap_set_last_modified` checks against the `If-modified-since` value supplied by the client, if any, and returns an appropriate code (which will, if nonzero, be `USE_LOCAL_COPY`). No similar considerations apply for `ap_set_content_length`, but it returns an error code for symmetry.

```
int default_handler (request_rec *r)
{
    int errstatus;
    FILE *f;
    if (r->method_number != M_GET) return DECLINED;
    if (r->finfo.st_mode == 0) return NOT_FOUND;
    if ((errstatus = ap_set_content_length (r, r->finfo.st_size))
        || (errstatus = ap_set_last_modified (r, r->finfo.st_mtime))
        return errstatus;
    f = fopen (r->filename, "r");
    if (f == NULL) {
        log_reason("file permissions deny server access", r->filename,
            r);
        return FORBIDDEN;
    }
    register_timeout ("send", r);
    ap_send_http_header (r);
    if (!r->header_only) send_fd (f, r);
    ap_pfclose (r->pool, f);
    return OK;
}
```

Finally, if all of this is too much of a challenge, there are a few ways out of it. First off, as shown above, a response handler which has not yet produced any output can simply return an error code, in which case the server will automatically produce an error response. Secondly, it can punt to some other handler by invoking `ap_internal_redirect`, which is how the internal redirection machinery discussed above is invoked. A response handler which has internally redirected should always return `OK`.

(Invoking `ap_internal_redirect` from handlers which are *not* response handlers will lead to serious confusion).

Special considerations for authentication handlers

Stuff that should be discussed here in detail:

- Authentication-phase handlers not invoked unless `auth` is configured for the directory.
- Common `auth` configuration stored in the core per-dir configuration; it has accessors `ap_auth_type`, `ap_auth_name`, and `ap_requires`.
- Common routines, to handle the protocol end of things, at least for HTTP basic authentication (`ap_get_basic_auth_pw`, which sets the `connection->user` structure field automatically, and `ap_note_basic_auth_failure`, which arranges for the proper `WWW-Authenticate:` header to be sent back).

Special considerations for logging handlers

When a request has internally redirected, there is the question of what to log. Apache handles this by bundling the entire chain of redirects into a list of `request_rec` structures which are threaded through the `r->prev` and `r->next` pointers. The `request_rec` which is passed to the logging handlers in such cases is the one which was originally built for the initial request from the client; note that the `bytes_sent` field will only be correct in the last request in the chain (the one for which a response was actually sent).

Resource allocation and resource pools

One of the problems of writing and designing a server-pool server is that of preventing leakage, that is, allocating resources (memory, open files, *etc.*), without subsequently releasing them. The resource pool machinery is designed to make it easy to prevent this from happening, by allowing resource to be allocated in such a way that they are *automatically* released when the server is done with them.

The way this works is as follows: the memory which is allocated, file opened, *etc.*, to deal with a particular request are tied to a *resource pool* which is allocated for the request. The pool is a data structure which itself tracks the resources in question.

When the request has been processed, the pool is *cleared*. At that point, all the memory associated with it is released for reuse, all files associated with it are closed, and any other clean-up functions which are associated with the pool are run. When this is over, we can be confident that all the resource tied to the pool have been released, and that none of them have leaked.

Server restarts, and allocation of memory and resources for per-server configuration, are handled in a similar way. There is a *configuration pool*, which keeps track of resources which were allocated while reading the server configuration files, and handling the commands therein (for instance, the memory that was allocated for per-server module configuration, log files and other files that were opened, and so forth). When the server restarts, and has to reread the configuration files, the configuration pool is cleared, and so the memory and file descriptors which were taken up by reading them the last time are made available for reuse.

It should be noted that use of the pool machinery isn't generally obligatory, except for situations like logging handlers, where you really need to register cleanups to make sure that the log file gets closed when the server restarts (this is most easily done by using the function `ap_pfdopen`, which also arranges for the underlying file descriptor to be closed before any child processes, such as for CGI scripts, are `execed`), or in case you are using the timeout machinery (which isn't yet even documented here). However, there are two benefits to using it: resources allocated to a pool never leak (even if you allocate a scratch string, and just forget about it); also, for memory allocation, `ap_palloc` is generally faster than `malloc`.

We begin here by describing how memory is allocated to pools, and then discuss how other resources are tracked by the resource pool machinery.

Allocation of memory in pools

Memory is allocated to pools by calling the function `ap_palloc`, which takes two arguments, one being a pointer to a resource pool structure, and the other being the amount of memory to allocate (in `chars`). Within handlers for handling requests, the most common way of getting a resource pool structure is by looking at the `pool` slot of the relevant `request_rec`; hence the repeated appearance of the following idiom in module code:

```

int my_handler(request_rec *r)
{
    struct my_structure *foo;
    ...
    foo = (foo *)ap_palloc (r->pool, sizeof(my_structure));
}

```

Note that *there is no* `ap_pfree` – `ap_palloc`d memory is freed only when the associated resource pool is cleared. This means that `ap_palloc` does not have to do as much accounting as `malloc()`; all it does in the typical case is to round up the size, bump a pointer, and do a range check.

(It also raises the possibility that heavy use of `ap_palloc` could cause a server process to grow excessively large. There are two ways to deal with this, which are dealt with below; briefly, you can use `malloc`, and try to be sure that all of the memory gets explicitly freed, or you can allocate a sub-pool of the main pool, allocate your memory in the sub-pool, and clear it out periodically. The latter technique is discussed in the section on sub-pools below, and is used in the directory-indexing code, in order to avoid excessive storage allocation when listing directories with thousands of files).

Allocating initialized memory

There are functions which allocate initialized memory, and are frequently useful. The function `ap_pccalloc` has the same interface as `ap_palloc`, but clears out the memory it allocates before it returns it. The function `ap_pstrdup` takes a resource pool and a `char *` as arguments, and allocates memory for a copy of the string the pointer points to, returning a pointer to the copy. Finally `ap_pstrcat` is a varargs-style function, which takes a pointer to a resource pool, and at least two `char *` arguments, the last of which must be `NULL`. It allocates enough memory to fit copies of each of the strings, as a unit; for instance:

```
ap_pstrcat (r->pool, "foo", "/", "bar", NULL);
```

returns a pointer to 8 bytes worth of memory, initialized to "foo/bar".

Commonly-used pools in the Apache Web server

A pool is really defined by its lifetime more than anything else. There are some static pools in `http_main` which are passed to various non-`http_main` functions as arguments at opportune times. Here they are:

permanent_pool never passed to anything else, this is the ancestor of all pools

pconf • subpool of `permanent_pool`

- created at the beginning of a config "cycle"; exists until the server is terminated or restarts; passed to all config-time routines, either via `cmd->pool`, or as the "pool *p" argument on those which don't take pools
- passed to the module `init()` functions

ptemp • sorry I lie, this pool isn't called this currently in 1.3, I renamed it this in my pthreads development. I'm referring to the use of `ptrans` in the parent... contrast this with the later definition of `ptrans` in the child.

- subpool of `permanent_pool`
- created at the beginning of a config "cycle"; exists until the end of config parsing; passed to config-time routines *via* `cmd->temp_pool`. Somewhat of a "bastard child" because it isn't available everywhere. Used for temporary scratch space which may be needed by some config routines but which is deleted at the end of config.

- pchild**
- subpool of permanent_pool
 - created when a child is spawned (or a thread is created); lives until that child (thread) is destroyed
 - passed to the module child_init functions
 - destruction happens right after the child_exit functions are called... (which may explain why I think child_exit is redundant and unneeded)
- ptrans**
- should be a subpool of pchild, but currently is a subpool of permanent_pool, see above
 - cleared by the child before going into the accept() loop to receive a connection
 - used as connection->pool
- r->pool**
- for the main request this is a subpool of connection->pool; for subrequests it is a subpool of the parent request's pool.
 - exists until the end of the request (*i.e.*, ap_destroy_sub_req, or in child_main after process_request has finished)
 - note that r itself is allocated from r->pool; *i.e.*, r->pool is first created and then r is the first thing palloc(d from it

For almost everything folks do, r->pool is the pool to use. But you can see how other lifetimes, such as pchild, are useful to some modules... such as modules that need to open a database connection once per child, and wish to clean it up when the child dies.

You can also see how some bugs have manifested themselves, such as setting connection->user to a value from r->pool – in this case connection exists for the lifetime of ptrans, which is longer than r->pool (especially if r->pool is a subrequest!). So the correct thing to do is to allocate from connection->pool.

And there was another interesting bug in [MOD_INCLUDE](#) / [MOD_CGI](#). You'll see in those that they do this test to decide if they should use r->pool or r->main->pool. In this case the resource that they are registering for cleanup is a child process. If it were registered in r->pool, then the code would wait() for the child when the subrequest finishes. With [MOD_INCLUDE](#) this could be any old #include, and the delay can be up to 3 seconds... and happened quite frequently. Instead the subprocess is registered in r->main->pool which causes it to be cleaned up when the entire request is done – *i.e.*, after the output has been sent to the client and logging has happened.

Tracking open files, etc.

As indicated above, resource pools are also used to track other sorts of resources besides memory. The most common are open files. The routine which is typically used for this is ap_pfdopen, which takes a resource pool and two strings as arguments; the strings are the same as the typical arguments to fopen, *e.g.*,

```
...
FILE *f = ap_pfdopen (r->pool, r->filename, "r");
if (f == NULL) { ... } else { ... }
```

There is also a ap_popenf routine, which parallels the lower-level open system call. Both of these routines arrange for the file to be closed when the resource pool in question is cleared.

Unlike the case for memory, there *are* functions to close files allocated with ap_pfdopen, and ap_popenf, namely ap_pfdclose and ap_pfdclosef. (This is because, on many systems, the number of files which a single process can have open is quite limited). It is important to use these functions to close files allocated with ap_pfdopen and ap_popenf, since to do otherwise could cause fatal errors on systems such as Linux, which react badly if the same FILE* is closed more than once.

(Using the close functions is not mandatory, since the file will eventually be closed regardless, but you should consider it in cases where your module is opening, or could open, a lot of files).

Other sorts of resources – cleanup functions

More text goes here. Describe the cleanup primitives in terms of which the file stuff is implemented; also, `spawn_process`.

Pool cleanups live until `clear_pool()` is called: `clear_pool(a)` recursively calls `destroy_pool()` on all subpools of `a`; then calls all the cleanups for `a`; then releases all the memory for `a`. `destroy_pool(a)` calls `clear_pool(a)` and then releases the pool structure itself. *i.e.*, `clear_pool(a)` doesn't delete `a`, it just frees up all the resources and you can start using it again immediately.

Fine control – creating and dealing with sub-pools, with a note on sub-requests

On rare occasions, too-free use of `ap_palloc()` and the associated primitives may result in undesirably profligate resource allocation. You can deal with such a case by creating a *sub-pool*, allocating within the sub-pool rather than the main pool, and clearing or destroying the sub-pool, which releases the resources which were associated with it. (This really *is* a rare situation; the only case in which it comes up in the standard module set is in case of listing directories, and then only with *very* large directories. Unnecessary use of the primitives discussed here can hair up your code quite a bit, with very little gain).

The primitive for creating a sub-pool is `ap_make_sub_pool`, which takes another pool (the parent pool) as an argument. When the main pool is cleared, the sub-pool will be destroyed. The sub-pool may also be cleared or destroyed at any time, by calling the functions `ap_clear_pool` and `ap_destroy_pool`, respectively. (The difference is that `ap_clear_pool` frees resources associated with the pool, while `ap_destroy_pool` also deallocates the pool itself. In the former case, you can allocate new resources within the pool, and clear it again, and so forth; in the latter case, it is simply gone).

One final note – sub-requests have their own resource pools, which are sub-pools of the resource pool for the main request. The polite way to reclaim the resources associated with a sub request which you have allocated (using the `ap_sub_req_...` functions) is `ap_destroy_sub_req`, which frees the resource pool. Before calling this function, be sure to copy anything that you care about which might be allocated in the sub-request's resource pool into someplace a little less volatile (for instance, the filename in its `request_rec` structure).

(Again, under most circumstances, you shouldn't feel obliged to call this function; only 2K of memory or so are allocated for a typical sub request, and it will be freed anyway when the main request pool is cleared. It is only when you are allocating many, many sub-requests for a single main request that you should seriously consider the `ap_destroy_...` functions).

Configuration, commands and the like

One of the design goals for this server was to maintain external compatibility with the NCSA 1.3 server — that is, to read the same configuration files, to process all the directives therein correctly, and in general to be a drop-in replacement for NCSA. On the other hand, another design goal was to move as much of the server's functionality into modules which have as little as possible to do with the monolithic server core. The only way to reconcile these goals is to move the handling of most commands from the central server into the modules.

However, just giving the modules command tables is not enough to divorce them completely from the server core. The server has to remember the commands in order to act on them later. That involves maintaining data which is private to the modules, and which can be either per-server, or per-directory. Most things are per-directory, including in particular access control and authorization information, but also information on how to determine file types from suffixes, which can be modified by `ADDTYPE` and `DEFAULTTYPE` directives, and so forth. In general, the governing philosophy is that anything which *can* be made configurable by directory should be; per-server information is generally used in the standard set of modules for information like `ALIASES` and `REDIRECTS` which come into play before the request is tied to a particular place in the underlying file system.

Another requirement for emulating the NCSA server is being able to handle the per-directory configuration files,

generally called `.htaccess` files, though even in the NCSA server they can contain directives which have nothing at all to do with access control. Accordingly, after URI -> filename translation, but before performing any other phase, the server walks down the directory hierarchy of the underlying filesystem, following the translated pathname, to read any `.htaccess` files which might be present. The information which is read in then has to be *merged* with the applicable information from the server's own config files (either from the `<DIRECTORY>` sections in `access.conf`, or from defaults in `srn.conf`, which actually behaves for most purposes almost exactly like `<Directory />`).

Finally, after having served a request which involved reading `.htaccess` files, we need to discard the storage allocated for handling them. That is solved the same way it is solved wherever else similar problems come up, by tying those structures to the per-transaction resource pool.

Per-directory configuration structures

Let's look out how all of this plays out in `mod_mime.c`, which defines the file typing handler which emulates the NCSA server's behavior of determining file types from suffixes. What we'll be looking at, here, is the code which implements the `ADDTYPE` and `ADDENCODING` commands. These commands can appear in `.htaccess` files, so they must be handled in the module's private per-directory data, which in fact, consists of two separate tables for MIME types and encoding information, and is declared as follows:

```
typedef struct {
    table *forced_types;      /* Additional AddTyped stuff */
    table *encoding_types;   /* Added with AddEncoding... */
} mime_dir_config;
```

When the server is reading a configuration file, or `<DIRECTORY>` section, which includes one of the MIME module's commands, it needs to create a `mime_dir_config` structure, so those commands have something to act on. It does this by invoking the function it finds in the module's 'create per-dir config slot', with two arguments: the name of the directory to which this configuration information applies (or `NULL` for `srn.conf`), and a pointer to a resource pool in which the allocation should happen.

(If we are reading a `.htaccess` file, that resource pool is the per-request resource pool for the request; otherwise it is a resource pool which is used for configuration data, and cleared on restarts. Either way, it is important for the structure being created to vanish when the pool is cleared, by registering a cleanup on the pool if necessary).

For the MIME module, the per-dir config creation function just `ap_pallocs` the structure above, and creates a couple of tables to fill it. That looks like this:

```
void *create_mime_dir_config (pool *p, char *dummy)
{
    mime_dir_config *new =
        (mime_dir_config *) ap_palloc (p, sizeof(mime_dir_config));

    new->forced_types = ap_make_table (p, 4);
    new->encoding_types = ap_make_table (p, 4);
    return new;
}
```

Now, suppose we've just read in a `.htaccess` file. We already have the per-directory configuration structure for the next directory up in the hierarchy. If the `.htaccess` file we just read in didn't have any `ADDTYPE` or `ADDENCODING` commands, its per-directory config structure for the MIME module is still valid, and we can just use it. Otherwise, we need to merge the two structures somehow.

To do that, the server invokes the module's per-directory config merge function, if one is present. That function takes three arguments: the two structures being merged, and a resource pool in which to allocate the result. For the MIME module, all that needs to be done is overlay the tables from the new per-directory config structure with those from the parent:

```
void *merge_mime_dir_configs (pool *p, void *parent_dirv, void
*subdirv)
{
    mime_dir_config *parent_dir = (mime_dir_config *)parent_dirv;
    mime_dir_config *subdir = (mime_dir_config *)subdirv;
    mime_dir_config *new =
        (mime_dir_config *)ap_palloc (p, sizeof(mime_dir_config));

    new->forced_types = ap_overlay_tables (p, subdir->forced_types,
        parent_dir->forced_types);
    new->encoding_types = ap_overlay_tables (p, subdir->encoding_types,
        parent_dir->encoding_types);

    return new;
}
```

As a note – if there is no per-directory merge function present, the server will just use the subdirectory's configuration info, and ignore the parent's. For some modules, that works just fine (*e.g.*, for the includes module, whose per-directory configuration information consists solely of the state of the XBITHACK), and for those modules, you can just not declare one, and leave the corresponding structure slot in the module itself NULL.

Command handling

Now that we have these structures, we need to be able to figure out how to fill them. That involves processing the actual [ADDTYPE](#) and [ADDENCODING](#) commands. To find commands, the server looks in the module's command table. That table contains information on how many arguments the commands take, and in what formats, where it is permitted, and so forth. That information is sufficient to allow the server to invoke most command-handling functions with pre-parsed arguments. Without further ado, let's look at the [ADDTYPE](#) command handler, which looks like this (the [ADDENCODING](#) command looks basically the same, and won't be shown here):

```
char *add_type(cmd_parms *cmd, mime_dir_config *m, char *ct, char *ext)
{
    if (*ext == '.') ++ext;
    ap_table_set (m->forced_types, ext, ct);
    return NULL;
}
```

This command handler is unusually simple. As you can see, it takes four arguments, two of which are pre-parsed arguments, the third being the per-directory configuration structure for the module in question, and the fourth being a pointer to a `cmd_parms` structure. That structure contains a bunch of arguments which are frequently of use to some, but not all, commands, including a resource pool (from which memory can be allocated, and to which cleanups should be tied), and the (virtual) server being configured, from which the module's per-server configuration data can be obtained if required.

Another way in which this particular command handler is unusually simple is that there are no error conditions which it can encounter. If there were, it could return an error message instead of NULL; this causes an error to be printed out

on the server's `stderr`, followed by a quick exit, if it is in the main config files; for a `.htaccess` file, the syntax error is logged in the server error log (along with an indication of where it came from), and the request is bounced with a server error response (HTTP error status, code 500).

The MIME module's command table has entries for these commands, which look like this:

```
command_rec mime_cmds[] = {
    { "AddType", add_type, NULL, OR_FILEINFO, TAKE2,
      "a mime type followed by a file extension" },
    { "AddEncoding", add_encoding, NULL, OR_FILEINFO, TAKE2,
      "an encoding (e.g., gzip), followed by a file extension" },
    { NULL }
};
```

The entries in these tables are:

- The name of the command
- The function which handles it
- a `(void *)` pointer, which is passed in the `cmd_parms` structure to the command handler — this is useful in case many similar commands are handled by the same function.
- A bit mask indicating where the command may appear. There are mask bits corresponding to each `AllowOverride` option, and an additional mask bit, `RSRC_CONF`, indicating that the command may appear in the server's own config files, but *not* in any `.htaccess` file.
- A flag indicating how many arguments the command handler wants pre-parsed, and how they should be passed in. `TAKE2` indicates two pre-parsed arguments. Other options are `TAKE1`, which indicates one pre-parsed argument, `FLAG`, which indicates that the argument should be `On` or `Off`, and is passed in as a boolean flag, `RAW_ARGS`, which causes the server to give the command the raw, unparsed arguments (everything but the command name itself). There is also `ITERATE`, which means that the handler looks the same as `TAKE1`, but that if multiple arguments are present, it should be called multiple times, and finally `ITERATE2`, which indicates that the command handler looks like a `TAKE2`, but if more arguments are present, then it should be called multiple times, holding the first argument constant.
- Finally, we have a string which describes the arguments that should be present. If the arguments in the actual config file are not as required, this string will be used to help give a more specific error message. (You can safely leave this `NULL`).

Finally, having set this all up, we have to use it. This is ultimately done in the module's handlers, specifically for its file-typing handler, which looks more or less like this; note that the per-directory configuration structure is extracted from the `request_rec`'s per-directory configuration vector by using the `ap_get_module_config` function.

```

int find_ct(request_rec *r)
{
    int i;
    char *fn = ap_pstrdup (r->pool, r->filename);
    mime_dir_config *conf = (mime_dir_config *)
        ap_get_module_config(r->per_dir_config, &mime_module);
    char *type;
    if (S_ISDIR(r->finfo.st_mode)) {
        r->content_type = DIRMAGIC_TYPE;
        return OK;
    }
    if((i=ap_rind(fn, '.')) < 0) return DECLINED;
    ++i;
    if ((type = ap_table_get (conf->encoding_types, &fn[i])))
    {
        r->content_encoding = type;
        /* go back to previous extension to try to use it as a type */
        fn[i-1] = '\0';
        if((i=ap_rind(fn, '.')) < 0) return OK;
        ++i;
    }
    if ((type = ap_table_get (conf->forced_types, &fn[i])))
    {
        r->content_type = type;
    }
    return OK;
}

```

Side notes – per-server configuration, virtual servers, etc.

The basic ideas behind per-server module configuration are basically the same as those for per-directory configuration; there is a creation function and a merge function, the latter being invoked where a virtual server has partially overridden the base server configuration, and a combined structure must be computed. (As with per-directory configuration, the default if no merge function is specified, and a module is configured in some virtual server, is that the base configuration is simply ignored).

The only substantial difference is that when a command needs to configure the per-server private module data, it needs to go to the `cmd_parms` data to get at it. Here's an example, from the `alias` module, which also indicates how a syntax error can be returned (note that the per-directory configuration argument to the command handler is declared as a dummy, since the module doesn't actually have per-directory config data):

```
char *add_redirect(cmd_parms *cmd, void *dummy, char *f, char *url)
{
    server_rec *s = cmd->server;
    alias_server_conf *conf = (alias_server_conf *)
        ap_get_module_config(s->module_config, &alias_module);
    alias_entry *new = ap_push_array (conf->redirects);
    if (!ap_is_url (url)) return "Redirect to non-URL";
    new->fake = f; new->real = url;
    return NULL;
}
```

11.3 Debugging Memory Allocation in APR

The allocation mechanism's within APR have a number of debugging modes that can be used to assist in finding memory problems. This document describes the modes available and gives instructions on activating them.

Available debugging options

Allocation Debugging - `ALLOC_DEBUG`

⇒ Debugging support: Define this to enable code which helps detect re-use of `free()`d memory and other such nonsense.

The theory is simple. The `FILL_BYTE` (`0xa5`) is written over all `malloc`'d memory as we receive it, and is written over everything that we free up during a `clear_pool`. We check that blocks on the free list always have the `FILL_BYTE` in them, and we check during `palloc()` that the bytes still have `FILL_BYTE` in them. If you ever see garbage URLs or whatnot containing lots of `0xa5`s then you know something used data that's been freed or uninitialized.

Malloc Support - `ALLOC_USE_MALLOC`

⇒ If defined all allocations will be done with `malloc()` and `free()`d appropriately at the end.

This is intended to be used with something like Electric Fence or Purify to help detect memory problems. Note that if you're using `efence` then you should also add in `ALLOC_DEBUG`. But don't add in `ALLOC_DEBUG` if you're using Purify because `ALLOC_DEBUG` would hide all the uninitialized read errors that Purify can diagnose.

Pool Debugging - `POOL_DEBUG`

⇒ This is intended to detect cases where the wrong pool is used when assigning data to an object in another pool.

In particular, it causes the `table_{set,add,merge}`n routines to check that their arguments are safe for the `apr_table_t` they're being placed in. It currently only works with the unix multiprocess model, but could be extended to others.

Table Debugging - `MAKE_TABLE_PROFILE`

⇒ Provide diagnostic information about `make_table()` calls which are possibly too small.

This requires a recent gcc which supports `__builtin_return_address()`. The `error_log` output will be a message such as:

```
table_push: apr_table_t created by 0x804d874 hit limit of 10
```

Use `l *0x804d874` to find the source that corresponds to. It indicates that a `apr_table_t` allocated by a call at that address has possibly too small an initial `apr_table_t` size guess.

Allocation Statistics - ALLOC_STATS

⇒ Provide some statistics on the cost of allocations.

This requires a bit of an understanding of how alloc.c works.

Allowable Combinations

Not all the options outlined above can be activated at the same time. the following table gives more information.

	ALLOC DEBUG	ALLOC USE MALLOC	POOL DEBUG	MAKE TABLE PROFILE	ALLOC STATS
ALLOC DEBUG	-	No	Yes	Yes	Yes
ALLOC USE MALLOC	No	-	No	No	No
POOL DEBUG	Yes	No	-	Yes	Yes
MAKE TABLE PROFILE	Yes	No	Yes	-	Yes
ALLOC STATS	Yes	No	Yes	Yes	-

Additionally the debugging options are not suitable for multi-threaded versions of the server. When trying to debug with these options the server should be started in single process mode.

Activating Debugging Options

The various options for debugging memory are now enabled in the `apr_general.h` header file in APR. The various options are enabled by uncommenting the define for the option you wish to use. The section of the code currently looks like this (*contained in `srclib/apr/include/apr_pools.h`*)

```
/*
#define ALLOC_DEBUG
#define POOL_DEBUG
#define ALLOC_USE_MALLOC
#define MAKE_TABLE_PROFILE
#define ALLOC_STATS
/
typedef struct ap_pool_t {
    union block_hdr *first;
    union block_hdr *last;
    struct cleanup *cleanups;
    struct process_chain *subprocesses;
    struct ap_pool_t *sub_pools;
    struct ap_pool_t *sub_next;
    struct ap_pool_t *sub_prev;
    struct ap_pool_t *parent;
    char *free_first_avail;
#ifdef ALLOC_USE_MALLOC
    void *allocation_list;
#endif
#ifdef POOL_DEBUG
    struct ap_pool_t *joined;
#endif
    int (*apr_abort)(int retcode);
    struct datastruct *prog_data;
} ap_pool_t;
```

To enable allocation debugging simply move the `#define ALLOC_DEBUG` above the start of the comments block and rebuild the server.

⇒ **Note**

In order to use the various options the server **must** be rebuilt after editing the header file.

11.4 Documenting Apache 2.0

Apache 2.0 uses Doxygen⁷ to document the APIs and global variables in the code. This will explain the basics of how to document using Doxygen.

Brief Description

To start a documentation block, use `/**`

To end a documentation block, use `*/`

In the middle of the block, there are multiple tags we can use:

```
Description of this functions purpose
@param parameter_name description
@return description
@deffunc signature of the function
```

The `deffunc` is not always necessary. DoxyGen does not have a full parser in it, so any prototype that use a macro in the return type declaration is too complex for scandoc. Those functions require a `deffunc`. An example (using `>`; rather than `>`):

```
/**
 * return the final element of the pathname
 * @param pathname The path to get the final element of
 * @return the final element of the path
 * @tip Examples:
 * <pre>
 * "/foo/bar/gum" -&gt; "gum"
 * "/foo/bar/gum/" -&gt; ""
 * "gum" -&gt; "gum"
 * "wi\n32\stuff" -&gt; "stuff"
 * </pre>
 * @deffunc const char * ap_filename_of_pathname(const char *pathname)
 */
```

At the top of the header file, always include:

```
/**
 * @package Name of library header
 */
```

Doxygen uses a new HTML file for each package. The HTML files are named `{Name_of_library_header}.html`, so try to be concise with your names.

For a further discussion of the possibilities please refer to the Doxygen site⁸.

⁷<http://www.doxygen.org/>

⁸<http://www.doxygen.org/>

11.5 Apache 2.0 Hook Functions



Warning

This document is still in development and may be partially out of date.

In general, a hook function is one that Apache will call at some point during the processing of a request. Modules can provide functions that are called, and specify when they get called in comparison to other modules.

Creating a hook function

In order to create a new hook, four things need to be done:

Declare the hook function

Use the `AP_DECLARE_HOOK` macro, which needs to be given the return type of the hook function, the name of the hook, and the arguments. For example, if the hook returns an `int` and takes a `request_rec *` and an `int` and is called `do_something`, then declare it like this:

```
AP_DECLARE_HOOK(int, do_something, (request_rec *r, int n))
```

This should go in a header which modules will include if they want to use the hook.

Create the hook structure

Each source file that exports a hook has a private structure which is used to record the module functions that use the hook. This is declared as follows:

```
APR_HOOK_STRUCT (
    APR_HOOK_LINK(do_something)
    ...
)
```

Implement the hook caller

The source file that exports the hook has to implement a function that will call the hook. There are currently three possible ways to do this. In all cases, the calling function is called `ap_run_hookname()`.

Void hooks

If the return value of a hook is `void`, then all the hooks are called, and the caller is implemented like this:

```
AP_IMPLEMENT_HOOK_VOID(do_something, (request_rec *r, int n), (r, n))
```

The second and third arguments are the dummy argument declaration and the dummy arguments as they will be used when calling the hook. In other words, this macro expands to something like this:

```
void ap_run_do_something(request_rec *r, int n)
{
    ...
    do_something(r, n);
}
```

Hooks that return a value

If the hook returns a value, then it can either be run until the first hook that does something interesting, like so:

```
AP_IMPLEMENT_HOOK_RUN_FIRST(int, do_something, (request_rec *r, int n),
(r, n), DECLINED)
```

The first hook that does *not* return DECLINED stops the loop and its return value is returned from the hook caller. Note that DECLINED is the tradition Apache hook return meaning "I didn't do anything", but it can be whatever suits you.

Alternatively, all hooks can be run until an error occurs. This boils down to permitting *two* return values, one of which means "I did something, and it was OK" and the other meaning "I did nothing". The first function that returns a value other than one of those two stops the loop, and its return is the return value. Declare these like so:

```
AP_IMPLEMENT_HOOK_RUN_ALL(int, do_something, (request_rec *r, int n),
(r, n), OK, DECLINED)
```

Again, OK and DECLINED are the traditional values. You can use what you want.

Call the hook callers

At appropriate moments in the code, call the hook caller, like so:

```
int n, ret;
request_rec *r;
ret=ap_run_do_something(r, n);
```

Hooking the hook

A module that wants a hook to be called needs to do two things.

Implement the hook function

Include the appropriate header, and define a static function of the correct type:

```
static int my_something_doer(request_rec *r, int n)
{
    ...
    return OK;
}
```

Add a hook registering function

During initialisation, Apache will call each modules hook registering function, which is included in the module structure:

```
static void my_register_hooks()
{
    ap_hook_do_something(my_something_doer, NULL, NULL, HOOK_MIDDLE);
}
mode MODULE_VAR_EXPORT my_module =
{
    ...
    my_register_hooks /* register hooks */
};
```

Controlling hook calling order

In the example above, we didn't use the three arguments in the hook registration function that control calling order. There are two mechanisms for doing this. The first, rather crude, method, allows us to specify roughly where the hook is run relative to other modules. The final argument control this. There are three possible values: `HOOK_FIRST`, `HOOK_MIDDLE` and `HOOK_LAST`.

All modules using any particular value may be run in any order relative to each other, but, of course, all modules using `HOOK_FIRST` will be run before `HOOK_MIDDLE` which are before `HOOK_LAST`. Modules that don't care when they are run should use `HOOK_MIDDLE`. (*I spaced these out so people could do stuff like `HOOK_FIRST-2` to get in slightly earlier, but is this wise? - Ben*)

Note that there are two more values, `HOOK_REALLY_FIRST` and `HOOK_REALLY_LAST`. These should only be used by the hook exporter.

The other method allows finer control. When a module knows that it must be run before (or after) some other modules, it can specify them by name. The second (third) argument is a `NULL`-terminated array of strings consisting of the names of modules that must be run before (after) the current module. For example, suppose we want "mod_xyz.c" and "mod_abc.c" to run before we do, then we'd hook as follows:

```
static void register_hooks()
{
    static const char * const aszPre[] = { "mod_xyz.c", "mod_abc.c",
    NULL };
    ap_hook_do_something(my_something_doer, aszPre, NULL, HOOK_MIDDLE);
}
```

Note that the sort used to achieve this is stable, so ordering set by `HOOK_ORDER` is preserved, as far as is possible.

Ben Laurie, 15th August 1999

11.6 Converting Modules from Apache 1.3 to Apache 2.0

This is a first attempt at writing the lessons I learned when trying to convert the `mod_mmap_static` module to Apache 2.0. It's by no means definitive and probably won't even be correct in some ways, but it's a start.

The easier changes ...

Cleanup Routines

These now need to be of type `apr_status_t` and return a value of that type. Normally the return value will be `APR_SUCCESS` unless there is some need to signal an error in the cleanup. Be aware that even though you signal an error not all code yet checks and acts upon the error.

Initialisation Routines

These should now be renamed to better signify where they sit in the overall process. So the name gets a small change from `mmap_init` to `mmap_post_config`. The arguments passed have undergone a radical change and now look like

- `apr_pool_t *p`
- `apr_pool_t *plog`
- `apr_pool_t *ptemp`
- `server_rec *s`

Data Types

A lot of the data types have been moved into the APR⁹. This means that some have had a name change, such as the one shown above. The following is a brief list of some of the changes that you are likely to have to make.

- `pool` becomes `apr_pool_t`
- `table` becomes `apr_table_t`

The messier changes...

Register Hooks

The new architecture uses a series of hooks to provide for calling your functions. These you'll need to add to your module by way of a new function, `static void register_hooks(void)`. The function is really reasonably straightforward once you understand what needs to be done. Each function that needs calling at some stage in the processing of a request needs to be registered, handlers do not. There are a number of phases where functions can be added, and for each you can specify with a high degree of control the relative order that the function will be called in.

This is the code that was added to `mod_mmap_static`:

⁹<http://apr.apache.org/>

```
static void register_hooks(void)
{
    static const char * const aszPre[]={ "http_core.c",NULL };
    ap_hook_post_config(mmap_post_config,NULL,NULL,HOOK_MIDDLE);
    ap_hook_translate_name(mmap_static_xlat,aszPre,NULL,HOOK_LAST);
};
```

This registers 2 functions that need to be called, one in the `post_config` stage (virtually every module will need this one) and one for the `translate_name` phase. note that while there are different function names the format of each is identical. So what is the format?

```
ap_hook_phase_name(function_name, predecessors, successors, position);
```

There are 3 hook positions defined...

- HOOK_FIRST
- HOOK_MIDDLE
- HOOK_LAST

To define the position you use the position and then modify it with the predecessors and successors. Each of the modifiers can be a list of functions that should be called, either before the function is run (predecessors) or after the function has run (successors).

In the `mod_mmap_static` case I didn't care about the `post_config` stage, but the `mmap_static_xlat` **must** be called after the core module had done it's name translation, hence the use of the `aszPre` to define a modifier to the position `HOOK_LAST`.

Module Definition

There are now a lot fewer stages to worry about when creating your module definition. The old defintion looked like

```

module MODULE_VAR_EXPORT module_name_module =
{
    STANDARD_MODULE_STUFF,
    /* initializer */
    /* dir config creator */
    /* dir merger --- default is to override */
    /* server config */
    /* merge server config */
    /* command handlers */
    /* handlers */
    /* filename translation */
    /* check_user_id */
    /* check auth */
    /* check access */
    /* type_checker */
    /* fixups */
    /* logger */
    /* header parser */
    /* child_init */
    /* child_exit */
    /* post read-request */
};

```

The new structure is a great deal simpler...

```

module MODULE_VAR_EXPORT module_name_module =
{
    STANDARD20_MODULE_STUFF,
    /* create per-directory config structures */
    /* merge per-directory config structures */
    /* create per-server config structures */
    /* merge per-server config structures */
    /* command handlers */
    /* handlers */
    /* register hooks */
};

```

Some of these read directly across, some don't. I'll try to summarise what should be done below.

The stages that read directly across :

```

/* dir config creator */ /* create per-directory config structures */
/* server config */ /* create per-server config structures */
/* dir merger */ /* merge per-directory config structures */
/* merge server config */ /* merge per-server config structures */
/* command table */ /* command apr_table_t */
/* handlers */ /* handlers */

```

The remainder of the old functions should be registered as hooks. There are the following hook stages defined so far...

ap_hook_post_config this is where the old `_init` routines get registered

ap_hook_http_method retrieve the http method from a request. (legacy)

ap_hook_open_logs open any specified logs

ap_hook_auth_checker check if the resource requires authorization

ap_hook_access_checker check for module-specific restrictions

ap_hook_check_user_id check the user-id and password

ap_hook_default_port retrieve the default port for the server

ap_hook_pre_connection do any setup required just before processing, but after accepting

ap_hook_process_connection run the correct protocol

ap_hook_child_init call as soon as the child is started

ap_hook_create_request ??

ap_hook_fixups last chance to modify things before generating content

ap_hook_handler generate the content

ap_hook_header_parser lets modules look at the headers, not used by most modules, because they use `post_read_request` for this

ap_hook_insert_filter to insert filters into the filter chain

ap_hook_log_transaction log information about the request

ap_hook_optional_fn_retrieve retrieve any functions registered as optional

ap_hook_post_read_request called after reading the request, before any other phase

ap_hook_quick_handler called before any request processing, used by cache modules.

ap_hook_translate_name translate the URI into a filename

ap_hook_type_checker determine and/or set the doc type

11.7 Request Processing in Apache 2.0



Warning

Warning - this is a first (fast) draft that needs further revision!

Several changes in Apache 2.0 affect the internal request processing mechanics. Module authors need to be aware of these changes so they may take advantage of the optimizations and security enhancements.

The first major change is to the subrequest and redirect mechanisms. There were a number of different code paths in Apache 1.3 to attempt to optimize subrequest or redirect behavior. As patches were introduced to 2.0, these optimizations (and the server behavior) were quickly broken due to this duplication of code. All duplicate code has been folded back into `ap_process_request_internal()` to prevent the code from falling out of sync again.

This means that much of the existing code was 'unoptimized'. It is the Apache HTTP Project's first goal to create a robust and correct implementation of the HTTP server RFC. Additional goals include security, scalability and optimization. New methods were sought to optimize the server (beyond the performance of Apache 1.3) without introducing fragile or insecure code.

The Request Processing Cycle

All requests pass through `ap_process_request_internal()` in `request.c`, including subrequests and redirects. If a module doesn't pass generated requests through this code, the author is cautioned that the module may be broken by future changes to request processing.

To streamline requests, the module author can take advantage of the hooks offered to drop out of the request cycle early, or to bypass core Apache hooks which are irrelevant (and costly in terms of CPU.)

The Request Parsing Phase

Unescapes the URL

The request's `parseduri` path is unescaped, once and only once, at the beginning of internal request processing.

This step is bypassed if the `proxyreq` flag is set, or the `parseduri.path` element is unset. The module has no further control of this one-time unescape operation, either failing to unescape or multiply unescaping the URL leads to security repercussions.

Strips Parent and This Elements from the URI

All `../` and `/./` elements are removed by `ap_getparents()`. This helps to ensure the path is (nearly) absolute before the request processing continues.

This step cannot be bypassed.

Initial URI Location Walk

Every request is subject to an `ap_location_walk()` call. This ensures that `<LOCATION>` sections are consistently enforced for all requests. If the request is an internal redirect or a sub-request, it may borrow some or all of the processing from the previous or parent request's `ap_location_walk`, so this step is generally very efficient after processing the main request.

translate_name

Modules can determine the file name, or alter the given URI in this step. For example, `MOD_VHOST_ALIAS` will translate the URI's path into the configured virtual host, `MOD_ALIAS` will translate the path to an alias path, and if the request falls back on the core, the `DOCUMENTROOT` is prepended to the request resource.

If all modules `DECLINE` this phase, an error 500 is returned to the browser, and a "couldn't translate name" error is logged automatically.

Hook: map_to_storage

After the file or correct URI was determined, the appropriate per-dir configurations are merged together. For example, `MOD_PROXY` compares and merges the appropriate `<PROXY>` sections. If the URI is nothing more than a local (non-proxy) `TRACE` request, the core handles the request and returns `DONE`. If no module answers this hook with `OK` or `DONE`, the core will run the request filename against the `<DIRECTORY>` and `<FILES>` sections. If the request 'filename' isn't an absolute, legal filename, a note is set for later termination.

URI Location Walk

Every request is hardened by a second `ap_location_walk()` call. This reassures that a translated request is still subjected to the configured `<LOCATION>` sections. The request again borrows some or all of the processing from its previous `location_walk` above, so this step is almost always very efficient unless the translated URI mapped to a substantially different path or Virtual Host.

Hook: header_parser

The main request then parses the client's headers. This prepares the remaining request processing steps to better serve the client's request.

The Security Phase

Needs Documentation. Code is:

```

switch (ap_satisfies(r)) {
case SATISFY_ALL:
case SATISFY_NOSPEC:
    if ((access_status = ap_run_access_checker(r)) != 0) {
        return decl_die(access_status, "check access", r);
    }

    if (ap_some_auth_required(r)) {
        if (((access_status = ap_run_check_user_id(r)) != 0)
            || !ap_auth_type(r)) {
            return decl_die(access_status, ap_auth_type(r)
                ? "check user. No user file?"
                : "perform authentication. AuthType not set!",
                r);
        }

        if (((access_status = ap_run_auth_checker(r)) != 0)
            || !ap_auth_type(r)) {
            return decl_die(access_status, ap_auth_type(r)
                ? "check access. No groups file?"
                : "perform authentication. AuthType not set!",
                r);
        }
    }
    break;

case SATISFY_ANY:
    if (((access_status = ap_run_access_checker(r)) != 0) {
        if (!ap_some_auth_required(r)) {
            return decl_die(access_status, "check access", r);
        }

        if (((access_status = ap_run_check_user_id(r)) != 0)
            || !ap_auth_type(r)) {
            return decl_die(access_status, ap_auth_type(r)
                ? "check user. No user file?"
                : "perform authentication. AuthType not set!",
                r);
        }

        if (((access_status = ap_run_auth_checker(r)) != 0)
            || !ap_auth_type(r)) {
            return decl_die(access_status, ap_auth_type(r)
                ? "check access. No groups file?"
                : "perform authentication. AuthType not set!",
                r);
        }
    }
    break;
}

```

The Preparation Phase

Hook: `type_checker`

The modules have an opportunity to test the URI or filename against the target resource, and set mime information for the request. Both `MOD_MIME` and `MOD_MIME_MAGIC` use this phase to compare the file name or contents against the administrator's configuration and set the content type, language, character set and request handler. Some modules may set up their filters or other request handling parameters at this time.

If all modules `DECLINE` this phase, an error 500 is returned to the browser, and a "couldn't find types" error is logged automatically.

Hook: `fixups`

Many modules are 'trounced' by some phase above. The `fixups` phase is used by modules to 'reassert' their ownership or force the request's fields to their appropriate values. It isn't always the cleanest mechanism, but occasionally it's the only option.

The Handler Phase

This phase is **not** part of the processing in `ap_process_request_internal()`. Many modules prepare one or more subrequests prior to creating any content at all. After the core, or a module calls `ap_process_request_internal()` it then calls `ap_invoke_handler()` to generate the request.

Hook: `insert_filter`

Modules that transform the content in some way can insert their values and override existing filters, such that if the user configured a more advanced filter out-of-order, then the module can move its order as need be. There is no result code, so actions in this hook better be trusted to always succeed.

Hook: `handler`

The module finally has a chance to serve the request in its handler hook. Note that not every prepared request is sent to the handler hook. Many modules, such as `MOD_AUTOINDEX`, will create subrequests for a given URI, and then never serve the subrequest, but simply lists it for the user. Remember not to put required teardown from the hooks above into this module, but register pool cleanups against the request pool to free resources as required.

11.8 How filters work in Apache 2.0



Warning

This is a cut 'n paste job from an email (<022501c1c529\$f63a9550\$7f00000a@KOJ>) and only reformatted for better readability. It's not up to date but may be a good start for further research.

Filter Types

There are three basic filter types (each of these is actually broken down into two categories, but that comes later).

CONNECTION Filters of this type are valid for the lifetime of this connection. (`AP_FTYPE_CONNECTION`, `AP_FTYPE_NETWORK`)

PROTOCOL Filters of this type are valid for the lifetime of this request from the point of view of the client, this means that the request is valid from the time that the request is sent until the time that the response is received. (`AP_FTYPE_PROTOCOL`, `AP_FTYPE_TRANSCODE`)

RESOURCE Filters of this type are valid for the time that this content is used to satisfy a request. For simple requests, this is identical to `PROTOCOL`, but internal redirects and sub-requests can change the content without ending the request. (`AP_FTYPE_RESOURCE`, `AP_FTYPE_CONTENT_SET`)

It is important to make the distinction between a protocol and a resource filter. A resource filter is tied to a specific resource, it may also be tied to header information, but the main binding is to a resource. If you are writing a filter and you want to know if it is resource or protocol, the correct question to ask is: "Can this filter be removed if the request is redirected to a different resource?" If the answer is yes, then it is a resource filter. If it is no, then it is most likely a protocol or connection filter. I won't go into connection filters, because they seem to be well understood. With this definition, a few examples might help:

Byterange We have coded it to be inserted for all requests, and it is removed if not used. Because this filter is active at the beginning of all requests, it can not be removed if it is redirected, so this is a protocol filter.

http_header This filter actually writes the headers to the network. This is obviously a required filter (except in the asis case which is special and will be dealt with below) and so it is a protocol filter.

Deflate The administrator configures this filter based on which file has been requested. If we do an internal redirect from an autoindex page to an index.html page, the deflate filter may be added or removed based on config, so this is a resource filter.

The further breakdown of each category into two more filter types is strictly for ordering. We could remove it, and only allow for one filter type, but the order would tend to be wrong, and we would need to hack things to make it work. Currently, the `RESOURCE` filters only have one filter type, but that should change.

How are filters inserted?

This is actually rather simple in theory, but the code is complex. First of all, it is important that everybody realize that there are three filter lists for each request, but they are all concatenated together. So, the first list is `r->output_filters`, then `r->proto_output_filters`, and finally `r->connection->output_filters`. These correspond to the `RESOURCE`, `PROTOCOL`, and `CONNECTION` filters respectively. The problem previously, was that we used a singly linked list to create the filter stack, and we started from the "correct" location. This means that if I had a `RESOURCE` filter on the stack, and I added a

CONNECTION filter, the CONNECTION filter would be ignored. This should make sense, because we would insert the connection filter at the top of the `c->output_filters` list, but the end of `r->output_filters` pointed to the filter that used to be at the front of `c->output_filters`. This is obviously wrong. The new insertion code uses a doubly linked list. This has the advantage that we never lose a filter that has been inserted. Unfortunately, it comes with a separate set of headaches.

The problem is that we have two different cases where we use subrequests. The first is to insert more data into a response. The second is to replace the existing response with an internal redirect. These are two different cases and need to be treated as such.

In the first case, we are creating the subrequest from within a handler or filter. This means that the next filter should be passed to `make_sub_request` function, and the last resource filter in the sub-request will point to the next filter in the main request. This makes sense, because the sub-request's data needs to flow through the same set of filters as the main request. A graphical representation might help:

```
Default_handler --> includes_filter --> byterange --> ...
```

If the includes filter creates a sub request, then we don't want the data from that sub-request to go through the includes filter, because it might not be SSI data. So, the subrequest adds the following:

```
Default_handler --> includes_filter -/-> byterange --> ...
                               /
Default_handler --> sub_request_core
```

What happens if the subrequest is SSI data? Well, that's easy, the `includes_filter` is a resource filter, so it will be added to the sub request in between the `Default_handler` and the `sub_request_core` filter.

The second case for sub-requests is when one sub-request is going to become the real request. This happens whenever a sub-request is created outside of a handler or filter, and NULL is passed as the next filter to the `make_sub_request` function.

In this case, the resource filters no longer make sense for the new request, because the resource has changed. So, instead of starting from scratch, we simply point the front of the resource filters for the sub-request to the front of the protocol filters for the old request. This means that we won't lose any of the protocol filters, neither will we try to send this data through a filter that shouldn't see it.

The problem is that we are using a doubly-linked list for our filter stacks now. But, you should notice that it is possible for two lists to intersect in this model. So, how do you handle the previous pointer? This is a very difficult question to answer, because there is no "right" answer, either method is equally valid. I looked at why we use the previous pointer. The only reason for it is to allow for easier addition of new servers. With that being said, the solution I chose was to make the previous pointer always stay on the original request.

This causes some more complex logic, but it works for all cases. My concern in having it move to the sub-request, is that for the more common case (where a sub-request is used to add data to a response), the main filter chain would be wrong. That didn't seem like a good idea to me.

Asis

The final topic. :-) `Mod_Asis` is a bit of a hack, but the handler needs to remove all filters except for connection filters, and send the data. If you are using `MOD_ASIS`, all other bets are off.

Explanations

The absolutely last point is that the reason this code was so hard to get right, was because we had hacked so much to force it to work. I wrote most of the hacks originally, so I am very much to blame. However, now that the code is right, I have started to remove some hacks. Most people should have seen that the `reset_filters` and `add_required_filters` functions are gone. Those inserted protocol level filters for error conditions, in fact, both functions did the same thing, one after the other, it was really strange. Because we don't lose protocol filters for error cases any more, those hacks went away. The `HTTP_HEADER`, `Content-length`, and `Byterange` filters are all added in the `insert_filters` phase, because if they were added earlier, we had some interesting interactions. Now, those could all be moved to be inserted with the `HTTP_IN`, `CORE`, and `CORE_IN` filters. That would make the code easier to follow.

Chapter 12

Glossary and Index

12.1 Glossary

This glossary defines some of the common terminology related to Apache in particular, and web serving in general. More information on each concept is provided in the links.

Definitions

Access Control The restriction of access to network realms. In an Apache context usually the restriction of access to certain *URLs*.

See: Authentication, Authorization, and Access Control (p. 181)

Algorithm An unambiguous formula or set of rules for solving a problem in a finite number of steps. Algorithms for encryption are usually called Ciphers.

APache eXtension Tool (apxs) A perl script that aids in compiling module sources into Dynamic Shared Objects (DSOs) and helps install them in the Apache Web server.

See: Manual Page: apxs

Authentication The positive identification of a network entity such as a server, a client, or a user.

See: Authentication, Authorization, and Access Control (p. 181)

Certificate A data record used for authenticating network entities such as a server or a client. A certificate contains X.509 information pieces about its owner (called the subject) and the signing Certification Authority (called the issuer), plus the owner's public key and the signature made by the CA. Network entities verify these signatures using CA certificates.

See: SSL/TLS Encryption (p. 146)

Certificate Signing Request (CSR) An unsigned certificate for submission to a Certification Authority, which signs it with the Private Key of their CA *Certificate*. Once the CSR is signed, it becomes a real certificate.

See: SSL/TLS Encryption (p. 146)

Certification Authority (CA) A trusted third party whose purpose is to sign certificates for network entities it has authenticated using secure means. Other network entities can check the signature to verify that a CA has authenticated the bearer of a certificate.

See: SSL/TLS Encryption (p. 146)

Cipher An algorithm or system for data encryption. Examples are DES, IDEA, RC4, etc.

See: SSL/TLS Encryption (p. 146)

Ciphertext The result after Plaintext is passed through a Cipher.

See: SSL/TLS Encryption (p. 146)

Common Gateway Interface (CGI) A standard definition for an interface between a web server and an external program that allows the external program to service requests. The interface was originally defined by NCSA¹ but there is also an RFC project².

See: Dynamic Content with CGI (p. 185)

Configuration Directive See: Directive

Configuration File A text file containing Directives that control the configuration of Apache.

See: Configuration Files (p. 19)

CONNECT An HTTP method for proxying raw data channels over HTTP. It can be used to encapsulate other protocols, such as the SSL protocol.

¹<http://hoohoo.ncsa.uiuc.edu/cgi/overview.html>

²<http://cgi-spec.golux.com/>

Context An area in the configuration files where certain types of directives are allowed.

See: Terms Used to Describe Apache Directives (p. 299)

Digital Signature An encrypted text block that validates a certificate or other file. A Certification Authority creates a signature by generating a hash of the *Public Key* embedded in a *Certificate*, then encrypting the hash with its own *Private Key*. Only the CA's public key can decrypt the signature, verifying that the CA has authenticated the network entity that owns the *Certificate*.

See: SSL/TLS Encryption (p. 146)

Directive A configuration command that controls one or more aspects of Apache's behavior. Directives are placed in the Configuration File

See: Directive Index (p. 663)

Dynamic Shared Object (DSO) Modules compiled separately from the Apache httpd binary that can be loaded on-demand.

See: Dynamic Shared Object Support (p. 44)

Environment Variable (env-variable) Named variables managed by the operating system shell and used to store information and communicate between programs. Apache also contains internal variables that are referred to as environment variables, but are stored in internal Apache structures, rather than in the shell environment.

See: Environment Variables in Apache (p. 60)

Export-Crippled Diminished in cryptographic strength (and security) in order to comply with the United States' Export Administration Regulations (EAR). Export-crippled cryptographic software is limited to a small key size, resulting in *Ciphertext* which usually can be decrypted by brute force.

See: SSL/TLS Encryption (p. 146)

Filter A process that is applied to data that is sent or received by the server. Input filters process data sent by the client to the server, while output filters process documents on the server before they are sent to the client. For example, the INCLUDES output filter processes documents for Server Side Includes.

See: Filters (p. 67)

Fully-Qualified Domain-Name (FQDN) The unique name of a network entity, consisting of a hostname and a domain name that can resolve to an IP address. For example, www is a hostname, example.com is a domain name, and www.example.com is a fully-qualified domain name.

Handler An internal Apache representation of the action to be performed when a file is called. Generally, files have implicit handlers, based on the file type. Normally, all files are simply served by the server, but certain file types are "handled" separately. For example, the `cgi-script` handler designates files to be processed as CGIs.

See: Apache's Handler Use (p. 65)

Hash A mathematical one-way, irreversable algorithm generating a string with fixed-length from another string of any length. Different input strings will usually produce different hashes (depending on the hash function).

Header The part of the HTTP request and response that is sent before the actual content, and that contains meta-information describing the content.

.htaccess A configuration file that is placed inside the web tree and applies configuration directives to the directory where it is placed and all sub-directories. Despite its name, this file can hold almost any type of directive, not just access-control directives.

See: Configuration Files (p. 19)

httpd.conf The main Apache configuration file. The default location is `/usr/local/apache2/conf/httpd.conf`, but it may be moved using run-time or compile-time configuration.

See: Configuration Files (p. 19)

HyperText Transfer Protocol (HTTP) The standard transmission protocol used on the World Wide Web. Apache implements version 1.1 of the protocol, referred to as HTTP/1.1 and defined by RFC 2616³.

HTTPS The HyperText Transfer Protocol (Secure), the standard encrypted communication mechanism on the World Wide Web. This is actually just HTTP over SSL.
See: SSL/TLS Encryption (p. 146)

Method In the context of HTTP, an action to perform on a resource, specified on the request line by the client. Some of the methods available in HTTP are GET, POST, and PUT.

Message Digest A hash of a message, which can be used to verify that the contents of the message have not been altered in transit.
See: SSL/TLS Encryption (p. 146)

MIME-type A way to describe the kind of document being transmitted. Its name comes from that fact that its format is borrowed from the Multipurpose Internet Mail Extensions. It consists of a major type and a minor type, separated by a slash. Some examples are `text/html`, `image/gif`, and `application/octet-stream`. In HTTP, the MIME-type is transmitted in the `Content-Type` header.
See: `mod_mime` (p. 483)

Module An independent part of a program. Much of Apache's functionality is contained in modules that you can choose to include or exclude. Modules that are compiled into the Apache `httpd` binary are called static modules, while modules that are stored separately and can be optionally loaded at run-time are called dynamic modules or DSOs. Modules that are included by default are called base modules. Many modules are available for Apache that are not distributed as part of the Apache HTTP Server tarball. These are referred to as third-party modules.
See: Module Index (p. 660)

Module Magic Number (MMN) Module Magic Number is a constant defined in the Apache source code that is associated with binary compatibility of modules. It is changed when internal Apache structures, function calls and other significant parts of API change in such a way that binary compatibility cannot be guaranteed any more. On MMN change, all third party modules have to be at least recompiled, sometimes even slightly changed in order to work with the new version of Apache.

OpenSSL The Open Source toolkit for SSL/TLS
See <http://www.openssl.org/#>

Pass Phrase The word or phrase that protects private key files. It prevents unauthorized users from encrypting them. Usually it's just the secret encryption/decryption key used for Ciphers.
See: SSL/TLS Encryption (p. 146)

Plaintext The unencrypted text.

Private Key The secret key in a Public Key Cryptography system, used to decrypt incoming messages and sign outgoing ones.
See: SSL/TLS Encryption (p. 146)

Proxy An intermediate server that sits between the client and the *origin server*. It accepts requests from clients, transmits those requests on to the origin server, and then returns the response from the origin server to the client. If several clients request the same content, the proxy can deliver that content from its cache, rather than requesting it from the origin server each time, thereby reducing response time.
See: `mod_proxy` (p. 504)

Public Key The publicly available key in a Public Key Cryptography system, used to encrypt messages bound for its owner and to decrypt signatures made by its owner.
See: SSL/TLS Encryption (p. 146)

³<http://ietf.org/rfc/rfc2616.txt>

Public Key Cryptography The study and application of asymmetric encryption systems, which use one key for encryption and another for decryption. A corresponding pair of such keys constitutes a key pair. Also called Asymmetric Cryptography.

See: SSL/TLS Encryption (p. 146)

Regular Expression (Regex) A way of describing a pattern in text - for example, "all the words that begin with the letter A" or "every 10-digit phone number" or even "Every sentence with two commas in it, and no capital letter Q". Regular expressions are useful in Apache because they let you apply certain attributes against collections of files or resources in very flexible ways - for example, all .gif and .jpg files under any "images" directory could be written as `"/images/.*(jpg|gif)$"`. Apache uses Perl Compatible Regular Expressions provided by the PCRE⁴ library.

Reverse Proxy A proxy server that appears to the client as if it is an *origin server*. This is useful to hide the real origin server from the client for security reasons, or to load balance.

Secure Sockets Layer (SSL) A protocol created by Netscape Communications Corporation for general communication authentication and encryption over TCP/IP networks. The most popular usage is *HTTPS*, i.e. the HyperText Transfer Protocol (HTTP) over SSL.

See: SSL/TLS Encryption (p. 146)

Server Side Includes (SSI) A technique for embedding processing directives inside HTML files.

See: Introduction to Server Side Includes (p. 191)

Session The context information of a communication in general.

SSLey The original SSL/TLS implementation library developed by Eric A. Young

Symmetric Cryptography The study and application of *Ciphers* that use a single secret key for both encryption and decryption operations.

See: SSL/TLS Encryption (p. 146)

Tarball A package of files gathered together using the `tar` utility. Apache distributions are stored in compressed tar archives or using `pkzip`.

Transport Layer Security (TLS) The successor protocol to SSL, created by the Internet Engineering Task Force (IETF) for general communication authentication and encryption over TCP/IP networks. TLS version 1 is nearly identical with SSL version 3.

See: SSL/TLS Encryption (p. 146)

Uniform Resource Locator (URL) The name/address of a resource on the Internet. This is the common informal term for what is formally called a Uniform Resource Identifier. URLs are usually made up of a scheme, like `http` or `https`, a hostname, and a path. A URL for this page is `http://httpd.apache.org/docs/2.0/glossary.html`.

Uniform Resource Identifier (URI) A compact string of characters for identifying an abstract or physical resource. It is formally defined by RFC 2396⁵. URIs used on the world-wide web are commonly referred to as URLs.

Virtual Hosting Serving multiple websites using a single instance of Apache. *IP virtual hosting* differentiates between websites based on their IP address, while *name-based virtual hosting* uses only the name of the host and can therefore host many sites on the same IP address.

See: Apache Virtual Host documentation (p. 110)

X.509 An authentication certificate scheme recommended by the International Telecommunication Union (ITU-T) which is used for SSL/TLS authentication.

See: SSL/TLS Encryption (p. 146)

⁴<http://www.pcre.org/>

⁵<http://www.ietf.org/rfc/rfc2396.txt>

12.2 Module Index

Below is a list of all of the modules that come as part of the Apache distribution. See also the complete alphabetical list of all Apache directives (p. 663).

See also

- Multi-Processing Modules (MPMs) (p. 59)
- Directive Quick Reference (p. 672)

Core Features and Multi-Processing Modules

core (p. 302) Core Apache HTTP Server features that are always available

mpm_common (p. 591) A collection of directives that are implemented by more than one multi-processing module (MPM)

beos (p. 589) This Multi-Processing Module is optimized for BeOS.

leader (p. 603) An experimental variant of the standard **WORKER** MPM

mpm_netware (p. 604) Multi-Processing Module implementing an exclusively threaded web server optimized for Novell NetWare

mpmt_os2 (p. 606) Hybrid multi-process, multi-threaded MPM for OS/2

perchild (p. 607) Multi-Processing Module allowing for daemon processes serving requests to be assigned a variety of different userids

prefork (p. 611) Implements a non-threaded, pre-forking web server

threadpool (p. 614) Yet another experimental variant of the standard **WORKER** MPM

mpm_winnt (p. 615) This Multi-Processing Module is optimized for Windows NT.

worker (p. 616) Multi-Processing Module implementing a hybrid multi-threaded multi-process web server

Other Modules

mod_access (p. 342) Provides access control based on client hostname, IP address, or other characteristics of the client request.

mod_actions (p. 346) This module provides for executing CGI scripts based on media type or request method.

mod_alias (p. 348) Provides for mapping different parts of the host filesystem in the document tree and for URL redirection

mod_asis (p. 353) Sends files that contain their own HTTP headers

mod_auth (p. 355) User authentication using text files

mod_auth_anon (p. 358) Allows "anonymous" user access to authenticated areas

mod_auth_dbm (p. 361) Provides for user authentication using DBM files

mod_auth_digest (p. 364) User authentication using MD5 Digest Authentication.

mod_auth_ldap (p. 369) Allows an LDAP directory to be used to store the database for HTTP Basic authentication.

- mod_autoindex** (p. 380) Generates directory indexes, automatically, similar to the Unix `ls` command or the Win32 `dir` shell command
- mod_cache** (p. 391) Content cache keyed to URIs.
- mod_cern_meta** (p. 397) CERN httpd metafile semantics
- mod_cgi** (p. 399) Execution of CGI scripts
- mod_cgid** (p. 402) Execution of CGI scripts using an external CGI daemon
- mod_charset_lite** (p. 403) Specify character set translation or recoding
- mod_dav** (p. 406) Distributed Authoring and Versioning (WebDAV⁶) functionality
- mod_dav_fs** (p. 410) filesystem provider for `MOD_DAV`
- mod_deflate** (p. 411) Compress content before it is delivered to the client
- mod_dir** (p. 416) Provides for "trailing slash" redirects and serving directory index files
- mod_disk_cache** (p. 418) Content cache storage manager keyed to URIs
- mod_dumpio** (p. 423) Dumps all I/O to error log as desired.
- mod_echo** (p. 425) A simple echo server to illustrate protocol modules
- mod_env** (p. 426) Modifies the environment which is passed to CGI scripts and SSI pages
- mod_example** (p. 428) Illustrates the Apache module API
- mod_expires** (p. 430) Generation of `Expires` and `Cache-Control` HTTP headers according to user-specified criteria
- mod_ext_filter** (p. 433) Pass the response body through an external program before delivery to the client
- mod_file_cache** (p. 439) Caches a static list of files in memory
- mod_headers** (p. 442) Customization of HTTP request and response headers
- mod_ldap** (p. 446) Server-side imagemap processing
- mod_include** (p. 450) Server-parsed html documents (Server Side Includes)
- mod_info** (p. 459) Provides a comprehensive overview of the server configuration
- mod_isapi** (p. 461) ISAPI Extensions within Apache for Windows
- mod_ldap** (p. 465) LDAP connection pooling and result caching services for use by other LDAP modules
- mod_log_config** (p. 471) Logging of the requests made to the server
- mod_log_forensic** (p. 476) Forensic Logging of the requests made to the server
- mod_logio** (p. 478) Logging of input and output bytes per request
- mod_mem_cache** (p. 479) Content cache keyed to URIs
- mod_mime** (p. 483) Associates the requested filename's extensions with the file's behavior (handlers and filters) and content (mime-type, language, character set and encoding)
- mod_mime_magic** (p. 495) Determines the MIME type of a file by looking at a few bytes of its contents

⁶<http://www.webdav.org/>

- mod_negotiation** (p. 499) Provides for content negotiation (p. 47)
- mod_nw_ssl** (p. 503) Enable SSL encryption for NetWare
- mod_proxy** (p. 504) HTTP/1.1 proxy/gateway server
- mod_proxy_connect** (p. 518) **MOD_PROXY** extension for **CONNECT** request handling
- mod_proxy_ftp** (p. 519) FTP support module for **MOD_PROXY**
- mod_proxy_http** (p. 520) HTTP support module for **MOD_PROXY**
- mod_rewrite** (p. 521) Provides a rule-based rewriting engine to rewrite requested URLs on the fly
- mod_setenvif** (p. 541) Allows the setting of environment variables based on characteristics of the request
- mod_so** (p. 545) Loading of executable code and modules into the server at start-up or restart time
- mod_speling** (p. 547) Attempts to correct mistaken URLs that users might have entered by ignoring capitalization and by allowing up to one misspelling
- mod_ssl** (p. 549) Strong cryptography using the Secure Sockets Layer (SSL) and Transport Layer Security (TLS) protocols
- mod_status** (p. 572) Provides information on server activity and performance
- mod_suexec** (p. 574) Allows CGI scripts to run as a specified user and Group
- mod_unique_id** (p. 575) Provides an environment variable with a unique identifier for each request
- mod_userdir** (p. 577) User-specific directories
- mod_usertrack** (p. 579) *Clickstream* logging of user activity on a site
- mod_version** (p. 583) Version dependent configuration
- mod_vhost_alias** (p. 585) Provides for dynamically configured mass virtual hosting

12.3 Directive Index

Each Apache directive available in the standard Apache distribution is listed here. They are described using a consistent format, and there is a dictionary (p. 299) of the terms used in their descriptions available.

A Directive Quick-Reference (p. 672) is also available giving details about each directive in a summary form.

- [AcceptMutex](#) (p. 591)
- [AcceptPathInfo](#) (p. 303)
- [AccessFileName](#) (p. 304)
- [Action](#) (p. 346)
- [AddAlt](#) (p. 382)
- [AddAltByEncoding](#) (p. 383)
- [AddAltByType](#) (p. 383)
- [AddCharset](#) (p. 485)
- [AddDefaultCharset](#) (p. 305)
- [AddDescription](#) (p. 383)
- [AddEncoding](#) (p. 486)
- [AddHandler](#) (p. 487)
- [AddIcon](#) (p. 384)
- [AddIconByEncoding](#) (p. 384)
- [AddIconByType](#) (p. 385)
- [AddInputFilter](#) (p. 487)
- [AddLanguage](#) (p. 487)
- [AddModuleInfo](#) (p. 459)
- [AddOutputFilter](#) (p. 488)
- [AddOutputFilterByType](#) (p. 305)
- [AddType](#) (p. 489)
- [Alias](#) (p. 349)
- [AliasMatch](#) (p. 349)
- [Allow](#) (p. 342)
- [AllowCONNECT](#) (p. 508)
- [AllowEncodedSlashes](#) (p. 306)
- [AllowOverride](#) (p. 307)
- [Anonymous](#) (p. 359)
- [Anonymous_Authoritative](#) (p. 359)
- [Anonymous_LogEmail](#) (p. 360)
- [Anonymous_MustGiveEmail](#) (p. 360)
- [Anonymous_NoUserID](#) (p. 360)
- [Anonymous_VerifyEmail](#) (p. 360)
- [AssignUserID](#) (p. 609)
- [AuthAuthoritative](#) (p. 355)

- AuthDBMAuthoritative (p. 361)
- AuthDBMGroupFile (p. 362)
- AuthDBMType (p. 362)
- AuthDBMUserFile (p. 363)
- AuthDigestAlgorithm (p. 365)
- AuthDigestDomain (p. 366)
- AuthDigestFile (p. 366)
- AuthDigestGroupFile (p. 366)
- AuthDigestNcCheck (p. 367)
- AuthDigestNonceFormat (p. 367)
- AuthDigestNonceLifetime (p. 367)
- AuthDigestQop (p. 368)
- AuthDigestShmemSize (p. 368)
- AuthGroupFile (p. 356)
- AuthLDAPAuthoritative (p. 375)
- AuthLDAPBindDN (p. 375)
- AuthLDAPBindPassword (p. 376)
- AuthLDAPCharsetConfig (p. 376)
- AuthLDAPCompareDNOnServer (p. 376)
- AuthLDAPDereferenceAliases (p. 377)
- AuthLDAPEnabled (p. 377)
- AuthLDAPFrontPageHack (p. 377)
- AuthLDAPGroupAttribute (p. 377)
- AuthLDAPGroupAttributeIsDN (p. 378)
- AuthLDAPRemoteUserIsDN (p. 378)
- AuthLDAPUrl (p. 378)
- AuthName (p. 308)
- AuthType (p. 308)
- AuthUserFile (p. 356)
- BrowserMatch (p. 541)
- BrowserMatchNoCase (p. 542)
- BS2000Account (p. 592)
- BufferedLogs (p. 473)
- CacheDefaultExpire (p. 393)
- CacheDirLength (p. 418)
- CacheDirLevels (p. 419)
- CacheDisable (p. 393)
- CacheEnable (p. 393)
- CacheExpiryCheck (p. 419)
- CacheFile (p. 440)
- CacheForceCompletion (p. 394)

- [CacheGcClean](#) (p. 419)
- [CacheGcDaily](#) (p. 420)
- [CacheGcInterval](#) (p. 420)
- [CacheGcMemUsage](#) (p. 420)
- [CacheGcUnused](#) (p. 421)
- [CacheIgnoreCacheControl](#) (p. 394)
- [CacheIgnoreHeaders](#) (p. 394)
- [CacheIgnoreNoLastMod](#) (p. 395)
- [CacheLastModifiedFactor](#) (p. 396)
- [CacheMaxExpire](#) (p. 396)
- [CacheMaxFileSize](#) (p. 421)
- [CacheMinFileSize](#) (p. 421)
- [CacheNegotiatedDocs](#) (p. 500)
- [CacheRoot](#) (p. 421)
- [CacheSize](#) (p. 422)
- [CacheTimeMargin](#) (p. 422)
- [CGIMapExtension](#) (p. 308)
- [CharsetDefault](#) (p. 404)
- [CharsetOptions](#) (p. 404)
- [CharsetSourceEnc](#) (p. 404)
- [CheckSpelling](#) (p. 547)
- [ChildPerUserID](#) (p. 609)
- [ContentDigest](#) (p. 309)
- [CookieDomain](#) (p. 580)
- [CookieExpires](#) (p. 580)
- [CookieLog](#) (p. 473)
- [CookieName](#) (p. 581)
- [CookieStyle](#) (p. 581)
- [CookieTracking](#) (p. 581)
- [CoreDumpDirectory](#) (p. 592)
- [CustomLog](#) (p. 474)
- [Dav](#) (p. 408)
- [DavDepthInfinity](#) (p. 408)
- [DavLockDB](#) (p. 410)
- [DavMinTimeout](#) (p. 408)
- [DefaultIcon](#) (p. 385)
- [DefaultLanguage](#) (p. 489)
- [DefaultType](#) (p. 309)
- [DeflateBufferSize](#) (p. 414)
- [DeflateCompressionLevel](#) (p. 414)
- [DeflateFilterNote](#) (p. 414)

- DeflateMemLevel (p. 415)
- DeflateWindowSize (p. 415)
- Deny (p. 344)
- Directory (p. 310)
- DirectoryIndex (p. 416)
- DirectoryMatch (p. 311)
- DirectorySlash (p. 417)
- DocumentRoot (p. 312)
- DumpIOInput (p. 423)
- DumpIOOutput (p. 423)
- EnableExceptionHook (p. 593)
- EnableMMAP (p. 312)
- EnableSendfile (p. 313)
- ErrorDocument (p. 313)
- ErrorLog (p. 315)
- Example (p. 429)
- ExpiresActive (p. 431)
- ExpiresByType (p. 431)
- ExpiresDefault (p. 432)
- ExtendedStatus (p. 573)
- ExtFilterDefine (p. 436)
- ExtFilterOptions (p. 437)
- FileETag (p. 315)
- Files (p. 316)
- FilesMatch (p. 317)
- ForceLanguagePriority (p. 501)
- ForceType (p. 317)
- ForensicLog (p. 477)
- Group (p. 593)
- Header (p. 443)
- HeaderName (p. 385)
- HostnameLookups (p. 318)
- IdentityCheck (p. 318)
- IfDefine (p. 318)
- IfModule (p. 319)
- IfVersion (p. 583)
- ImapBase (p. 448)
- ImapDefault (p. 449)
- ImapMenu (p. 449)
- Include (p. 320)
- IndexIgnore (p. 386)

- [IndexOptions](#) (p. 386)
- [IndexOrderDefault](#) (p. 389)
- [ISAPIAppendLogToErrors](#) (p. 463)
- [ISAPIAppendLogToQuery](#) (p. 463)
- [ISAPICacheFile](#) (p. 463)
- [ISAPIFakeAsync](#) (p. 464)
- [ISAPILogNotSupported](#) (p. 464)
- [ISAPIReadAheadBuffer](#) (p. 464)
- [KeepAlive](#) (p. 320)
- [KeepAliveTimeout](#) (p. 321)
- [LanguagePriority](#) (p. 502)
- [LDAPCacheEntries](#) (p. 468)
- [LDAPCacheTTL](#) (p. 468)
- [LDAPConnectionTimeout](#) (p. 468)
- [LDAPOpCacheEntries](#) (p. 468)
- [LDAPOpCacheTTL](#) (p. 469)
- [LDAPSharedCacheFile](#) (p. 469)
- [LDAPSharedCacheSize](#) (p. 469)
- [LDAPTrustedCA](#) (p. 469)
- [LDAPTrustedCAType](#) (p. 469)
- [Limit](#) (p. 321)
- [LimitExcept](#) (p. 322)
- [LimitInternalRecursion](#) (p. 322)
- [LimitRequestBody](#) (p. 322)
- [LimitRequestFields](#) (p. 323)
- [LimitRequestFieldSize](#) (p. 323)
- [LimitRequestLine](#) (p. 324)
- [LimitXMLRequestBody](#) (p. 324)
- [Listen](#) (p. 594)
- [ListenBackLog](#) (p. 594)
- [LoadFile](#) (p. 546)
- [LoadModule](#) (p. 546)
- [Location](#) (p. 325)
- [LocationMatch](#) (p. 326)
- [LockFile](#) (p. 595)
- [LogFormat](#) (p. 475)
- [LogLevel](#) (p. 326)
- [MaxClients](#) (p. 595)
- [MaxKeepAliveRequests](#) (p. 327)
- [MaxMemFree](#) (p. 596)
- [MaxRequestsPerChild](#) (p. 596)

- `MaxRequestsPerThread` (p. 589)
- `MaxSpareServers` (p. 612)
- `MaxSpareThreads` (p. 596)
- `MaxThreads` (p. 605)
- `MaxThreadsPerChild` (p. 610)
- `MCacheMaxObjectCount` (p. 479)
- `MCacheMaxObjectSize` (p. 480)
- `MCacheMaxStreamingBuffer` (p. 480)
- `MCacheMinObjectSize` (p. 481)
- `MCacheRemovalAlgorithm` (p. 481)
- `MCacheSize` (p. 481)
- `MetaDir` (p. 397)
- `MetaFiles` (p. 398)
- `MetaSuffix` (p. 398)
- `MimeMagicFile` (p. 498)
- `MinSpareServers` (p. 612)
- `MinSpareThreads` (p. 597)
- `MMapFile` (p. 440)
- `ModMimeUsePathInfo` (p. 490)
- `MultiviewsMatch` (p. 490)
- `NameVirtualHost` (p. 327)
- `NoProxy` (p. 508)
- `NumServers` (p. 610)
- `NWSSLTrustedCerts` (p. 503)
- `NWSSLUpgradeable` (p. 503)
- `Options` (p. 328)
- `Order` (p. 344)
- `PassEnv` (p. 426)
- `PidFile` (p. 598)
- `ProtocolEcho` (p. 425)
- `Proxy` (p. 510)
- `ProxyBadHeader` (p. 510)
- `ProxyBlock` (p. 511)
- `ProxyDomain` (p. 511)
- `ProxyErrorOverride` (p. 512)
- `ProxyFtpDirCharset` (p. 512)
- `ProxyIOBufferSize` (p. 512)
- `ProxyMatch` (p. 512)
- `ProxyMaxForwards` (p. 513)
- `ProxyPass` (p. 513)
- `ProxyPassReverse` (p. 514)

- ProxyPreserveHost (p. 514)
- ProxyReceiveBufferSize (p. 515)
- ProxyRemote (p. 515)
- ProxyRemoteMatch (p. 515)
- ProxyRequests (p. 516)
- ProxyTimeout (p. 516)
- ProxyVia (p. 516)
- ReadmeName (p. 390)
- ReceiveBufferSize (p. 598)
- Redirect (p. 350)
- RedirectMatch (p. 351)
- RedirectPermanent (p. 351)
- RedirectTemp (p. 351)
- RemoveCharset (p. 491)
- RemoveEncoding (p. 491)
- RemoveHandler (p. 492)
- RemoveInputFilter (p. 492)
- RemoveLanguage (p. 493)
- RemoveOutputFilter (p. 493)
- RemoveType (p. 493)
- RequestHeader (p. 444)
- Require (p. 330)
- RewriteBase (p. 523)
- RewriteCond (p. 525)
- RewriteEngine (p. 528)
- RewriteLock (p. 529)
- RewriteLog (p. 529)
- RewriteLogLevel (p. 530)
- RewriteMap (p. 530)
- RewriteOptions (p. 533)
- RewriteRule (p. 534)
- RLimitCPU (p. 330)
- RLimitMEM (p. 331)
- RLimitNPROC (p. 331)
- Satisfy (p. 332)
- ScoreBoardFile (p. 598)
- Script (p. 347)
- ScriptAlias (p. 351)
- ScriptAliasMatch (p. 352)
- ScriptInterpreterSource (p. 333)
- ScriptLog (p. 400)

- ScriptLogBuffer (p. 401)
- ScriptLogLength (p. 401)
- ScriptSock (p. 402)
- SecureListen (p. 503)
- SendBufferSize (p. 599)
- ServerAdmin (p. 333)
- ServerAlias (p. 334)
- ServerLimit (p. 599)
- ServerName (p. 334)
- ServerPath (p. 335)
- ServerRoot (p. 335)
- ServerSignature (p. 335)
- ServerTokens (p. 336)
- SetEnv (p. 426)
- SetEnvIf (p. 542)
- SetEnvIfNoCase (p. 544)
- SetHandler (p. 336)
- SetInputFilter (p. 337)
- SetOutputFilter (p. 337)
- SSIEndTag (p. 456)
- SSIErrorMsg (p. 456)
- SSIStartTag (p. 457)
- SSITimeFormat (p. 457)
- SSIUndefinedEcho (p. 458)
- SSLCACertificateFile (p. 551)
- SSLCACertificatePath (p. 551)
- SSLCARevocationFile (p. 552)
- SSLCARevocationPath (p. 552)
- SSLCertificateChainFile (p. 552)
- SSLCertificateFile (p. 553)
- SSLCertificateKeyFile (p. 553)
- SSLCipherSuite (p. 554)
- SSLEngine (p. 556)
- SSLMutex (p. 557)
- SSLOptions (p. 558)
- SSLPassPhraseDialog (p. 559)
- SSLProtocol (p. 560)
- SSLProxyCACertificateFile (p. 561)
- SSLProxyCACertificatePath (p. 561)
- SSLProxyCARevocationFile (p. 561)
- SSLProxyCARevocationPath (p. 562)

- [SSLProxyCipherSuite](#) (p. 562)
- [SSLProxyEngine](#) (p. 562)
- [SSLProxyMachineCertificateFile](#) (p. 563)
- [SSLProxyMachineCertificatePath](#) (p. 563)
- [SSLProxyProtocol](#) (p. 563)
- [SSLProxyVerify](#) (p. 564)
- [SSLProxyVerifyDepth](#) (p. 564)
- [SSLRandomSeed](#) (p. 565)
- [SSLRequire](#) (p. 566)
- [SSLRequireSSL](#) (p. 568)
- [SSLSessionCache](#) (p. 569)
- [SSLSessionCacheTimeout](#) (p. 569)
- [SSLUserName](#) (p. 570)
- [SSLVerifyClient](#) (p. 570)
- [SSLVerifyDepth](#) (p. 571)
- [StartServers](#) (p. 600)
- [StartThreads](#) (p. 600)
- [SuexecUserGroup](#) (p. 574)
- [ThreadLimit](#) (p. 600)
- [ThreadsPerChild](#) (p. 601)
- [ThreadStackSize](#) (p. 605)
- [TimeOut](#) (p. 338)
- [TraceEnable](#) (p. 338)
- [TransferLog](#) (p. 475)
- [TypesConfig](#) (p. 494)
- [UnsetEnv](#) (p. 427)
- [UseCanonicalName](#) (p. 339)
- [User](#) (p. 601)
- [UserDir](#) (p. 577)
- [VirtualDocumentRoot](#) (p. 587)
- [VirtualDocumentRootIP](#) (p. 587)
- [VirtualHost](#) (p. 339)
- [VirtualScriptAlias](#) (p. 587)
- [VirtualScriptAliasIP](#) (p. 588)
- [Win32DisableAcceptEx](#) (p. 615)
- [XBitHack](#) (p. 458)

12.4 Directive Quick Reference

The directive quick reference shows the usage, default, status, and context of each Apache configuration directive. For more information about each of these, see the Directive Dictionary (p. 299) .

The first column gives the directive name and usage. The second columns shows the default value of the directive, if a default exists. If the default is too large to display, the first characters will be followed by "+".

The third and fourth columns list the contexts where the directive is allowed and the status of the directive according to the legend tables below.

s	serverconfig
v	virtualhost
d	directory
h	.htaccess

C	Core
M	MPM
B	Base
E	Extension
X	Experimental

AcceptMutex Default method Method that Apache uses to serialize multiple children accepting requests on network sockets	Default	s	M
AcceptPathInfo On Off Default Resources accept trailing pathname information	Default	svdh	C
AccessFileName filename [filename] ... Name of the distributed configuration file	.htaccess	sv	C
Action action-type cgi-script Activates a CGI script for a particular handler or content-type		svdh	B
AddAlt string file [file] ... Alternate text to display for a file, instead of an icon selected by filename		svdh	B
AddAltByEncoding string MIME-encoding [MIME-encoding] ... Alternate text to display for a file instead of an icon selected by MIME-encoding		svdh	B
AddAltByType string MIME-type [MIME-type] ... Alternate text to display for a file, instead of an icon selected by MIME content-type		svdh	B
AddCharset charset extension [extension] ... Maps the given filename extensions to the specified content charset		svdh	B
AddDefaultCharset On Off charset Default charset parameter to be added when a response content-type is text/plain or text/html	Off	svdh	C
AddDescription string file [file] ... Description to display for a file		svdh	B
AddEncoding MIME-enc extension [extension] ... Maps the given filename extensions to the specified encoding type		svdh	B
AddHandler handler-name extension [extension] ... Maps the filename extensions to the specified handler		svdh	B
AddIcon icon name [name] ... Icon to display for a file selected by name		svdh	B
AddIconByEncoding icon MIME-encoding [MIME-encoding] ... Icon to display next to files selected by MIME content-encoding		svdh	B
AddIconByType icon MIME-type [MIME-type] ... Icon to display next to files selected by MIME content-type		svdh	B
AddInputFilter filter[;filter...] extension [extension] ... Maps filename extensions to the filters that will process client requests			B
AddLanguage MIME-lang extension [extension] ... Maps the given filename extension to the specified content language		svdh	B
AddModuleInfo module-name string Adds additional information to the module information displayed by the server-info handler		sv	E
AddOutputFilter filter[;filter...] extension [extension] ... Maps filename extensions to the filters that will process responses from the server		svdh	B

AddOutputFilterByType filter[;filter...] MIME-type [MIME-type] ... assigns an output filter to a particular MIME-type		svdh	C	p. 305
AddType MIME-type extension [extension] ... Maps the given filename extensions onto the specified content type		svdh	B	p. 489
Alias URL-path file-path directory-path Maps URLs to filesystem locations		sv	B	p. 349
AliasMatch regex file-path directory-path Maps URLs to filesystem locations using regular expressions		sv	B	p. 349
Allow from all host env=env-variable [host env=env-variable] ... Controls which hosts can access an area of the server		dh	B	p. 342
AllowCONNECT port [port] ... Ports that are allowed to CONNECT through the proxy	443 563	sv	E	p. 508
AllowEncodedSlashes On Off Determines whether encoded path separators in URLs are allowed to be passed through	Off	sv	C	p. 306
AllowOverride All None directive-type [directive-type] ... Types of directives that are allowed in .htaccess files	All	d	C	p. 307
Anonymous user [user] ... Specifies userIDs that are allowed access without password verification		dh	E	p. 359
AnonymousAuthoritative On Off Configures if authorization will fall-through to other methods	Off	dh	E	p. 359
AnonymousLogEmail On Off Sets whether the password entered will be logged in the error log	On	dh	E	p. 360
AnonymousMustGiveEmail On Off Specifies whether blank passwords are allowed	On	dh	E	p. 360
AnonymousNoUserID On Off Sets whether the userID field may be empty	Off	dh	E	p. 360
AnonymousVerifyEmail On Off Sets whether to check the password field for a correctly formatted email address	Off	dh	E	p. 360
AssignUserID user-id group-id Tie a virtual host to a user and group ID		v	M	p. 609
AuthAuthoritative On Off Sets whether authorization and authentication are passed to lower level modules	On	dh	B	p. 355
AuthDBMAuthoritative On Off Sets whether authentication and authorization will be passed on to lower level modules	On	dh	E	p. 361
AuthDBMGroupFile file-path Sets the name of the database file containing the list of user groups for authentication		dh	E	p. 362
AuthDBMType default SDBM GDBM NDBM DB Sets the type of database file that is used to store passwords	default	dh	E	p. 362
AuthDBMUserFile file-path Sets the name of a database file containing the list of users and passwords for authentication		dh	E	p. 363
AuthDigestAlgorithm MD5 MD5-sess Selects the algorithm used to calculate the challenge and response hashes in digest authentication	MD5	dh	X	p. 365
AuthDigestDomain URI [URI] ... URIs that are in the same protection space for digest authentication		dh	X	p. 366
AuthDigestFile file-path Location of the text file containing the list of users and encoded passwords for digest authentication		dh	X	p. 366
AuthDigestGroupFile file-path Name of the text file containing the list of groups for digest authentication		dh	X	p. 366
AuthDigestNcCheck On Off Enables or disables checking of the nonce-count sent by the server	Off	s	X	p. 367
AuthDigestNonceFormat format Determines how the nonce is generated		dh	X	p. 367
AuthDigestNonceLifetime seconds How long the server nonce is valid	300	dh	X	p. 367
AuthDigestQop none auth auth-int [auth auth-int] Determines the quality-of-protection to use in digest authentication	auth	dh	X	p. 368
AuthDigestShmemSize size The amount of shared memory to allocate for keeping track of clients	1000	s	X	p. 368
AuthGroupFile file-path Sets the name of a text file containing the list of user groups for authentication		dh	B	p. 356
AuthLDAPAuthoritative on off Prevent other authentication modules from authenticating the user if this one fails	on	dh	X	p. 375

AuthLDAPBindDN <i>distinguished-name</i> Optional DN to use in binding to the LDAP server		dh	X
		p. 375	
AuthLDAPBindPassword <i>password</i> Password used in conjunction with the bind DN		dh	X
		p. 376	
AuthLDAPCharsetConfig <i>file-path</i> Language to charset conversion configuration file		s	X
		p. 376	
AuthLDAPCompareDNOnServer on off Use the LDAP server to compare the DNs	on	dh	X
		p. 376	
AuthLDAPDereferenceAliases never searching finding always When will the module de-reference aliases	Always	dh	X
		p. 377	
AuthLDAPEnabled on off Turn on or off LDAP authentication	on	dh	X
		p. 377	
AuthLDAPFrontPageHack on off Allow LDAP authentication to work with MS FrontPage	off	dh	X
		p. 377	
AuthLDAPGroupAttribute <i>attribute</i> LDAP attributes used to check for group membership		dh	X
		p. 377	
AuthLDAPGroupAttributeIsDN on off Use the DN of the client username when checking for group membership	on	dh	X
		p. 378	
AuthLDAPRemoteUserIsDN on off Use the DN of the client username to set the REMOTE_USER environment variable	off	dh	X
		p. 378	
AuthLDAPUrl <i>url</i> URL specifying the LDAP search parameters		dh	X
		p. 378	
AuthName <i>auth-domain</i> Authorization realm for use in HTTP authentication		dh	C
		p. 308	
AuthType Basic Digest Type of user authentication		dh	C
		p. 308	
AuthUserFile <i>file-path</i> Sets the name of a text file containing the list of users and passwords for authentication		dh	B
		p. 356	
BrowserMatch <i>regex</i> [!]env-variable[=value] [[!]env-variable[=value]] ... Sets environment variables conditional on HTTP User-Agent		svdh	B
		p. 541	
BrowserMatchNoCase <i>regex</i> [!]env-variable[=value] [[!]env-variable[=value]] ... Sets environment variables conditional on User-Agent without respect to case		svdh	B
		p. 542	
BS2000Account <i>account</i> Define the non-privileged account on BS2000 machines		s	M
		p. 592	
BufferedLogs On Off Buffer log entries in memory before writing to disk	Off	s	B
		p. 473	
CacheDefaultExpire seconds The default duration to cache a document when no expiry date is specified.	3600 (one hour)	sv	X
		p. 393	
CacheDirLength <i>length</i> The number of characters in subdirectory names	2	sv	X
		p. 418	
CacheDirLevels <i>levels</i> The number of levels of subdirectories in the cache.	3	sv	X
		p. 419	
CacheDisable <i>url-string</i> Disable caching of specified URLs		sv	X
		p. 393	
CacheEnable <i>cache.type url-string</i> Enable caching of specified URLs using a specified storage manager		sv	X
		p. 393	
CacheExpiryCheck On Off Indicates if the cache observes Expires dates when seeking files	On	sv	X
		p. 419	
CacheFile <i>file-path</i> [<i>file-path</i>] ... Cache a list of file handles at startup time		s	X
		p. 440	
CacheForceCompletion Percentage Percentage of document served, after which the server will complete caching the file even if the request is cancelled.	60	sv	X
		p. 394	
CacheGcClean hours <i>url-string</i> The time to retain unchanged cached files that match a URL	?	sv	X
		p. 419	
CacheGcDaily time The recurring time each day for garbage collection to be run. (24 hour clock)	?	sv	X
		p. 420	
CacheGcInterval hours The interval between garbage collection attempts.		sv	X
		p. 420	
CacheGcMemUsage KBytes The maximum kilobytes of memory used for garbage collection	?	sv	X
		p. 420	
CacheGcUnused hours <i>url-string</i> The time to retain unreferenced cached files that match a URL.	?	sv	X
		p. 421	

CacheIgnoreCacheControl On Off	Off	sv	X
Ignore the fact that the client requested the content not be cached.			p. 394
CacheIgnoreHeaders header-string [header-string] ...	None	sv	X
Do not store the given HTTP header(s) in the cache.			p. 394
CacheIgnoreNoLastMod On Off	Off	sv	X
Ignore the fact that a response has no Last Modified header.			p. 395
CacheLastModifiedFactor float	0.1	sv	X
The factor used to compute an expiry date based on the LastModified date.			p. 396
CacheMaxExpire seconds	86400 (one day)	sv	X
The maximum time in seconds to cache a document			p. 396
CacheMaxFileSize bytes	1000000	sv	X
The maximum size (in bytes) of a document to be placed in the cache			p. 421
CacheMinFileSize bytes	1	sv	X
The minimum size (in bytes) of a document to be placed in the cache			p. 421
CacheNegotiatedDocs On Off	Off	sv	B
Allows content-negotiated documents to be cached by proxy servers			p. 500
CacheRoot directory		sv	X
The directory root under which cache files are stored			p. 421
CacheSize KBytes	1000000	sv	X
The maximum amount of disk space that will be used by the cache in KBytes			p. 422
CacheTimeMargin ?	?	sv	X
The minimum time margin to cache a document			p. 422
CGIMapExtension cgi-path .extension		dh	C
Technique for locating the interpreter for CGI scripts			p. 308
CharsetDefault charset		svdh	X
Charset to translate into			p. 404
CharsetOptions option [option] ...	DebugLevel=0 NoImpl +	svdh	X
Configures charset translation behavior			p. 404
CharsetSourceEnc charset		svdh	X
Source charset of files			p. 404
CheckSpelling on off	Off	svdh	E
Enables the spelling module			p. 547
ChildPerUserID user-id group-id num-children		s	M
Specify user ID and group ID for a number of child processes			p. 609
ContentDigest On Off	Off	svdh	C
Enables the generation of Content-MD5 HTTP Response headers			p. 309
CookieDomain domain		svdh	E
The domain to which the tracking cookie applies			p. 580
CookieExpires expiry-period		svdh	E
Expiry time for the tracking cookie			p. 580
CookieLog filename		sv	B
Sets filename for the logging of cookies			p. 473
CookieName token	Apache	svdh	E
Name of the tracking cookie			p. 581
CookieStyle Netscape Cookie Cookie2 RFC2109 RFC2965	Netscape	svdh	E
Format of the cookie header field			p. 581
CookieTracking on off	off	svdh	E
Enables tracking cookie			p. 581
CoreDumpDirectory directory		s	M
Directory where Apache attempts to switch before dumping core			p. 592
CustomLog file pipe format nickname [env=[!]environment-variable]		sv	B
Sets filename and format of log file			p. 474
Dav On Off provider-name	Off	d	E
Enable WebDAV HTTP methods			p. 408
DavDepthInfinity on off	off	svd	E
Allow PROPFIND, Depth: Infinity requests			p. 408
DavLockDB file-path		sv	E
Location of the DAV lock database			p. 410
DavMinTimeout seconds	0	svd	E
Minimum amount of time the server holds a lock on a DAV resource			p. 408
DefaultIcon url-path		svdh	B
Icon to display for files when no specific icon is configured			p. 385
DefaultLanguage MIME-lang		svdh	B
Sets all files in the given scope to the specified language			p. 489

DefaultType MIME-type	text/plain	svdh	C
MIME content-type that will be sent if the server cannot determine a type in any other way		p.	309
DeflateBufferSize value	8096	sv	E
Fragment size to be compressed at one time by zlib		p.	414
DeflateCompressionLevel value		sv	E
How much compression do we apply to the output		p.	414
DeflateFilterNote [type] notename		sv	E
Places the compression ratio in a note for logging		p.	414
DeflateMemLevel value	9	sv	E
How much memory should be used by zlib for compression		p.	415
DeflateWindowSize value	15	sv	E
Zlib compression window size		p.	415
Deny from all host env=env-variable [host env=env-variable]		dh	B
...			
Controls which hosts are denied access to the server		p.	344
<Directory directory-path> ... </Directory>		sv	C
Enclose a group of directives that apply only to the named file-system directory and sub-directories		p.	310
DirectoryIndex local-url [local-url] ...	index.html	svdh	B
List of resources to look for when the client requests a directory		p.	416
<DirectoryMatch regex> ... </DirectoryMatch>		sv	C
Enclose directives that apply to file-system directories matching a regular expression and their subdirectories		p.	311
DirectorySlash On Off	On	svdh	B
Toggle trailing slash redirects on or off		p.	417
DocumentRoot directory-path	/usr/local/apache/h +	sv	C
Directory that forms the main document tree visible from the web		p.	312
DumpIOInput On Off	Off	s	X
Dump all input data to the error log		p.	423
DumpIOOutput On Off	Off	s	X
Dump all output data to the error log		p.	423
EnableExceptionHook On Off	Off	s	M
Enables a hook that runs exception handlers after a crash		p.	593
EnableMMAP On Off	On	svdh	C
Use memory-mapping to read files during delivery		p.	312
EnableSendfile On Off	On	svdh	C
Use the kernel sendfile support to deliver files to the client		p.	313
ErrorDocument error-code document		svdh	C
What the server will return to the client in case of an error		p.	313
ErrorLog file-path syslog[:facility]	logs/error.log (Uni +	sv	C
Location where the server will log errors		p.	315
Example		svdh	X
Demonstration directive to illustrate the Apache module API		p.	429
ExpiresActive On Off		svdh	E
Enables generation of Expires headers		p.	431
ExpiresByType MIME-type <code>seconds		svdh	E
Value of the Expires header configured by MIME type		p.	431
ExpiresDefault <code>seconds		svdh	E
Default algorithm for calculating expiration time		p.	432
ExtendedStatus On Off	Off	s	B
Keep track of extended status information for each request		p.	573
ExtFilterDefine filtername parameters		s	E
Define an external filter		p.	436
ExtFilterOptions option [option] ...	DebugLevel=0 NoLogS +	d	E
Configure MOD_EXT_FILTER options		p.	437
FileETag component ...	INode MTime Size	svdh	C
File attributes used to create the ETag HTTP response header		p.	315
<Files filename> ... </Files>		svdh	C
Contains directives that apply to matched filenames		p.	316
<FilesMatch regex> ... </FilesMatch>		svdh	C
Contains directives that apply to regular-expression matched filenames		p.	317
ForceLanguagePriority None Prefer Fallback [Prefer Fallback]	Prefer	svdh	B
Action to take if a single acceptable document is not found		p.	501
ForceType MIME-type None		dh	C
Forces all matching files to be served with the specified MIME content-type		p.	317

ForensicLog filename pipe		sv	E
Sets filename of the forensic log		p. 477	
Group unix-group	#-1	s	M
Group under which the server will answer requests		p. 593	
Header [condition] set append add unset echo header [value] [env=[!]variable]		svdh	E
Configure HTTP response headers		p. 443	
HeaderName filename		svdh	B
Name of the file that will be inserted at the top of the index listing		p. 385	
HostnameLookups On Off Double	Off	svd	C
Enables DNS lookups on client IP addresses		p. 318	
IdentityCheck On Off	Off	svd	C
Enables logging of the RFC1413 identity of the remote user		p. 318	
<IfDefine [!]parameter-name> ... </IfDefine>		svdh	C
Encloses directives that will be processed only if a test is true at startup		p. 318	
<IfModule [!]module-name> ... </IfModule>		svdh	C
Encloses directives that are processed conditional on the presence or absence of a specific module		p. 319	
<IfVersion [!]operator version> ... </IfVersion>		svdh	E
contains version dependent configuration		p. 583	
ImapBase map referer URL	http://servername/	svdh	B
Default base for imagemap files		p. 448	
ImapDefault error nocontent map referer URL	nocontent	svdh	B
Default action when an imagemap is called with coordinates that are not explicitly mapped		p. 449	
ImapMenu none formatted semiformatted unformatted		svdh	B
Action if no coordinates are given when calling an imagemap		p. 449	
Include file-path directory-path		svd	C
Includes other configuration files from within the server configuration files		p. 320	
IndexIgnore file [file] ...		svdh	B
Adds to the list of files to hide when listing a directory		p. 386	
IndexOptions [+ -]option [+ -]option ...		svdh	B
Various configuration settings for directory indexing		p. 386	
IndexOrderDefault Ascending Descending Name Date Size Description	Ascending Name	svdh	B
Sets the default ordering of the directory index		p. 389	
ISAPIAppendLogToErrors on off	off	svdh	B
Record HSE_APPEND.LOG.PARAMETER requests from ISAPI extensions to the error log		p. 463	
ISAPIAppendLogToQuery on off	on	svdh	B
Record HSE_APPEND.LOG.PARAMETER requests from ISAPI extensions to the query field		p. 463	
ISAPICacheFile file-path [file-path] ...		sv	B
ISAPI .dll files to be loaded at startup		p. 463	
ISAPIFakeAsync on off	off	svdh	B
Fake asynchronous support for ISAPI callbacks		p. 464	
ISAPILogNotSupported on off	off	svdh	B
Log unsupported feature requests from ISAPI extensions		p. 464	
ISAPIReadAheadBuffer size	49152	svdh	B
Size of the Read Ahead Buffer sent to ISAPI extensions		p. 464	
KeepAlive On Off	On	sv	C
Enables HTTP persistent connections		p. 320	
KeepAliveTimeout seconds	15	sv	C
Amount of time the server will wait for subsequent requests on a persistent connection		p. 321	
LanguagePriority MIME-lang [MIME-lang] ...		svdh	B
The precedence of language variants for cases where the client does not express a preference		p. 502	
LDAPCacheEntries number	1024	s	X
Maximum number of entries in the primary LDAP cache		p. 468	
LDAPCacheTTL seconds	600	s	X
Time that cached items remain valid		p. 468	
LDAPConnectionTimeout seconds		s	X
Specifies the socket connection timeout in seconds		p. 468	
LDAPOpCacheEntries number	1024	s	X
Number of entries used to cache LDAP compare operations		p. 468	
LDAPOpCacheTTL seconds	600	s	X
Time that entries in the operation cache remain valid		p. 469	
LDAPSharedCacheFile directory-path/filename		s	X
Sets the shared memory cache file		p. 469	

LDAPSharedCacheSize bytes	102400	s	X
Size in bytes of the shared-memory cache			p. 469
LDAPTrustedCA directory-path/filename		s	X
Sets the file containing the trusted Certificate Authority certificate or database			p. 469
LDAPTrustedCAType type		s	X
Specifies the type of the Certificate Authority file			p. 469
<Limit method [method] ... > ... </Limit>		svdh	C
Restrict enclosed access controls to only certain HTTP methods			p. 321
<LimitExcept method [method] ... > ... </LimitExcept>		svdh	C
Restrict access controls to all HTTP methods except the named ones			p. 322
LimitInternalRecursion number [number]	10	sv	C
Determine maximum number of internal redirects and nested subrequests			p. 322
LimitRequestBody bytes	0	svdh	C
Restricts the total size of the HTTP request body sent from the client			p. 322
LimitRequestFields number	100	s	C
Limits the number of HTTP request header fields that will be accepted from the client			p. 323
LimitRequestFieldsize bytes		s	C
Limits the size of the HTTP request header allowed from the client			p. 323
LimitRequestLine bytes	8190	s	C
Limit the size of the HTTP request line that will be accepted from the client			p. 324
LimitXMLRequestBody bytes	1000000	svdh	C
Limits the size of an XML-based request body			p. 324
Listen [IP-address:]portnumber		s	M
IP addresses and ports that the server listens to			p. 594
ListenBacklog backlog		s	M
Maximum length of the queue of pending connections			p. 594
LoadFile filename [filename] ...		s	E
Link in the named object file or library			p. 546
LoadModule module filename		s	E
Links in the object file or library, and adds to the list of active modules			p. 546
<Location URL-path URL> ... </Location>		sv	C
Applies the enclosed directives only to matching URLs			p. 325
<LocationMatch regex> ... </LocationMatch>		sv	C
Applies the enclosed directives only to regular-expression matching URLs			p. 326
LockFile filename	logs/accept.lock	s	M
Location of the accept serialization lock file			p. 595
LogFormat format nickname [nickname]	"%h %l %u %t \"%r\" +	sv	B
Describes a format for use in a log file			p. 475
LogLevel level	warn	sv	C
Controls the verbosity of the ErrorLog			p. 326
MaxClients number		s	M
Maximum number of child processes that will be created to serve requests			p. 595
MaxKeepAliveRequests number	100	sv	C
Number of requests allowed on a persistent connection			p. 327
MaxMemFree KBytes	0	s	M
Maximum amount of memory that the main allocator is allowed to hold without calling free()			p. 596
MaxRequestsPerChild number	10000	s	M
Limit on the number of requests that an individual child server will handle during its life			p. 596
MaxRequestsPerThread number	0	s	M
Limit on the number of requests that an individual thread will handle during its life			p. 589
MaxSpareServers number	10	s	M
Maximum number of idle child server processes			p. 612
MaxSpareThreads number		s	M
Maximum number of idle threads			p. 596
MaxThreads number	2048	s	M
Set the maximum number of worker threads			p. 605
MaxThreadsPerChild number	64	s	M
Maximum number of threads per child process			p. 610
MCacheMaxObjectCount value	1009	s	X
The maximum number of objects allowed to be placed in the cache			p. 479
MCacheMaxObjectSize bytes	10000	s	X
The maximum size (in bytes) of a document allowed in the cache			p. 480
MCacheMaxStreamingBuffer size.in.bytes	the smaller of 1000 +	s	X
Maximum amount of a streamed response to buffer in memory before declaring the response uncacheable			p. 480

MCacheMinObjectSize bytes The minimum size (in bytes) of a document to be allowed in the cache	0	s	X
MCacheRemovalAlgorithm LRU GDSF The algorithm used to select documents for removal from the cache	GDSF	s	X
MCacheSize KBytes The maximum amount of memory used by the cache in KBytes	100	s	X
MetaDir directory Name of the directory to find CERN-style meta information files	.web	svdh	E
MetaFiles on off Activates CERN meta-file processing	off	svdh	E
MetaSuffix suffix File name suffix for the file containing CERN-style meta information	.meta	svdh	E
MimeMagicFile file-path Enable MIME-type determination based on file contents using the specified magic file		sv	E
MinSpareServers number Minimum number of idle child server processes	5	s	M
MinSpareThreads number Minimum number of idle threads available to handle request spikes		s	M
MMapFile file-path [file-path] ... Map a list of files into memory at startup time		s	X
ModMimeUsePathInfo On Off Tells MOD_MIME to treat <code>path.info</code> components as part of the filename	Off	d	B
MultiViewsMatch Any NegotiatedOnly Filters Handlers [Handlers Filters] The types of files that will be included when searching for a matching file with MultiViews	NegotiatedOnly	svdh	B
NameVirtualHost addr[:port] Designates an IP address for name-virtual hosting		s	C
NoProxy host [host] ... Hosts, domains, or networks that will be connected to directly		sv	E
NumServers number Total number of children alive at the same time	2	s	M
NWSSLTrustedCerts filename [filename] ... List of additional client certificates		s	B
NWSSLUpgradeable [IP-address:]portnumber Allows a connection to be upgraded to an SSL connection upon request		s	B
Options [+ -]option [+ -]option ... Configures what features are available in a particular directory	All	svdh	C
Order ordering Controls the default access state and the order in which ALLOW and DENY are evaluated.	Deny,Allow	dh	B
PassEnv env-variable [env-variable] ... Passes environment variables from the shell		svdh	B
PidFile filename File where the server records the process ID of the daemon	logs/httpd.pid	s	M
ProtocolEcho On Off Turn the echo server on or off		sv	X
<Proxy wildcard-url> ...</Proxy> Container for directives applied to proxied resources		sv	E
ProxyBadHeader IsError Ignore StartBody Determines how to handle bad header lines in a response	IsError	sv	E
ProxyBlock * word host domain [word host domain] ... Words, hosts, or domains that are banned from being proxied		sv	E
ProxyDomain Domain Default domain name for proxied requests		sv	E
ProxyErrorOverride On Off Override error pages for proxied content	Off	sv	E
ProxyFtpDirCharset character set Define the character set for proxied FTP listings	ISO-8859-1	svd	E
ProxyIOBufferSize bytes Determine size of internal data throughput buffer	8192	sv	E
<ProxyMatch regex> ...</ProxyMatch> Container for directives applied to regular-expression-matched proxied resources		sv	E
ProxyMaxForwards number Maximum number of proxies that a request can be forwarded through	10	sv	E
ProxyPass [path] ! url Maps remote servers into the local server URL-space		svd	E

ProxyPassReverse [path] url Adjusts the URL in HTTP response headers sent from a reverse proxied server		svd	E	p. 514
ProxyPreserveHost On Off Use incoming Host HTTP request header for proxy request	Off	sv	E	p. 514
ProxyReceiveBufferSize bytes Network buffer size for proxied HTTP and FTP connections	0	sv	E	p. 515
ProxyRemote match remote-server Remote proxy used to handle certain requests		sv	E	p. 515
ProxyRemoteMatch regex remote-server Remote proxy used to handle requests matched by regular expressions		sv	E	p. 515
ProxyRequests On Off Enables forward (standard) proxy requests	Off	sv	E	p. 516
ProxyTimeout seconds Network timeout for proxied requests	300	sv	E	p. 516
ProxyVia On Off Full Block Information provided in the Via HTTP response header for proxied requests	Off	sv	E	p. 516
ReadmeName filename Name of the file that will be inserted at the end of the index listing		svdh	B	p. 390
ReceiveBufferSize bytes TCP receive buffer size	0	s	M	p. 598
Redirect [status] URL-path URL Sends an external redirect asking the client to fetch a different URL		svdh	B	p. 350
RedirectMatch [status] regex URL Sends an external redirect based on a regular expression match of the current URL		svdh	B	p. 351
RedirectPermanent URL-path URL Sends an external permanent redirect asking the client to fetch a different URL		svdh	B	p. 351
RedirectTemp URL-path URL Sends an external temporary redirect asking the client to fetch a different URL		svdh	B	p. 351
RemoveCharset extension [extension] ... Removes any character set associations for a set of file extensions		vdh	B	p. 491
RemoveEncoding extension [extension] ... Removes any content encoding associations for a set of file extensions		vdh	B	p. 491
RemoveHandler extension [extension] ... Removes any handler associations for a set of file extensions		vdh	B	p. 492
RemoveInputFilter extension [extension] ... Removes any input filter associations for a set of file extensions		vdh	B	p. 492
RemoveLanguage extension [extension] ... Removes any language associations for a set of file extensions		vdh	B	p. 493
RemoveOutputFilter extension [extension] ... Removes any output filter associations for a set of file extensions		vdh	B	p. 493
RemoveType extension [extension] ... Removes any content type associations for a set of file extensions		vdh	B	p. 493
RequestHeader set append add unset header [value [env=[!]variable]] Configure HTTP request headers		svdh	E	p. 444
Require entity-name [entity-name] ... Selects which authenticated users can access a resource		dh	C	p. 330
RewriteBase URL-path Sets the base URL for per-directory rewrites		dh	E	p. 523
RewriteCond TestString CondPattern Defines a condition under which rewriting will take place		svdh	E	p. 525
RewriteEngine on off Enables or disables runtime rewriting engine	off	svdh	E	p. 528
RewriteLock file-path Sets the name of the lock file used for REWRITEMAP synchronization		s	E	p. 529
RewriteLog file-path Sets the name of the file used for logging rewrite engine processing		sv	E	p. 529
RewriteLogLevel Level Sets the verbosity of the log file used by the rewrite engine	0	sv	E	p. 530
RewriteMap MapName MapType:MapSource Defines a mapping function for key-lookup		sv	E	p. 530
RewriteOptions Options Sets some special options for the rewrite engine	MaxRedirects=10	svdh	E	p. 533
RewriteRule Pattern Substitution Defines rules for the rewriting engine		svdh	E	p. 534

<code>RLimitCPU seconds max [seconds max]</code>		svdh	C
Limits the CPU consumption of processes launched by Apache children		p. 330	
<code>RLimitMEM bytes max [bytes max]</code>		svdh	C
Limits the memory consumption of processes launched by Apache children		p. 331	
<code>RLimitNPROC number max [number max]</code>		svdh	C
Limits the number of processes that can be launched by processes launched by Apache children		p. 331	
<code>Satisfy Any All</code>	All	dh	C
Interaction between host-level access control and user authentication		p. 332	
<code>ScoreBoardFile file-path</code>	logs/apache_status	s	M
Location of the file used to store coordination data for the child processes		p. 598	
<code>Script method cgi-script</code>		svd	B
Activates a CGI script for a particular request method.		p. 347	
<code>ScriptAlias URL-path file-path directory-path</code>		sv	B
Maps a URL to a filesystem location and designates the target as a CGI script		p. 351	
<code>ScriptAliasMatch regex file-path directory-path</code>		sv	B
Maps a URL to a filesystem location using a regular expression and designates the target as a CGI script		p. 352	
<code>ScriptInterpreterSource Registry Registry-Strict Script</code>	Script	svdh	C
Technique for locating the interpreter for CGI scripts		p. 333	
<code>ScriptLog file-path</code>		sv	B
Location of the CGI script error logfile		p. 400	
<code>ScriptLogBuffer bytes</code>	1024	sv	B
Maximum amount of PUT or POST requests that will be recorded in the scriptlog		p. 401	
<code>ScriptLogLevel bytes</code>	10385760	sv	B
Size limit of the CGI script logfile		p. 401	
<code>ScriptSock file-path</code>	logs/cgisock	sv	B
The name of the socket to use for communication with the cgi daemon		p. 402	
<code>SecureListen [IP-address:]portnumber Certificate-Name [MUTUAL]</code>		s	B
Enables SSL encryption for the specified port		p. 503	
<code>SendBufferSize bytes</code>	0	s	M
TCP buffer size		p. 599	
<code>ServerAdmin email-address</code>		sv	C
Email address that the server includes in error messages sent to the client		p. 333	
<code>ServerAlias hostname [hostname] ...</code>		v	C
Alternate names for a host used when matching requests to name-virtual hosts		p. 334	
<code>ServerLimit number</code>		s	M
Upper limit on configurable number of processes		p. 599	
<code>ServerName fully-qualified-domain-name[:port]</code>		sv	C
Hostname and port that the server uses to identify itself		p. 334	
<code>ServerPath URL-path</code>		v	C
Legacy URL pathname for a name-based virtual host that is accessed by an incompatible browser		p. 335	
<code>ServerRoot directory-path</code>	/usr/local/apache	s	C
Base directory for the server installation		p. 335	
<code>ServerSignature On Off EMail</code>	Off	svdh	C
Configures the footer on server-generated documents		p. 335	
<code>ServerTokens Major Minor Min[imal] Prod[uctOnly] OS Full</code>	Full	s	C
Configures the Server HTTP response header		p. 336	
<code>SetEnv env-variable value</code>		svdh	B
Sets environment variables		p. 426	
<code>SetEnvIf attribute regex [!]env-variable[=value] [!]env-variable[=value] ...</code>		svdh	B
Sets environment variables based on attributes of the request		p. 542	
<code>SetEnvIfNoCase attribute regex [!]env-variable[=value] [!]env-variable[=value] ...</code>		svdh	B
Sets environment variables based on attributes of the request without respect to case		p. 544	
<code>SetHandler handler-name None</code>		svdh	C
Forces all matching files to be processed by a handler		p. 336	
<code>SetInputFilter filter[;filter...]</code>		svdh	C
Sets the filters that will process client requests and POST input		p. 337	
<code>SetOutputFilter filter[;filter...]</code>		svdh	C
Sets the filters that will process responses from the server		p. 337	
<code>SSIEndTag tag</code>	"->"	sv	B
String that ends an include element		p. 456	
<code>SSIErrorMsg message</code>	"[an error occurred +	svdh	B
Error message displayed when there is an SSI error		p. 456	

SSIStartTag <i>tag</i>	"<!-#"	sv	B
String that starts an include element			p. 457
SSLTimeFormat <i>formatstring</i>	"%A, %d-%b-%Y %H:%M +"	svdh	B
Configures the format in which date strings are displayed			p. 457
SSLUndefinedEcho <i>string</i>	"(none)"	sv	B
String displayed when an unset variable is echoed			p. 458
SSLCACertificateFile <i>file-path</i>		sv	E
File of concatenated PEM-encoded CA Certificates for Client Auth			p. 551
SSLCACertificatePath <i>directory-path</i>		sv	E
Directory of PEM-encoded CA Certificates for Client Auth			p. 551
SSLCARevocationFile <i>file-path</i>		sv	E
File of concatenated PEM-encoded CA CRLs for Client Auth			p. 552
SSLCARevocationPath <i>directory-path</i>		sv	E
Directory of PEM-encoded CA CRLs for Client Auth			p. 552
SSLCertificateChainFile <i>file-path</i>		sv	E
File of PEM-encoded Server CA Certificates			p. 552
SSLCertificateFile <i>file-path</i>		sv	E
Server PEM-encoded X.509 Certificate file			p. 553
SSLCertificateKeyFile <i>file-path</i>		sv	E
Server PEM-encoded Private Key file			p. 553
SSLCipherSuite <i>cipher-spec</i>	ALL:!ADH:RC4+RSA:+H +	svdh	E
Cipher Suite available for negotiation in SSL handshake			p. 554
SSLEngine <i>on off</i>	off	sv	E
SSL Engine Operation Switch			p. 556
SSLMutex <i>type</i>	none	s	E
Semaphore for internal mutual exclusion of operations			p. 557
SSLOptions <i>[+ -]option ...</i>		svdh	E
Configure various SSL engine run-time options			p. 558
SSLPassPhraseDialog <i>type</i>	builtin	s	E
Type of pass phrase dialog for encrypted private keys			p. 559
SSLProtocol <i>[+ -]protocol ...</i>	all	sv	E
Configure usable SSL protocol flavors			p. 560
SSLProxyCACertificateFile <i>file-path</i>		sv	E
File of concatenated PEM-encoded CA Certificates for Remote Server Auth			p. 561
SSLProxyCACertificatePath <i>directory-path</i>		sv	E
Directory of PEM-encoded CA Certificates for Remote Server Auth			p. 561
SSLProxyCARevocationFile <i>file-path</i>		sv	E
File of concatenated PEM-encoded CA CRLs for Remote Server Auth			p. 561
SSLProxyCARevocationPath <i>directory-path</i>		sv	E
Directory of PEM-encoded CA CRLs for Remote Server Auth			p. 562
SSLProxyCipherSuite <i>cipher-spec</i>	ALL:!ADH:RC4+RSA:+H +	svdh	E
Cipher Suite available for negotiation in SSL proxy handshake			p. 562
SSLProxyEngine <i>on off</i>	off	sv	E
SSL Proxy Engine Operation Switch			p. 562
SSLProxyMachineCertificateFile <i>filename</i>		s	E
File of concatenated PEM-encoded client certificates and keys to be used by the proxy			p. 563
SSLProxyMachineCertificatePath <i>directory</i>		s	E
Directory of PEM-encoded client certificates and keys to be used by the proxy			p. 563
SSLProxyProtocol <i>[+ -]protocol ...</i>	all	sv	E
Configure usable SSL protocol flavors for proxy usage			p. 563
SSLProxyVerify <i>level</i>	none	svdh	E
Type of remote server Certificate verification			p. 564
SSLProxyVerifyDepth <i>number</i>	1	svdh	E
Maximum depth of CA Certificates in Remote Server Certificate verification			p. 564
SSLRandomSeed <i>context source [bytes]</i>		s	E
Pseudo Random Number Generator (PRNG) seeding source			p. 565
SSLRequire <i>expression</i>		dh	E
Allow access only when an arbitrarily complex boolean expression is true			p. 566
SSLRequireSSL		dh	E
Deny access when SSL is not used for the HTTP request			p. 568
SSLSessionCache <i>type</i>	none	s	E
Type of the global/inter-process SSL Session Cache			p. 569
SSLSessionCacheTimeout <i>seconds</i>	300	sv	E
Number of seconds before an SSL session expires in the Session Cache			p. 569

SSLUserName <i>varname</i>		sdh	E
Variable name to determine user name		p. 570	
SSLVerifyClient <i>level</i>	none	svdh	E
Type of Client Certificate verification		p. 570	
SSLVerifyDepth <i>number</i>	1	svdh	E
Maximum depth of CA Certificates in Client Certificate verification		p. 571	
StartServers <i>number</i>		s	M
Number of child server processes created at startup		p. 600	
StartThreads <i>number</i>		s	M
Number of threads created on startup		p. 600	
SuexecUserGroup <i>User Group</i>		sv	E
User and group permissions for CGI programs		p. 574	
ThreadLimit <i>number</i>		s	M
Sets the upper limit on the configurable number of threads per child process		p. 600	
ThreadsPerChild <i>number</i>		s	M
Number of threads created by each child process		p. 601	
ThreadStackSize <i>number</i>	65536	s	M
Determine the stack size for each thread		p. 605	
TimeOut <i>seconds</i>	300	sv	C
Amount of time the server will wait for certain events before failing a request		p. 338	
TraceEnable [on off extended]	on	s	C
Determines the behaviour on TRACE requests		p. 338	
TransferLog <i>file pipe</i>		sv	B
Specify location of a log file		p. 475	
TypesConfig <i>file-path</i>	conf/mime.types	s	B
The location of the mime.types file		p. 494	
UnsetEnv <i>env-variable [env-variable] ...</i>		svdh	B
Removes variables from the environment		p. 427	
UseCanonicalName On Off DNS	On	svd	C
Configures how the server determines its own name and port		p. 339	
User <i>unix-userid</i>	#-1	s	M
The userid under which the server will answer requests		p. 601	
UserDir <i>directory-filename</i>	public.html	sv	B
Location of the user-specific directories		p. 577	
VirtualDocumentRoot <i>interpolated-directory none</i>	none	sv	E
Dynamically configure the location of the document root for a given virtual host		p. 587	
VirtualDocumentRootIP <i>interpolated-directory none</i>	none	sv	E
Dynamically configure the location of the document root for a given virtual host		p. 587	
<VirtualHost <i>addr[:port] [addr[:port]] ...</i> > ... </VirtualHost>		s	C
Contains directives that apply only to a specific hostname or IP address		p. 339	
VirtualScriptAlias <i>interpolated-directory none</i>	none	sv	E
Dynamically configure the location of the CGI directory for a given virtual host		p. 587	
VirtualScriptAliasIP <i>interpolated-directory none</i>	none	sv	E
Dynamically configure the location of the cgi directory for a given virtual host		p. 588	
Win32DisableAcceptEx		s	M
Use accept() rather than AcceptEx() to accept network connections		p. 615	
XBitHack on off full	off	svdh	B
Parse SSI directives in files with the execute bit set		p. 458	